

ACCESS SERVICE TARIFF  
PSCK NO. 2

CINCINNATI BELL TELEPHONE COMPANY LLC

2nd Revised Title Page (C)  
Cancels 1st Revised Title Page

REGULATIONS, RATES AND CHARGES

Applying to the provision of Access Services  
within a Local Access and Transport Area (LATA)  
within the operating territory of

CINCINNATI BELL TELEPHONE COMPANY LLC (C)

in the State of

Kentucky

as provided herein.

Access Service Tariff PSCK No. 2 Cancels and Supercedes  
Access Service Tariff PSCK No. 1.

This Tariff also includes Unbundled Network Elements applicable to carriers who are certified Competitive Local Exchange Carriers in Kentucky and who have executed an interconnection agreement with Cincinnati Bell Telephone Company LLC. (C)

PUBLIC SERVICE COMMISSION  
OF KENTUCKY  
EFFECTIVE  
04/25/2005  
PURSUANT TO 807 KAR 5:011  
SECTION 9 (1)

Issued: April 11, 2005

D. Scott Ringo, Jr., Assistant Secretary, Cincinnati, Ohio

By  Executive Director

TABLE OF CONTENTS

|   | <u>Page No.</u> |
|---|-----------------|
| REGISTERED SERVICE MARKS      REGISTERED TRADEMARKS                             | 17              |
| EXPLANATION OF SYMBOLS  | 18              |
| EXPLANATION OF ABBREVIATIONS  | 18              |
| REFERENCE TO OTHER TARIFFS  | 20              |
| REFERENCE TO PUBLICATIONS   | 20              |
| 1. <u>APPLICATION OF TARIFF</u>   | 23              |
| 2. <u>GENERAL REGULATIONS</u>   | 24              |
| 2.1 <u>Undertaking of the Teleuhone Company</u>                                 | 24              |
| 2.1.1 Scope   | 24              |
| 2.1.2 Limitations   | 25              |
| 2.1.3 Liability   | 26              |
| 2.1.4 Provision of Services   | 29              |
| 2.1.5 Installation and Termination of Services                                  | 29              |
| 2.1.6 Maintenance of Services   | 29              |
| 2.1.7 Changes and Substitutions   | 30              |
| 2.1.8 Refusal and Discontinuance of Service                                     | 31              |
| 2.1.9 Limitation of Use of Metallic Facilities                                  | 32              |
| 2.1.10 Notification of Service-Affecting Activities                             | 32              |
| 2.1.11 Coordination with Respect to Network Contingencies                       | 32              |
| 2.1.12 Provision and Ownership of Telephone Numbers                             | 33              |
| 2.1.13 Provision of Title Directory Listings in Connection<br>with FGA Services | 33              |
| 2.2 <u>Use</u>  | 33              |
| 2.2.1 Reserved  | 33              |
| 2.2.2 Interference or Impairment  | 33              |
| 2.2.3 Unlawful Use  | 34              |

PUBLIC SERVICE COMMISSION  
OF KENTUCKY  
EFFECTIVE

MAR 3 1992

PURSUANT TO 807 KAR 5:011,  
SECTION 9 (1)

BY: Sharon Deller  
PUBLIC SERVICE COMMISSION MANAGER

Effective: March 3, 1992

Issued: February 7, 1992

*Robert E. Aignone* for

President, Cincinnati, Ohio

Vice President - Regulatory Affairs



ACCESS SERVICE TARIFF  
PSCK No. 2

CINCINNATI BELL TELEPHONE COMPANY

1st Revised Page 2  
Cancels *Original* Page 2

TABLE OF CONTENTS (Cont'd)

|  | <u>Page No.</u> |     |
|--|-----------------|-----|
| 2. <u>GENERAL REGULATIONS</u> (Cont'd)   |                 |     |
| 2.3 <u>Oblinations of the Customer</u>   | 34              |     |
| 2.3.1 Damages  | 34              |     |
| 2.3.2 Ownership of Facilities and Theft  | 35              |     |
| 2.3.3 Equipment Space and Power  | 35              |     |
| 2.3.4 Reserved   | 35              |     |
| 2.3.5 Reserved   | 36              |     |
| 2.3.6 Availability for Testing   | 36              |     |
| 2.3.7 Balance  | 36              |     |
| 2.3.8 Design of Customer Services  | 36              |     |
| 2.3.9 References to the Telephone Company  | 37              |     |
| 2.3.10 Reserved  | 37              |     |
| 2.3.11 Claims and Demands for Damages  | 37              |     |
| 2.3.12 Reserved  | 38              |     |
| 2.3.13 Coordination with Respect to Network Contingencies  | 39              |     |
| 2.3.14 Jurisdictional Report Requirements  | 39              |     |
| 2.3.15 Determination of Intrastate Charges for Mixed<br>Interstate and Intrastate Access Service | 44              |     |
| 2.3.16 Certification of Special Access Services As Intrastate                                    | 45              |     |
| 2.4 <u>Payment Arrangements and Credit Allowances</u>  | 46              |     |
| 2.4.1 Payment of Rates, Charges and Deposits   | 46              |     |
| 2.4.2 Minimum Periods  | 54              |     |
| 2.4.3 Cancellation of an Order for Service   | 55              |     |
| 2.4.4 Credit Allowance for Service Interruptions   | 55              |     |
| 2.4.5 Service Installation Interval Guarantee  | 61.1            | (N) |
| 2.4.6 Reestablishment of Service Following Fire, Flood<br>or Other Occurrence                    | 62              |     |
| 2.4.7 Title or Ownership Rights  | 63              |     |
| 2.4.8 Reserved   | 63              |     |

PUBLIC SERVICE COMMISSION  
OF KENTUCKY  
EFFECTIVE

MAY 23 1995

PURSUANT TO 807 KAR 5.011,  
SECTION 9 (1)

BY: Jordan C. Heel  
FOR THE PUBLIC SERVICE COMMISSION

Issued: **June 13, 1995**

Effective: **May 23, 1995**

*Deborah A. Nisch*

President, Cincinnati, Ohio

Vice President  
Integrated Corporate Planning for

.ACCESS SERVICE TARIFF  
PSCK No. 2

CINCINNATI BELL TELEPHONE COMPANY

5th Revised Page 3  
Cancels 4rd Revised Page 3

TABLE OF CONTENTS (Cont'd)

|  | <u>Page No.</u> |
|--|-----------------|
| 2. <u>GENERAL REGULATIONS</u> (Cont'd)                       |                 |
| 2.5 <u>Connections</u>                                       | 64              |
| 2.5.1 General  | 64              |
| 2.6 <u>Definitions</u>                                       | 65              |
| Access Code  | 65              |
| Access Minutes   | 65              |
| Access Tandem  | 65              |
| Aggregator   | 65              |
| Answer/Disconnect Supervision                                | 66              |
| Attenuation Distortion                                       | 66              |
| Automatic Number Identification (ANI)                        | 66              |
| Balance (100 Type) Test Line                                 | 66              |
| Bit  | 66              |
| Business Day   | 67              |
| Call   | 68              |
| Call Gapping   | 68              |
| Carrier or Common Carrier                                    | 68              |
| Central Office   | 69              |
| Central Office Prefix  | 69              |
| Centralized Automatic Reporting on Trunks Testing            | 69              |
| Channel(s)   | 69              |
| Channel Service Unit   | 69              |
| Channel size   | 69              |
| C-Message Noise  | 70              |
| C-Notched Noise  | 70              |
| Coin Station   | 70              |
| Committed Information Rate                                   | 70              |
| Committed Burst Size   | 70              |
| Common Channel Signaling                                     | 70              |
| Common Channel Signaling Access Capability                   | 70 (C)          |
| Common Channel Signaling Access Capability<br>Signaling Link | 70.1 (C)        |
| Common Line  | 70.1 (C)        |
| Communications System  | 70.1 (C)        |
| Conventional Signaling                                       | 70.1 (C)        |
| Customer(s)  | 71 (C)          |
| Data Base Query  | 71 (C)          |
| Data Transmission (107 Type) Test                            | 71 (C)          |
| Decibel  | 71 (C)          |

Issued: March 25, 1999

Effective: January 25, 1999

President, Cincinnati, Ohio

TABLE OF CONTENTS (Cont'd)

|  | <u>Page No.</u> |
|--|-----------------|
| <u>GENERAL REGULATIONS</u> (Cont'd)                      |                 |
| 2.6 <u>Definitions</u> (Cont'd)                          |                 |
| Decibel Reference Noise C-Message Weighing               | 71              |
| Decibel Reference Noise C-Message Referenced to 0        | 71              |
| Detail Billing   | 71              |
| Direct-Trunked Transport Facility                        | 72              |
| Directory Assistance (Intrastate InterLATA)              | 72              |
| (C) Directory Assistance Location (Intrastate InterLATA) | 72              |
| Dual Tone Multifrequency Address Signaling               | 72              |
| Echo Control   | 72              |
| Echo Path Loss   | 72              |
| Echo Return Loss   | 73              |
| Effective 2-Wire   | 73              |
| Effective 4-Wire   | 73              |
| 800 Access Service                                       | 73              |
| Electronic Access  | 73              |
| End Office Switch  | 73              |
| End User   | 73              |
| Entrance Facility  | 74              |
| Entry Switch   | 74              |
| Envelope Delay Distortion                                | 74              |
| Equal Access Signaling                                   | 74              |
| Equal Level Echo Path Loss                               | 74              |
| Excess Burst Size (EBS)                                  | 74              |
| Expected Measured Loss                                   | 74              |
| Exchange   | 75              |
| Exit Message   | 75              |
| Field Identifier   | 75              |
| First-Come, First-Served                                 | 75              |
| First Point of Switching                                 | 75              |
| Flexible Automatic Number Identification (Flex ANI)      | 76              |
| Frame  | 76              |
| Frequency Shift  | 76              |
| Grandfathered  | 76              |
| Host Computer  | 76              |
| Host Office  | 77              |
| Hundred Call Seconds                                     | 77              |
| Immediately Available Funds                              | 77              |
| Impedance Balance  | 77              |
| Impulse Noise  | 77              |
| Individual Case Basis                                    | 77              |
| Initial Address Message                                  | 78              |

ACCESS SERVICE TARIFF  
PSCK No. 2

CINCINNATI BELT TELEPHONE COMPANY

2nd Revised Page 5  
Cancels 1st Revised Page 5

TABLE OF CONTENTS (Cont'd)

|  | <u>Page No.</u> |     |
|--|-----------------|-----|
| 2. <u>GENERAL REGULATIONS</u> (Cont'd)                     |                 |     |
| 2.6 <u>Definitions</u> (Cont'd)                            |                 |     |
| Inserted Connection Loss                                   | 78              |     |
| Interconnection Charge                                     | 78              | (N) |
| Interexchange Carrier (IC) or Interexchange Common Carrier | 78              |     |
| Intermodulation Distortion                                 | 78              |     |
| Interstate Communications                                  | 78              |     |
| Intrastate Communications                                  | 79              |     |
| Letter of Authorization                                    | 79              | (N) |
| Line-Side Connection                                       | 79              |     |
| Local Access and Transport Area                            | 79              |     |
| Local Tandem Switch  | 80              |     |
| Loop Around Test Line                                      | 80              |     |
| Loss Deviation   | 80              |     |
| Maritime Radio Common Carrier                              | 80              |     |
| Major Fraction Thereof                                     | 81              |     |
| Message  | 81              |     |
| Milliwatt (102 Type) Test Line                             | 81              |     |
| Mobile Telephone Switching Office                          | 81              |     |
| Network Control Signaling                                  | 82              |     |
| Network Management Control                                 | 82              |     |
| North American Numbering Plan                              | 82              |     |
| Off-Hook   | 82              |     |
| On-Hook  | 82              |     |
| Open Circuit Test Line                                     | 82              |     |
| Originating Direction                                      | 83              |     |
| Overlap Outpulsing   | 83              |     |
| Pay Telephone  | 83              |     |
| Peaked Service   | 83              |     |
| Phase Jitter   | 83              |     |
| Point of Termination                                       | 83              |     |
| Premises   | 83              |     |
| Prime Service Vendor                                       | 83              |     |
| Radio Common Carrier                                       | 84              |     |

PUBLIC SERVICE COMMISSION  
OF KENTUCKY  
EFFECTIVE

MAY 23 1995

PURSUANT TO 807 KAR 5.011,  
SECTION 9(1)

BY: Jonathan P. Neal  
FOR THE PUBLIC SERVICE COMMISSION

*Deborah Bush*  
Issued: June 13, 1995  
Vice President  
Integrated Corporate Planning for

President, Cincinnati, Ohio

Effective: May 23, 1995

TABLE OF CONTENTS (Cont'd)

|  | <u>Page No</u> |
|--|----------------|
| 2 <u>GENERAL REGULATIONS</u> (Cont'd)                    |                |
| 2.6 Definitions (Cont'd)                                 |                |
| Remote Switching Modules and/or Remote Switching Systems | 84             |
| Return Loss  | 84             |
| Registered Equipment                                     | 84             |
| Service Switching Point                                  | 84             |
| Serving Wire Center                                      | 84             |
| Seven Digit Manual Test Line                             | 85             |
| Short Circuit Test Line                                  | 85             |
| Signal-To-C-Notched Noise Ratio                          | 85             |
| Signaling Point of Interconnection                       | 85             |
| Signaling System 7                                       | 85.1           |
| Signaling Transfer Point                                 | 85.1           |
| Signaling Transfer Point Port Termination                | 85.1           |
| Singing Return Loss                                      | 85.1           |
| Special Order  | 85.1           |
| Subcontractor  | 85.1           |
| Subtending End Office of an Access Tandem                | 86             |
| Switching System   | 86             |
| Synchronous Optical Network (SONET)                      | 86 (N)         |
| Synchronous Test Line                                    | 86             |
| Synchronous Transport Signal                             | 86 (N)         |
| Tandem Switched Provider                                 | 86 (N)         |
| Tandem-Switched Transmission Charge                      | 86             |
| Tandem-Switching Charge                                  | 86             |
| Terminating Direction                                    | 86             |
| Transmission Measuring (105 Type) Test Line/Responder    | 87             |
| Transmission Path  | 87             |
| Trunk  | 87             |
| Trunk Access Limitation                                  | 87             |
| Trunk Group  | 87             |
| Trunk Side Connection                                    | 88             |
| Two-Wire to Four-Wire Conversion                         | 88             |
| Uniform Service Order Code                               | 88             |
| V and H Coordinates Method                               | 88             |
| WATS Serving Office                                      | 88             |
| Wire Center  | 88             |

ACCESS SERVICE TARIFF  
PSC No. 2

CINCINNATI BELL TELEPHONE COMPANY

1st Revised Page 7  
Cancels Original Page 7

TABLE OF CONTENTS (Cont'd)

|  | <u>Page No.</u> |
|--|-----------------|
| 3. CARRIER COMMON LINE ACCESS SERVICE    | 89              |
| 3.1 General Description                  | 89              |
| 3.2 Limitations                          | 90              |
| 3.3 Undertaking of the Telephone Company | 91              |
| 3.4 Obligations of the Customer          | 93              |
| 3.5 Payment Arrangements                 | 95              |
| 3.6 Reserved                             | 97 (T)          |
| 3.7 Rate Regulation                      | 100             |
| 3.8 Rates and Charges                    | 110             |
| 4. <u>Reserved</u>                       | 110             |

ACCESS SERVICE TARIFF  
PSCK No. 2

CINCINNATI BELL TELEPHONE COMPANY

2nd Revised Page 8  
Cancels 1st Revised Page 8

TABLE OF CONTENTS (Cont'd)

|  | <u>Page No.</u> |
|--|-----------------|
| 5. <u>ORDERING OPTIONS FOR SWITCHED AND SPECIAL ACCESS SERVICE</u> | 111             |
| 5.1 <u>General</u>   | 111             |
| 5.1.1 Ordering Conditions  | 111             |
| 5.1.2 Provision of Other Services                                  | 112             |
| 5.2 <u>Access Order</u>  | 113             |
| 5.2.1 Access Order Service Date Intervals                          | 118             |
| 5.2.2 Access Order Modifications                                   | 121             |
| 5.2.3 Cancellation of an Access Order                              | 126             |
| 5.2.4 Selection of Facilities For Access Orders                    | 128             |
| 5.2.5 Minimum Period   | 129             |
| 5.2.6 Minimum Period Charges                                       | 131             |
| 5.2.7 Shared Use Facilities  | 132             |
| 5.2.8 Switched Access Service To Cellular Interconnections         | 132             |
| 5.3 <u>Available Inventory</u>                                     | 133             |
| 5.4 <u>Reserved</u>  | 133             |
| 5.5 <u>'Access Order Standard Intervals</u>                        | 149             |
| 5.5.1 Reserved   | 150             |
| 5.5.2 Reserved   | 154             |
| 5.5.3 Reserved   | 155             |

PUBLIC SERVICE COMMISSION  
OF KENTUCKY  
EFFECTIVE

MAY 23 1995

PURSUANT TO 807 KAR 5.011,  
SECTION 9(1)  
BY: Jordan C. Neal  
FOR THE PUBLIC SERVICE COMMISSION

(D)  
|  
(D)

Issued: June 13, 1995

Effective: May 23, 1995

*Deborah A. Nisch* President, Cincinnati, Ohio  
Vice President  
Integrated Corporate Planning for .

ACCESS SERVICE TARIFF  
PSCK No. 2

CINCINNATI BELL TELEPHONE COMPANY

2nd Revised Page 9  
Cancels 1st Revised Page 9

TABLE OF CONTENTS (Cont'd)

|  | <u>Page No.</u> |  |
|--|-----------------|--|
| 6. <u>SWITCHED ACCESS SERVICE</u>  | 156             |  |
| 6.1 <u>General</u>   | 156             |  |
| 6.1.1 Switched Access Arrangements and Manner of Provision                     | 157             |  |
| 6.1.2 WATS Access Line Service   | 164             |  |
| 6.1.3 Rate Categories  | 165             | (T)  |
| 6.1.4 Special Facilities Routing   | 181             |  |
| 6.1.5 Design Layout Report   | 181             |  |
| 6.1.6 Acceptance Testing   | 181             |  |
| 6.1.7 Ordering Options and Conditions  | 182             |  |
| 6.1.8 CCSAC Testing Requirements   | 182             |  |
| 6.2 <u>Provision and Description of Switched Access Service Feature Groups</u> | 183             |  |
| 6.2.1 Feature Group A (FGA)  | 184             |  |
| 6.2.2 Feature Group B (FGB)  | 191             |  |
| 6.2.3 Reserved   | 195             |  |
| 6.2.4 Feature Group D (FGD)  | 196             |  |
| 6.3 <u>Local Switching Optional Features</u>                                   | 202             |  |
| 6.3.1 Common Switching   | 202             | PUBLIC SERVICE COMMISSION                                      |
| 6.3.2 Transport Termination  | 212             | OF KENTUCKY  |
| 6.3.3 WATS Access Line Termination   | 213             | EFFECTIVE  |
| 6.4 <u>Transmission Specifications</u>   | 214             |  |
| 6.4.1 Standard Transmission Specifications                                     | 215             |  |
| 6.4.2 Data Transmission Parameters   | 222             | MAY 23 1995<br>PURSUANT TO 807 KAR 5011,<br>SECTION 11.1       |
| 6.5 <u>Obligations of the Telephone Company</u>                                | 225             | BY: <u>Jordan L. Mail</u><br>FOR THE PUBLIC SERVICE COMMISSION |
| 6.5.1 Network Management   | 225             |  |
| 6.5.2 Design and Traffic Routing of Switched Access Service                    | 226             |  |
| 6.5.3 Provision of Service Performance Data                                    | 227             |  |
| 6.5.4 Trunk Group Measurement Reports  | 227             |  |
| 6.5.5 Determination of Number of Transmission Paths                            | 228             |  |
| 6.5.6 Determination of Number of End Office Transport Terminations             | 228             |  |
| 6.5.7 Design Blocking Probability  | 229             |  |

Issued: June 13, 1995

Effective: May 23, 1995

*Deborah A. Nisch* President, Cincinnati, Ohio  
Vice President  
Integrated Corporate Planning for



TABLE OF CONTENTS (Cont'd)

|  | <u>Page No.</u> |
|--|-----------------|
| 6. <u>SWITCHED ACCESS SERVICE</u> (Cont'd)             |                 |
| 6.6 <u>Obligations of the Customer</u>                 | 232             |
| 6.6.1 Report Requirements                              | 232             |
| 6.6.2 Supervisory Signaling                            | 234             |
| 6.6.3 Trunk Group Measurement Reports                  | 234             |
| 6.6.4 Design of Switched Access Services               | 234             |
| 6.7 <u>Rate Regulations</u>                            | 235             |
| 6.7.1 Description and Application of Rates and Charges | 235             |
| 6.7.2 Minimum Periods                                  | 240             |
| 6.7.3 Reserved   | 240             |
| 6.7.4 Minimum Monthly Charge                           | 241             |
| 6.7.5 Rate Zones                                       | 243 (N)         |
| 6.7.6 Change of Feature Group Type                     | 244             |
| 6.7.7 Moves  | 245             |
| 6.7.8 Measuring Access Minutes                         | 246             |
| 6.7.9 Network Blocking Charge for Feature Group D      | 252             |
| 6.7.10 Application of Rates for Extension Service      | 253             |
| 6.7.11 Message Unit Credit                             | 254             |
| 6.7.12 Local Information Delivery Services             | 254             |
| 6.7.13 Mileage Measurement                             | 255             |
| 6.7.14 Shared Use                                      | 258             |
| 6.7.15 Equal Access Recovery Charge                    | 258.1           |
| 6.7.16 Information Surcharge                           | 259             |
| 6.7.17 Data Base Query                                 | 259             |
| 6.8 <u>Rates and Changes</u>                           | 260             |
| 6.8.1 Interconnection Charge                           | 260             |
| 6.8.2 Switched Transport                               | 260             |
| 6.8.3 Local Switching                                  | 263             |
| 6.8.4 Reserved   | 272             |
| 6.8.5 Reserved   | 272             |
| 6.8.6 Message Unit Credit                              | 273             |
| 6.8.7 Equal Access Recovery Charge                     | 274             |
| 6.8.8 Information Surcharge                            | 274             |
| 6.8.9  | 274             |
| 6.8.10 900 Access Service                              | 275             |
| 6.8.11 500 Access Service                              | 275.1 (N)       |

ACCESS SERVICE TARIFF  
PSCK No. 2

CINCINNATI BELL TELEPHONE COMPANY

3rd Revised Page 11  
Cancels 2nd Revised Page 11

TABLE OF CONTENTS (Cont'd)

|  | <u>Page No</u> |
|--|----------------|
| 7. <u>SPECIAL ACCESS SERVICE</u>   | 276            |
| 7.1 <u>General</u>   | 276            |
| 7.1.1 Channel Types  | 276            |
| 7.1.2 Rate Categories  | 279            |
| 7.1.3 Service Configurations   | 282            |
| 7.1.4 Alternate Use  | 290            |
| 7.1.5 Special Facilities Routing   | 290            |
| 7.1.6 Design Layout Report   | 290            |
| 7.1.8 Ordering Options and Conditions  | 291            |
| 7.2 <u>Service Descriptions</u>  | 292            |
| 7.2.1 Metallic Service   | 295            |
| 7.2.2 Telegraph Grade Service  | 297            |
| 7.2.3 Voice Grade Service  | 298            |
| 7.2.4 Program Audio Service  | 310            |
| 7.2.5 Reserved   | 312            |
| 7.2.6 Reserved   | 312            |
| 7.2.7 Reserved   | 312            |
| 7.2.8 Digital Data Service   | 312            |
| 7.2.9 High Capacity Service  | 316            |
| 7.2.10 Customer Network Reconfiguration Service (CNRS)                       | 322            |
| 7.2.11 OC-3, OC-12, and OC-48 Service - Point-to-Point Service               | 323.1          |
| 7.2.12 OC-3, OC-12, and OC-48 Service - Dedicated Ring                       | 323.14 (C)     |
| 7.2.13 Shared SONET Service  | 323.27         |
| 7.3 <u>Reserved</u>  | 324            |
| 7.4 <u>Rate Regulations</u>  | 324            |
| 7.4.1 Types of Rates and Charges   | 325            |
| 7.4.2 Surcharge for Special Access Service                                   | 329            |
| 7.4.3 Rate Zones   | 334            |
| 7.4.4 Minimum Periods  | 335            |
| 7.4.5 Moves  | 335            |
| 7.4.6 Mileage Measurement 336 7.4.7 Facility Hubs 337                        |                |
| 7.4.8 Shared Used High Capacity Services and OC-3, OC-12, and OC-48 Services | 340            |

ACCESS SERVICE TARIFF  
PSC No. 2

CINCINNATI BELL TELEPHONE COMPANY

4th Revised Page 12  
Cancels 3rd Revised Page 12

TABLE OF CONTENTS (Cont'd)

|  | <u>Page No.</u> |
|--|-----------------|
| 7. <u>SPECIAL ACCESS SERVICE</u> (Cont'd)  |                 |
| 7.4 <u>Rate Regulations</u> (Cont'd)   |                 |
| 7.4.9 Payment Plans for Frame Relay Service, Digital Data Service MercNET45 High Capacity Services, 1.544 High Capacity Service, and OC-3, OC-12, and OC-48 Service and Shared SONET Service | 341             |
| 7.4.10 MercNET 45 High Capacity Service - 12 Pack Arrangement  | 343.1           |
| 7.4.11 Customer Network Reconfiguration Service (CNRS)   | 344             |
| 7.4.12 Discount Commitment Program (DCP)   | 344.1           |
| 7.5 <u>Rates and Charges</u>   |                 |
| 7.5.1 Metallic Service   | 345             |
| 7.5.2 Telegraph Grade Service  | 346             |
| 7.5.3 Voice Grade Service  | 347             |
| 7.5.4 Program Audio Service  | 354             |
| 7.5.5 Video Services   | 358             |
| 7.5.6 Reserved   | 358             |
| 7.5.7 Reserved   | 358             |
| 7.5.8 Digital Data Service   | 358             |
| 7.5.9 High Capacity Service  | 362             |
| 7.5.10 Customer Network Reconfiguration Service (CNRS)   | 369             |
| 7.5.11 Special Access Surcharge  | 369             |
| 7.5.12 OC-3, OC-12, OC-48 Service - Point-to-Point Service   | 369.1           |
| 7.5.13 OC-3, OC-12, OC-48 Service - Dedicated Ring   | 369.7           |
| (C) 7.5.14 Shared SONET Service  | 369.10          |
| 8. <u>BILLING AND COLLECTION SERVICES</u>  | 370             |
| 8.1 <u>Recording Service</u>   | 370             |
| 8.1.1 General Description  | 371             |
| 8.1.2 Undertaking of the Telephone Company   | 372             |
| 8.1.3 Liability of the Telephone Company   | 375.1           |
| 8.1.4 Obligations of the Customer  | 377             |
| 8.1.5 Payment Arrangements and Audit Provision   | 378             |
| 8.1.6 Rate Regulations   | 380             |
| 8.1.7 Rates and Charges  | 382             |
| 8.2 <u>Billing Service</u>   | 383             |
| 8.2.1 Message Billing Service  | 383             |
| 8.2.2  |                 |
| 8.2.3 Purchase of Accounts Receivable  | 454             |
| 8.2.4 Billing Arrangements when the Telephone Company Acts as Billing Agent for the Customer   | 463             |

Issued: March 25, 1999

Effective: January 25, 1999

President, Cincinnati, Ohio

ACCESS SERVICE TARIFF  
PSCK No. 2

CINCINNATI BELL TELEPHONE COMPANY

Original Page 13

TABLE OF CONTENTS (Cont'd)

|  | <u>Page No.</u> |
|--|-----------------|
| 8. <u>BILLING AND COLLECTION SERVICES</u> (Cont'd) |                 |
| 8.3 <u>Billing Analysis Service</u>                | 464             |
| 8.3.1 General Description                          | 464             |
| 8.3.2 Undertaking of the Telephone Company         | 465             |
| 8.3.3 Liability of the Telephone Company           | 472             |
| 8.3.4 Obligations of the IC                        | 472             |
| 8.3.5 Payment Arrangements                         | 474             |
| 8.3.6 Rate Regulations                             | 475             |
| 8.3.7 Rates and Charges                            | 477             |
| 8.4 <u>Billing Information Service</u>             | 478             |
| 8.4.1 General Description                          | 478             |
| 8.4.2 Undertaking of the Telephone Company         | 478             |
| 8.4.3 Liability of the Telephone Company           | 486             |
| 8.4.4 Obligations of the Customer                  | 487             |
| 8.4.5 Payment Arrangements                         | 489             |
| 8.4.6 Rate Regulations                             | 490             |
| 8.4.7 Rates and Charges                            | 492             |

PUBLIC SERVICE COMMISSION  
OF KENTUCKY  
EFFECTIVE

MAR 3 1992

PURSUANT TO 807 KAR 5:011,  
SECTION 9 (1)

BY:   
PUBLIC SERVICE COMMISSION MANAGER

Issued: February 7, 1992

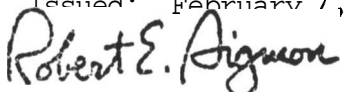
 for President, Cincinnati, Ohio

Vice President - Regulatory Affairs

ACCESS SERVICE TARIFF  
PSCK No. 2

CINCINNATI BELL TELEPHONE COMPANY

Original Page 14

TABLE OF CONTENTS (Cont'd)

|   | <u>Page No.</u> |
|---|-----------------|
| 9. <u>DIRECTORY ASSISTANCE SERVICE</u>                            | 494             |
| 9.1 <u>General Description</u>                                    | 494             |
| 9.2 <u>Undertaking of the Telephone Company</u>                   | 494             |
| 9.3 <u>Obligations of the Customer</u>                            | 501             |
| 9.4 <u>Payment Arrangements</u>                                   | 502             |
| 9.5 <u>Rate Regulations</u>                                       | 506             |
| 9.6 <u>Rates and Charges</u>                                      | 507             |
| 10. <u>FEDERAL GOVERNMENT SPECIALIZED SERVICE OR ARRANGEMENTS</u> | 508             |
| 10.1 <u>General</u>   | 508             |
| 10.2 <u>Emergency Conditions</u>                                  | 508             |
| 10.3 <u>Intervals to Provide Service</u>                          | 509             |
| 10.4 <u>Safeauardina of Service</u>                               | 510             |
| 10.4.1 <u>Facility Availability</u>                               | 510             |
| 10.4.2 <u>Utilization of Government Owned Facilities</u>          | 510             |
| 10.5 <u>Federal Government Regulations</u>                        | 510             |
| 10.6 <u>Mileage Application</u>                                   | 510             |
| 10.7 <u>Move Charges</u>  | 511             |
| 10.8 <u>Service Offerinas</u>                                     | 512             |
| 10.8.1 <u>Type and Description</u>                                | 512             |
| 10.8.2 <u>Rates and Charges</u>                                   | 512             |

PUBLIC SERVICE COMMISSION  
OF KENTUCKY  
EFFECTIVE

MAR 3 1992

PURSUANT TO 807 KAR 5:011,  
SECTION 9 (1)

BY: Cheryl Sallee  
PUBLIC SERVICE COMMISSION MANAGER, 1992

Issued: February 7, 1992

Robert E. Aigmon for President, Cincinnati, Ohio

Vice President - Regulatory Affairs

ACCESS SERVICE TARIFF  
PSC No. 2

CINCINNATI BELL TELEPHONE COMPANY

Original Page 15

TABLE OF CONTENTS (Cont'd)

|  | <u>Page No.</u> |
|--|-----------------|
| 11. <u>SPECIAL FACILITIES ROUTING OF ACCESS SERVICES</u>                       | 521             |
| 11.1 <u>Description of Special Facilities Routing of Access Services</u>       | 521             |
| 11.1.1 Diversity   | 521             |
| 11.1.2 Avoidance   | 521             |
| 11.1.3 Cable-Only Facilities   | 521             |
| 11.2 <u>Rates and Charges for Special Facilities Routing of Access Service</u> | 522             |
| 11.2.1 Diversity   | 522             |
| 11.2.2 Avoidance   | 523             |
| 11.2.3 Diversity and Avoidance Combined  | 523             |
| 11.2.4 Cable-Only Facilities   | 523             |
| 12. <u>SPECIALIZED SERVICE OR ARRANGEMENTS</u>                                 | 524             |
| 12.1 General   | 524             |
| 12.2 Move Charges  | 524             |
| 12.3 Simplified Message Desk Interface (SMDI)                                  | 525             |
| 12.3.1 Description of Service  | 525             |
| 12.3.2 Regulations   | 526             |
| 12.3.3 Rates   | 528             |

PUBLIC SERVICE COMMISSION  
OF KENTUCKY  
EFFECTIVE

MAR 3 1992

PURSUANT TO 807 KAR 5:011,  
SECTION 9 (1)

BY: Shayla Belle  
PUBLIC SERVICE COMMISSION MANAGER

Issued: February 7, 1992

Effective: March 3, 1992

Robert E. Aiguon for

President, Cincinnati, Ohio

Vice President - Regulatory Affairs

ACCESS SERVICE TARIFF  
PSC No. 2

CINCINNATI BELL TELEPHONE COMPANY

3rd Revised Page 16  
Cancels 2nd Revised Page 16

TABLE OF CONTENTS (Cont'd)

|      | <u>ADDITIONAL ENGINEERING, ADDITIONAL LABOR AND MISCELLANEOUS SERVICES</u> | <u>Page No.</u> |     |
|------|--|-----------------|-----|
| 13.  | <u>MISCELLANEOUS SERVICES</u>  | 529             |     |
|      | 13.1 <u>Additional Engineering</u>   | 529             |     |
|      | 13.1.1 Charges for Additional Engineering                                  | 529             |     |
|      | 13.2 <u>Additional Labor</u>   | 530             |     |
|      | 13.2.1 Overtime Installation   | 530             |     |
|      | 13.2.2 Overtime Repair   | 530             |     |
|      | 13.2.3 Stand by  | 530             |     |
|      | 13.2.4 Testing and Maintenance with Other Telephone Companies              | 531             |     |
|      | 13.2.5 Other Labor   | 531             |     |
|      | 13.2.6 Charges for Additional Labor  | 531             |     |
| 13.3 | <u>Miscellaneous Services</u>  | 534             | (C) |
|      | 13.3.1 Maintenance of Service  | 534             |     |
|      | 13.3.2 Reserved  | 536             |     |
|      | 13.3.3 Reserved  | 536             |     |
|      | 13.3.4 Standard Jacks - Registration Program                               | 537             |     |
|      | 13.3.5 Testing Services  | 545             |     |
|      | 13.3.6 Provision of Access Service Billing Information                     | 567             |     |
|      | 13.3.7 International Blocking Service                                      | 568.1           |     |
| 14.  | <u>RESERVED</u>  | 569             |     |
| 15   | <u>RATE CENTERS</u>  | 570             |     |
| 16.  | <u>Alarm Services</u>  | 571             |     |
|      | 16.1 <u>General</u>  | 571             |     |
|      | 16.1.1 Nonrecurring Charges  | 571             |     |
|      | 16.1.2 Service Configuration   | 573             |     |
|      | 16.1.3 Mileage Measurements  | 577             |     |
|      | 16.1.4 Definitions   | 579             |     |
|      | Central Office Termination   | 579             |     |
|      | Channel Terminal   | 579             |     |
|      | Full-Duplex Service  | 579             |     |
|      | Half-Duplex Service  | 579             |     |
|      | Interexchange Channel  | 579             |     |
|      | Interexchange Special Access Service                                       | 580             |     |
|      | Interoffice Channel  | 580             |     |
|      | Intraexchange Channel  | 580             |     |
|      | Local Channel  | 580             |     |
|      | Rate Center Central Office   | 580             |     |
|      | 16.2 <u>Service Description</u>  | 581             |     |
|      | 16.2.1 Alarm Services  | 581             |     |
|      | 16.3 <u>Rate Classification And Rates</u>                                  | 583             |     |
|      | 16.3.1 Type of Regulations and Charges                                     | 583             |     |
|      | 16.3.2 Conditioning  | 583             |     |
|      | 16.4 <u>Special Exchange Area</u>  | 591             |     |

ACCESS SERVICE TARIFF  
PSCK No. 2

CINCINNATI BELL TELEPHONE COMPANY

3rd Revised Page 17  
Cancels 2nd Revised Page 17

TABLE OF CONTENTS (Cont'd)

|   | <u>Page No.</u> |     |
|---|-----------------|-----|
| 17. <u>LAN ADVANTAGE FRAME RELAY<sup>SM</sup> SERVICE</u> | 592             |     |
| 17.1 <u>Service Description</u>                           | 592             |     |
| 17.2 <u>Service Provisioning</u>                          | 594             |     |
| 17.3 <u>Undertaking of the Phone Company</u>              | 594             |     |
| 17.4 <u>Obligations of the Customer</u>                   | 594             |     |
| 17.5 <u>Rate Regulations</u>                              | 595             |     |
| 17.6 <u>Rates and Charges</u>                             | 597             |     |
| 18. <u>RATE ZONE WIRE CENTER</u>                          | 598             |     |
| 18.1 <u>General</u>                                       | 598             |     |
| 19. <u>UNBUNDLED NETWORK ELEMENTS*</u>                    | 600             | (N) |
| 19.1 Unbundled Network Element Rates                      | 600             |     |
| 19.2 Unbundled Network Elements                           | 600             |     |
| 19.2.1 Transport and Termination                          | 600             |     |
| 19.2.2 BLV/BLVI Traffic Transport and Termination         | 600             |     |
| 19.2.3 Transit Service                                    | 600             |     |
| 19.2.4 Unbundled Network Elements                         | 601             |     |
| 19.2.5 E911 Service                                       | 622             |     |
| 19.2.6 Collocation  | 623             |     |

\* Unbundled Network Elements are only applicable to carriers who are certified competitive Local Exchange Carriers in Kentucky and who have executed an interconnection agreement with Cincinnati Bell Telephone. Issued pursuant to Commission Order in Administrative Case No. 382.(N)

Issued: July 3, 2003

President, Cincinnati, Ohio

Effective: July 3, 2003  
PURSUANT TO 807 KAR 5:011  
SECTION 9(1)

BY   
EXECUTIVE DIRECTOR

JUL 03 2003



ACCESS SERVICE TARIFF  
PSC No. 2

CINCINNATI BELL TELEPHONE COMPANY

Original Page 17.1

REGISTERED SERVICE MARKS

REGISTERED TRADEMARKS

(M)

MercNET 45

None

MercNET 1.5

None

—  
(M)

Material on this page was formerly found on page 17.

---

Issued: February 23, 1999

Effective: January 25, 1999

President, Cincinnati, Ohio

ACCESS SERVICE TARIFF  
PSC No. 2

CINCINNATI BELL TELEPHONE COMPANY

2nd Revised Page 18  
Cancels 1st Revised Page 18

EXPLANATION OF SYMBOLS

- (C) - To signify changed regulation
- (D) - To signify discontinued rate or regulation
- (I) - To signify increase
- (N) - To signify new rate or regulation
- (R) - To signify reduction
- (S) - To signify reissued matter
- (T) - To signify a change in text but no change in rate or regulation

EXPLANATION OF ABBREVIATIONS

- ac - Alternating current
- AML - Actual Measured Loss
- ANI - Automatic Number Identification
- AP - Program Audio
- AT&T-C - AT&T Communications
- BD - Business Day
- BHMC - Busy Hour Minutes of Capacity
- CAROT - Centralized Automatic Reporting on Trunks
- CCS - Common Channel Signaling
- CCSAC - Common Channel Signaling Access Capability
- CI - Channel Interface
- CN - Charge Number
- CO - Central Office
- COCTX - Central Office Centrex
- Cont'd - Continued
- CPE - Customer Provided Equipment
- CPN - Calling Party Number
- CSP - Carrier Selection Parameter
- CT - Channel Termination
- Ctx - Centrex
- DA - Directory Assistance
- db - decibel
- dBrnC - Decibel Reference Noise C-Message Weighting
- dBrnC0 - Decibel Reference Noise C-Message Weighted to 0
- dBv - Decibel(s) Relative to 1 volt (Reference)
- dBv1 - Decibel(s) Relating to 1 volt (Reference)
- dc - direct current
- NECA - National Exchange Carrier Association
- EDD - Envelope Delay Distortion
- EF - Entrance Facility
- ELEPL - Equal Level Echo Path Loss
- EML - Expected Measured Loss
- EPL - Echo Path Loss
- ERL - Echo Return Loss
- ESS - Electronic Switching System
- ESSX - Electronic Switching System Exchange
- f - frequency

PUBLIC SERVICE COMMISSION  
OF KENTUCKY  
EFFECTIVE

(N)

MAY 23 1995

PURSUANT TO 807 KAR 5.011,  
SECTION 9(1)

BY: Justin C. Neal  
FOR THE PUBLIC SERVICE COMMISSION

Issued: June 13, 1995

Effective: May 23, 1995

Deborah A. Nisch President, Cincinnati, Ohio

Vice President  
Integrated Corporate Planning for

ACCESS SERVICE TARIFF  
PSC No. 2

CINCINNATI BELL TELEPHONE COMPANY

2nd Revised Page 19  
Cancels 1st Revised Page 19

EXPLANATION OF ABBREVIATIONS (Cont'd)

F.C.C. or  
FCC - Federal Communications Commission  
FID - Field Identifier  
FX - Foreign Exchange  
HC - High Capacity  
Hz - Hertz  
IAM - Initial Address Message  
IC - Interexchange Carrier  
ICB - Individual Case Basis  
ICL - Inserted Connection Loss  
kbps - kilobits per second  
kHz - kilohertz  
LATA - Local Access and Transport Area  
Ma - milliamperes  
Mbps - Megabits per second  
MHz - Megahertz  
MMUC - Minimum Monthly Usage Charge  
MRC - Monthly Recurring Charge  
MRCC - Maritime Radio Common Carrier(s)  
MT - Metallic  
MTS - Message Telecommunications Service(s)  
MTSO - Mobile Telephone Switching Office  
NPA - Numbering Plan Area  
NRC - Nonrecurring Charge  
NTS - Non-Traffic Sensitive  
NXX - Three-Digit Central Office Code  
PBX - Private Branch Exchange  
PCM - Pulse Code Modulation  
PI - Priority Installation  
PLR - Private Line Ringdown  
POT - Point of Termination  
PR - Priority Restoration  
RCC - Radio Common Carrier(s)  
rms - root-mean-square  
RSM - Remote Switching Modules  
RSS - Remote Switching Systems  
SSP - Service Switching Point  
SP - Signaling Point  
SPOI - Signaling Point of Interconnection  
SRL - Singing Return Loss  
SSN - Switched Service Network  
SS7 - Signaling System 7  
STP - Signaling Transfer Point  
SWC - Serving Wire Center  
TES - Telephone Exchange Service(s)

PUBLIC SERVICE COMMISSION  
OF KENTUCKY  
EFFECTIVE

(N)

MAY 1 1993

PURSUANT TO 807 KAR 5:011,  
SECTION 9(1)

BY: *George H. Baker*  
PUBLIC SERVICE COMMISSION MANAGER

Issued: March 25, 1993

Effective: May 1, 1993

*Robert E. Aigmon* for

President, Cincinnati, Ohio

Vice President - Regulatory Affairs

ACCESS SERVICE TARIFF  
PSCK No. 2

CINCINNATI BELL TELEPHONE COMPANY

1st Revised Page 20  
Cancels Original Page 20

EXPLANATION OF ABBREVIATIONS (Cont'd)

TG - Telegraph Grade  
TLP - Transmission Level Point  
TSP - Telecommunications Service Priority  
TSPS - Traffic Service Position System  
TV - Television  
USOC - Uniform Service Order Code  
VG - Voice Grade  
V & H - Vertical & Horizontal  
WA - Wideband Analog  
WATS - Wide Area Telecommunications Service(s)  
WD - Wideband Data  
O TLP - Zero Transmission Level Point

(M)

(M)

REFERENCE TO OTHER TARIFFS

Whenever reference is made in this tariff to other tariffs of the Telephone Company, the reference is to the tariffs in force as of the effective date of this tariff, and to amendments thereto and successive issues thereof.

REFERENCE TO PUBLICATIONS

The following publications are referenced in this tariff and may be obtained from Bell Communications Research, Inc., Distribution Storage Center, 60 New England Ave., Piscataway, N.J. 08854:

Technical Reference:

|           |                         |                          |
|-----------|-------------------------|--------------------------|
| PUB 41004 | Issued: October, 1973   | Available: October, 1973 |
| PUB 62310 | Issued: September, 1983 | Available: October, 1983 |

**PUBLIC SERVICE COMMISSION  
OF KENTUCKY  
EFFECTIVE**

OCT 26 1992

**PURSUANT TO 807 KAR 5:011,  
SECTION 9 (1)**

BY:   
PUBLIC SERVICE COMMISSION MANAGER

Certain regulations on this page formerly appeared on Page 19.

Issued: September 24, 1992

Effective: October 26, 1992

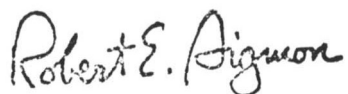
 for President, Cincinnati, Ohio

Vice President - Regulatory Affairs

ACCESS SERVICE TARIFF  
PSCK No. 2

CINCINNATI BELL TELEPHONE COMPANY

1st Revised Page 21  
Cancels Original Page 21

REFERENCE TO PUBLICATIONS (Cont'd)

Technical Reference: (Cont'd)

TR-NPL-000054 (Replaces PUB 62508)  
Issued: April, 1989 Available: May, 1989

TR-NPL-000334, Issue No. 1  
Issued: June, 1986 Available: July, 1986

TR-NPL-000335, Issue No. 1  
Issued: June, 1986 Available: July, 1986

TR-NPL-000336 (Replaces PUB 62502)  
Issued: September, 1986 Available: January, 1987

TR-NPL-000337 (Replaces PUB 62503)  
Issued: January, 1987 Available: January, 1987

TR-NPL-000338 (Replaces PUB 62504)  
Issued: January, 1987 Available: January, 1987

TR-NPL-000341 (Replaces PUB 62507)  
Issued: September, 1986 Available: January, 1987

TR-TSY-000342 (Replaces PUB 62508)  
Issued: January, 1987 Available: January, 1987

Special Report SR-EOP-000191, Issue No. 1  
Issued: April, 1985 Available: September, 1985

TR-NPL-000157, Issue No. 2  
Issued: April, 1986 Available: April, 1986

TR-TSV-000905, Issue No. 1  
Issued: August, 1989 Available: August, 1989

(N)  
(N)

**PUBLIC SERVICE COMMISSION  
OF KENTUCKY  
EFFECTIVE**

OCT 26 1992

**PURSUANT TO 807 KAH 5:011.  
SECTION 9 (1)**

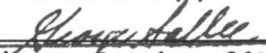
BY:   
Effective Date: **SEP 24 1992**

Issued: September 24, 1992

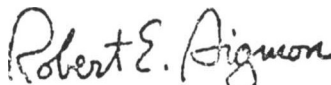
 for President, Cincinnati, Ohio

Vice President - Regulatory Affairs

ACCESS SERVICE TARIFF  
PSCK No. 2

CINCINNATI BELL TELEPHONE COMPANY

Original Page 22

REFERENCE TO PUBLICATIONS (Cont'd)

The following technical publication is referenced in this tariff and may be obtained from the Bell Communications Technical Education Center, Room B02, 6200 Route 53, Lisle, IL 60532.

Telecommunications Transmission Engineering  
Volume 3 - Networks and Services (Chapter 6 and 7)  
Second Edition, 1980  
Issued: June, 1980 Available: June, 1980

The following technical publication is referenced in this tariff and may be obtained from the National Exchange Carrier Association, Inc., Director - Tariff and Regulatory Matters, 100 So. Jefferson Road, Whippany, NJ 07981 and the Federal Communications Commission's commercial contractor.

PUB AS No. 1, Issue II  
Issued: May, 1984 Available: May, 1984

The following publication is referenced in this tariff and may be obtained from the Federal Communications Commission's commercial contractor.

National Exchange Carrier Association  
Tariff F.C.C. No. 4  
Issued: January, 1987 Available: January, 1987

The following publication, referenced in this tariff, is available for inspection in the Public Reference Room of the Tariff Division at the main building of the Federal Communications Commission located at 1919 M Street N.W., Washington, D.C., and may be obtained from the Commission's commercial contractor:

CC Docket No. 83-1145, Phase I  
Memorandum Opinion and Order  
(Including Appendices A, B, and C)  
Adopted: May 31, 1985 Released: June 12, 1985

PUBLIC SERVICE COMMISSION  
OF KENTUCKY  
EFFECTIVE

MAR 3 1992

PURSUANT TO 807 KAR 5:011,  
SECTION 9 (1)

BY: Shawn Deller  
PUBLIC SERVICE COMMISSION MANAGER

Effective: March 3, 1992

Issued: February 7, 1992

Robert E. Aigmon for  
President, Cincinnati, Ohio

Vice President - Regulatory Affairs

ACCESS SERVICE TARIFF  
PSC No. 2

CINCINNATI BELL TELEPHONE COMPANY

Original Page 23

1. Application of Tariff

- 1.1 This tariff contains regulations, rates and charges applicable to the provision of Carrier Common Line, End User Access, Switched Access and Special Access Services, and other miscellaneous services, hereinafter referred to collectively as service(s), provided by the Cincinnati Bell Telephone Company, hereinafter referred to as the Telephone Company, to customers.
- 1.2 The provision of such services by the Telephone Company as set forth in this tariff does not constitute a joint undertaking with the customer for the furnishing of any service.
- 1.3 The rate centers which comprise the operating territory of the Telephone Company are set forth in 15. following.

**PUBLIC SERVICE COMMISSION  
OF KENTUCKY  
EFFECTIVE**

MAR 3 1992

PURSUANT TO 807 KAR 5:011,  
SECTION 9 (1)

Effective: *March 3, 1992*  
PUBLIC SERVICE COMMISSION MANAGER

Issued: February 7, 1992

*Robert E. Aigmon*

for

President, Cincinnati, Ohio

**Vice President - Regulatory Affairs**

ACCESS SERVICE TARIFF  
PSC No. 2

CINCINNATI BELL TELEPHONE COMPANY

Original Page 24

2. General Regulations

2.1 Undertaking of the Telephone Company

2.1.1 Scope

- (A) The Telephone Company does not undertake to transmit messages under this tariff.
- (B) The Telephone Company shall be responsible only for the installation, operation, and maintenance of the services it provides.
- (C) The Telephone Company will, for maintenance purposes, test its services only to the extent necessary to detect and/or clear troubles.
- (D) Services are provided **24** hours daily, seven days per week, except as set forth in other applicable sections of this tariff.
- (E) The Telephone Company does not warrant that its facilities and services meet standards other than those set forth in this tariff.

**PUBLIC SERVICE COMMISSION  
OF KENTUCKY  
EFFECTIVE**

**MAR 3 1992**

**PURSUANT TO 807 KAR 5:011,  
SECTION 9(1)**

Issued: February 7, 1992

*Robert E. Aigmon* for

President, Cincinnati, Ohio

Effective: *March 3, 1992*  
PUBLIC SERVICE COMMISSION MANAGER

**Vice President - Regulatory Affairs**



ACCESS SERVICE TARIFF  
PSCK No. 2

CINCINNATI BELL TELEPHONE COMPANY

Original Page 25

2. General Regulations (Cont'd)

2.1 Undertaking of the Telephone Company (Cont'd)

2.1.2 Limitations

(A) The customer may not assign or transfer the use of services provided under this tariff; however, where there is no interruption of use or relocation of the services, such assignment or transfer may be made to:

- (1) another customer, whether an individual, partnership, association, or corporation, provided the assignee or transferee assumes all outstanding indebtedness for such services, and the unexpired portion of the minimum period and the termination liability applicable to such services, if any; or
- (2) a court-appointed receiver, trustee, or other person acting pursuant to law in bankruptcy, receivership, reorganization, insolvency, liquidation, or other similar proceedings, provided the assignee or transferee assumes the unexpired portion of the minimum period and the termination liability applicable to such services, if any.

In all cases of assignment or transfer, the written acknowledgment of the Telephone Company is required prior to such assignment or transfer which acknowledgment shall be made within 15 days from the receipt of notification. All regulations and conditions contained in this tariff shall apply to such assignee or transferee.

The assignment or transfer of services does not relieve or discharge the assignor or transferor from remaining jointly or severally liable with the assignee or transferee for any obligations existing at the time of the assignment or transfer.

(B) The regulations for the installation and restoration of Telecommunications Service Priority (TSP) System Services shall be subject to Part 64.401, Appendix A of the Federal Communications Commission's Rules and Regulations following.

PUBLIC SERVICE COMMISSION  
OF KENTUCKY  
EFFECTIVE

MAR 3 1992

PURSUANT TO 807 KAR 5:011.

Issued: February 7, 1992  
*Robert E. Aigmon* for

President, Cincinnati, Ohio

SECTION 9 (1)  
Effective: March 3, 1992  
BY: *Joseph J. Hall*  
PUBLIC SERVICE COMMISSION MANAGER

Vice President - Regulatory Affairs

2. General Regulations (Cont'd)

2.1 Undertaking of the Telephone Company (Cont'd)

2.1.2 Limitations (Cont'd)

- (C) Subject to compliance with the rules mentioned in (B) preceding, the services offered herein will be provided to customers on a first-come, first-served basis.

First-come first-served shall be based upon the received time and date stamped by the Telephone Company on complete and accurate customer orders which allow the Telephone Company to initiate its ordering process. The customer shall not be penalized for any delay in the Telephone Company review process beyond 1 working day of receipt. To the extent the order does not allow the Telephone Company to initiate the ordering process, the Telephone Company will attempt to complete the ordering process verbally with the customer. Once having been advised of the errors and/or omissions, any delay in correction on the part of the customer shall be added to the received time.

2.1.3 Liability

- (A) The Telephone Company's liability, if any, for its willful misconduct is not limited by this tariff. With respect to any other claim or suit, by a customer or by any others, for damages associated with the installation, provision, preemption, termination, maintenance, repair, or restoration of service, and subject to the provisions of (B) through (H) following, the Telephone Company's liability, if any, shall not exceed an amount equal to the proportionate charge for the service for the period during which the service was affected. This liability for damages shall be in addition to any amounts that may otherwise be due the customer under this tariff as a Credit Allowance for a Service Interruption.
- (B) The Telephone Company shall not be liable for any act or omission of any other carrier or customer providing a portion of a service, nor shall the Telephone Company for its own act or omission hold liable any other carrier or customer providing a portion of a service.

MAR 3 1992

PURSUANT TO 807 KAR 5:011,  
SECTION 9 (1)

Issued: February 7, 1992

Effective: *March 3, 1992*  
PUBLIC SERVICE COMMISSION MANAGER

*Robert E. Aigmon* FOR President, Cincinnati, Ohio

Vice President - Regulatory Affairs

ACCESS SERVICE TARIFF  
PSCK No. 2

CINCINNATI BELL TELEPHONE COMPANY

Original Page 27

2. General Regulations (Cont'd)

2.1 Undertaking of the Telephone Company (Cont'd)

2.1.3 Liability (Cont'd)

- (C) The Telephone Company is not liable for damages to the customer premises resulting from the furnishing of a service, including the installation and removal of equipment and associated wiring, unless the damage is caused by the Telephone Company's negligence.
- (D) The Telephone Company shall be indemnified, defended and held harmless by the end user against any claim, loss, or damage arising from the end user's use of services offered under this tariff, involving:
- (1) Claims for libel, slander, invasion of privacy, or infringement of copyright arising from the end user's own communications;
  - (2) Claims for patent infringement arising from the end user's acts combining or using the service furnished by the Telephone Company in connection with facilities or equipment furnished by the end user or IC or;
  - (3) All other claims arising out of any act or omission of the end user in the course of using services provided pursuant to this tariff.
- (E) The Telephone Company shall be indemnified, defended and held harmless by the IC against any claim, loss or damage arising from the IC's use of services offered under this tariff, involving:
- (1) Claims for libel, slander, invasion of privacy, or infringement of copyright arising from the IC's own communications;

PUBLIC SERVICE COMMISSION  
OF KENTUCKY  
EFFECTIVE

MAR 3 1992

PURSUANT TO 807 KAR 5:011.

SECTION 9 (1)

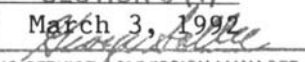
Effective: March 3, 1992  
BY:   
PUBLIC SERVICE COMMISSION MANAGER

Issued: February 7, 1992

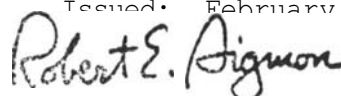
 for President, Cincinnati, Ohio

Vice President - Regulatory Affairs

ACCESS SERVICE TARIFF  
PSCK No. 2

CINCINNATI BELL TELEPHONE COMPANY

Original Page 28

2. General Regulations (Cont'd)

2.1 Undertaking of the Telephone Company (Cont'd)

2.1.3 Liability (Cont'd)

(E) (Cont'd)

(2) Claims for patent infringement arising from the IC's acts combining or using the service furnished by the Telephone Company in connection with facilities or equipment furnished by the end user or IC or;

(3) All other claims arising out of any act or omission of the IC in the course of using services provided pursuant to this tariff.

(F) The Telephone Company does not guarantee or make any warranty with respect to its services when used in an explosive atmosphere. The Telephone Company shall be indemnified, defended and held harmless by the customer from any and all claims by any person relating to such customer's use of services **so** provided.

(G) No license under patents (other than the limited license to use) is granted by the Telephone Company or shall be implied or arise by estoppel, with respect to any service offered under this tariff. The Telephone Company will defend the customer against claims of patent infringement arising solely from the use by the customer of services offered under this tariff and will indemnify such customer for any damages awarded based solely on such claims.

(H) The Telephone Company's failure to provide or maintain services under this tariff shall be excused by labor difficulties, governmental orders, civil commotions, criminal actions taken against the Telephone Company, acts of God, and other circumstances beyond the Telephone Company's reasonable control, subject to the Credit Allowance for a Service Interruption as set forth in 2.4.4 following.

PUBLIC SERVICE COMMISSION  
OF KENTUCKY  
EFFECTIVE

MAR 3 1992

PURSUANT TO 807 KAR 5:011.  
SECTION 9 (1)

Issued: February 7, 1992

Effective: March 3, 1992  
PUBLIC SERVICE COMMISSION MANAGER

*Robert E. Aigmon*

for

President, Cincinnati, Ohio

Vice President - Regulatory Affairs

ACCESS SERVICE TARIFF  
PSCK No. 2

CINCINNATI BELL TELEPHONE COMPANY

Original Page 29

2. General Regulations (Cont'd)

2.1 Undertaking of the Telephone Company (Cont'd)

2.1.4 Provision of Services

The Telephone Company, to the extent that such services are or can be made available with reasonable effort, and after provision has been made for the Telephone Company's Telephone Exchange Services, will provide to the customer upon reasonable notice services offered in other applicable sections of this tariff at rates and charges specified therein.

2.1.5 Installation and Termination of Services

The Access Services provided under this tariff (A) will include any entrance cable or drop wiring and wire or intrabuilding cable to that point where provision is made for termination of the Telephone Company's outside distribution network facilities at a suitable location inside a customer-designated premises and (B) will be installed by the Telephone Company to such Point of Termination. Access Service has only one Point of Termination per customer premises which may differ by types of service, e.g. Switched vs Special Access. Any additional terminations beyond such Point of Termination, except for embedded inside wire provided by the Telephone Company, is the sole responsibility of the customer. The Point of Termination is an inherent part of Switched and Special Access Services, therefore, the preceding does not preclude the customer's ability to have the Point of Termination moved as set forth in 6.7.7 and 7.4.5 following for Switched and Special Access Services, respectively.

2.1.6 Maintenance of Services

The services provided under this tariff shall be maintained by the Telephone Company. The customer or others may not rearrange, move, disconnect, remove or attempt to repair any facilities provided by the Telephone Company, other than by connection or disconnection to any interface means used, except with the written consent of the Telephone Company.

PUBLIC SERVICE COMMISSION  
OF KENTUCKY  
EFFECTIVE

MAR 3 1992

PURSUANT TO 807 KAR 5:011.

Issued: February 7, 1992

Effective: ~~SECTION 9~~ 11/1992

*Robert E. Aigmon*

for

President, Cincinnati, Ohio

BY: *Sharon Hella*  
PUBLIC SERVICE COMMISSION MANAGER

Vice President - Regulatory Affairs

2. General Regulations (Cont'd)

2.1 Undertaking of the Telephone Company (Cont'd)

2.1.7 Changes and Substitutions

Except as provided for equipment and systems subject to FCC Part **68** Regulations at 47 C.F.R. Section **68.110** (b), the Telephone Company may, where such action is reasonably required in the operation of its business, (A) substitute, change or rearrange any facilities used in providing service under this tariff, including but not limited to, (1) substitution of different metallic facilities, (2) substitution of carrier or derived facilities for wire facilities used to provide other than metallic services and (3) substitution of wire facilities for carrier or derived facilities used to provide other than metallic services, (B) change minimum protection criteria, (C) change operating or maintenance characteristics of facilities or (D) change operations or procedures of the Telephone Company. In case of any such substitution, change or rearrangement, the transmission parameters will be within the range as set forth in **6.** and **7.** following. The Telephone Company shall not be responsible if any such substitution, change or rearrangement renders any customer furnished services obsolete or requires modification or alteration thereof or otherwise affects their use or performance. If such substitution, change or rearrangement materially affects the operating characteristics of the facility, the Telephone Company will provide reasonable notification to the customer in writing. Reasonable time will be allowed for any redesign and implementation required by the change in operating characteristics. The Telephone Company will work cooperatively with the customer to determine reasonable notification requirements.

PUBLIC SERVICE COMMISSION  
OF KENTUCKY  
EFFECTIVE

MAR 3 1992

PURSUANT TO 807 KAR 5:011.  
SECTION 9 (1)

BY: Clayton Walker  
PUBLIC SERVICE COMMISSION MANAGER

Issued: February 7, 1992

Effective: March 3, 1992

Robert E. Aignone for

President, Cincinnati, Ohio

Vice President - Regulatory Affairs

2. General Regulations (Cont'd)

2.1 Undertaking of the Telephone Company (Cont'd)

2.1.8 Refusal and Discontinuance of Service

(A) Unless the provisions of 2.2.2(B) or 2.5 following apply, if a customer fails to comply with 2.1.6 preceding or 2.2.3, 2.3.1, 2.3.6, 2.3.7 or 2.4 following, including any payments to be made by it on the dates and times herein specified, the Telephone Company may, on thirty (30) days written notice by Certified U.S. Mail to the person designated by that customer to receive such notices of noncompliance, refuse additional applications for service and/or refuse to complete any pending orders for service by the noncomplying customer at any time thereafter. If the Telephone Company does not refuse additional applications for service on the date specified in the thirty (30) days notice, and the customer's noncompliance continues, nothing contained herein shall preclude the Telephone Company's right to refuse additional applications for service to the noncomplying customer without further notice.

(B) Unless the provisions of 2.2.2(B) or 2.5 following apply, if the customer fails to comply with 2.1.6 preceding or 2.2.3, 2.3.1, 2.3.6, 2.3.7 or 2.4 following, including any payments to be made by it on the dates and times herein specified, the Telephone Company may, on thirty (30) days written notice by Certified U.S. Mail to the person designated by the customer to receive such notices of noncompliance, discontinue the provision of the services to the noncomplying customer at any time thereafter. In the case of such discontinuance, all applicable charges, including termination charges, shall become due. If the Telephone Company does not discontinue the provision of the services involved on the date specified in the thirty (30) days notice, and the customer's noncompliance continues, nothing contained herein shall preclude the Telephone Company's right to discontinue the provision of the services to the noncomplying customer without further notice.

**PUBLIC SERVICE COMMISSION  
OF KENTUCKY  
EFFECTIVE**

MAR 3 1992

**PURSUANT TO 807 KAR 5:011,  
SECTION 9 (1)**

BY: Charles D. Miller  
PUBLIC SERVICE COMMISSION MANAGER  
Effective March 3, 1992

Issued: February 7, 1992

Robert E. Aizman

for

President, Cincinnati, Ohio

**Vice President - Regulatory Affairs**

ACCESS SERVICE TARIFF  
PSCK No. 2

CINCINNATI BELL TELEPHONE COMPANY

Original Page 32

2. General Regulations (Cont'd)

2.1 Undertaking of the Telephone Company (Cont'd)

2.1.9 Limitation of Use of Metallic Facilities

Signals applied to a metallic facility shall conform to the limitations set forth in Technical Reference Publication AS No. 1. In the case of application of dc telegraph signaling systems, the customer shall be responsible, at its expense, for the provision of current limiting devices to protect the Telephone Company facilities from excessive current due to abnormal conditions and for the provision of noise mitigation networks when required to reduce excessive noise.

2.1.10 Notification of Service-Affecting Activities

The Telephone Company will provide the customer reasonable notification of service-affecting activities that may occur in normal operation of its business. Such activities may include, but are not limited to, equipment or facilities additions, removals or rearrangements, routine preventative maintenance and major switching machine change-out. Generally, such activities are not individual customer service specific, they affect many customer services. No specific advance notification period is applicable to all service activities. The Telephone Company will work cooperatively with the customer to determine reasonable notification requirements.

2.1.11 coordination with Respect to Network Contingencies

The Telephone Company intends to work cooperatively with the customer to develop network contingency plans in order to maintain maximum network capability following natural or man-made disasters which affect telecommunications services.

PUBLIC SERVICE COMMISSION  
OF KENTUCKY  
EFFECTIVE

MAR 3 1992

PURSUANT TO 807 KAR 5:011,  
SECTION 9 (1)

BY: *Glenn Sallee*  
Effective March 3, 1992  
PUBLIC SERVICE COMMISSION MANAGER

Issued: February 7, 1992

*Robert E. Aigmon* for

President, Cincinnati, Ohio

Vice President - Regulatory Affairs



ACCESS SERVICE TARIFF  
PSCK No. 2

CINCINNATI BELL TELEPHONE COMPANY

Original Page 33

2. General Reaulations (Cont'd)

2.1 Undertaking of the Telephone Company (Cont'd)

2.1.12 Provision and Ownership of Telephone Numbers

The Telephone Company reserves the reasonable right to assign, designate or change telephone numbers, any other call number designations associated with Access Services, or the Telephone Company serving central office prefixes associated with such numbers, when necessary in the conduct of its business. Should it become necessary to make a change in such number(s), the Telephone Company will furnish to the customer 6 months notice, by Certified U.S. Mail, of the effective date and an explanation of the reason(s) for such change(s).

2.1.13 Provision of Title Directory Listings in Connection with FGA Services

Any listing provided in connection with FGA services will be subject to rates, charges and regulations for additional listings as found in the Telephone Company's local and/or general exchange service tariffs.

2.2 Use

2.2.1 Reserved

2.2.2 Interference or Impairment

(A) The characteristics and methods of operation of any circuits, facilities or equipment provided by other than the Telephone Company and associated with the facilities utilized to provide services under this tariff shall not interfere with or impair service over any facilities of the Telephone Company, its affiliated companies, or its connecting and concurring carriers involved in its services, cause damage to their plant, impair the privacy of any communications carried over their facilities or create hazards to the employees of any of them or the public.

PUBLIC SERVICE COMMISSION  
OF KENTUCKY  
EFFECTIVE

MAR 3 1992

PURSUANT TO 807 KAR 5:011,  
SECTION 9 (1)

BY: Cheryl J. Heller  
PUBLIC SERVICE COMMISSION MANAGER  
Effective: March 3, 1992

Issued: February 7, 1992

Robert E. Aigmon

for

President, Cincinnati, Ohio

Vice President - Regulatory Affairs

2. General Regulations (Cont'd)

2.2 Use (Cont'd)

2.2.2 Interference or Impairment (Cont'd)

(B) Except as provided for equipment or systems subject to the FCC Part 68 Rules in 47 C.F.R. Section 68.108, if such characteristics or methods of operation are not in accordance with (A) preceding, the Telephone Company will, where practicable, notify the customer that temporary discontinuance of the use of a service may be required; however, where prior notice is not practicable, nothing contained herein shall be deemed to preclude the Telephone Company's right to temporarily discontinue forthwith the use of a service if such action is reasonable under the circumstances. In case of such temporary discontinuance, the customer will be promptly notified and afforded the opportunity to correct the condition which gave rise to the temporary discontinuance. During such period of temporary discontinuance, credit allowance for service interruptions as set forth in 2.4.4 (A) and (B) following is not applicable.

2.2.3 Unlawful Use

The service provided under this tariff shall not be used for an unlawful purpose.

2.3 Obligations of the Customer

2.3.1 Damages

The customer shall reimburse the Telephone Company for damages to Telephone Company facilities utilized to provide services under this tariff caused by the negligence or willful act of the customer or resulting from the customer's improper use of the Telephone Company facilities, or due to malfunction of any facilities or equipment provided by other than the Telephone Company. Nothing in the foregoing provision shall be interpreted to hold one customer liable for another customer's actions. The Telephone Company will, upon reimbursement for damages, cooperate with the customer in prosecuting a claim against the person causing such damage and the customer shall be subrogated to the right of recovery by the Telephone Company for the damages to the extent of such payment.

PURSUANT TO 807 KAR 5:011,  
SECTION 9(1)

BY: Shayla Miller  
PUBLIC SERVICE COMMISSION MANAGER

Effective: March 3, 1992

Issued February 7, 1992  
Robert E. Aigmon for

President, Cincinnati, Ohio

Vice President - Regulatory Affairs

ACCESS SERVICE TARIFF  
PSC No. 2

CINCINNATI BELL TELEPHONE COMPANY

Original Page 35

2. General Reaulations (Cont'd)

2.3 Obliaations of the Customer (Cont'd)

2.3.2 Ownership of Facilities and Theft

Facilities utilized by the Telephone Company to provide service under the provisions of this tariff shall remain the property of the Telephone Company. Such facilities shall be returned to the Telephone Company by the customer, whenever requested, within a reasonable period following the request in as good condition as reasonable wear will permit.

2.3.3 Equipment Space and Power

The customer shall furnish or arrange to have furnished to the Telephone Company, at no charge, equipment space with suitable environmental characteristics and electrical power required by the Telephone Company to provide services under this tariff at the points of termination of such services. The selection of ac or dc power shall be mutually agreed to by the customer and the Telephone Company. The customer shall also make necessary arrangements in order that the Telephone Company will have access to such spaces at reasonable times for installing, testing, repairing or removing Telephone Company services.

2.3.4 Reserved

PUBLIC SERVICE COMMISSION  
OF KENTUCKY  
EFFECTIVE

MAR 3 1992

PURSUANT TO 807 KAR 5:011,

Effective: SECTION 9(1)  
March 3, 1992

BY: Sharon Keller  
PUBLIC SERVICE COMMISSION MANAGER

Issued: February 7, 1992

Robert E. Aigmon

for

President, Cincinnati, Ohio

Vice President - Regulatory Affairs

2. General Regulations (Cont'd)

2.3 Obligations of the Customer (Cont'd)

2.3.5 Reserved

2.3.6 Availability for Testing

The services provided under this tariff shall be available to the Telephone Company at times mutually agreed upon in order to permit the Telephone Company to make tests and adjustments appropriate for maintaining the services in satisfactory operating condition. Such tests and adjustments shall be completed within a reasonable time. No credit will be allowed for any interruptions involved during such tests and adjustments.

2.3.7 Balance

All signals for transmission over the services provided under this tariff shall be delivered by the customer balanced to ground except for ground start, duplex (DX) and McCulloh-Loop (Alarm System) type signaling and dc telegraph transmission at speeds of 75 baud or less.

2.3.8 Design of Customer Services

Subject to the provisions of 2.1.7 preceding, the customer shall be solely responsible, at its own expense, for the overall design of its services and for any redesigning or rearrangement of its services which may be required because of changes in facilities, operations or procedures of the Telephone Company, minimum protection criteria or operating or maintenance characteristics of the facilities.

PUBLIC SERVICE COMMISSION  
OF KENTUCKY  
EFFECTIVE

MAR 3 1992

PURSUANT TO 807 KAR 5:011,  
SECTION 9 (1)

By:   
Effective: March 3, 1992  
PUBLIC SERVICE COMMISSION MANAGER

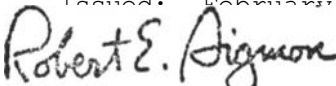
Issued: February 7, 1992  
 for  
President, Cincinnati, Ohio

Vice President - Regulatory Affairs

ACCESS SERVICE TARIFF  
PSCK No. 2

CINCINNATI BELL TELEPHONE COMPANY

Original Page 37

2. General Regulations (Cont'd)

2.3 Obligations of the Customer (Cont'd)

2.3.9 References to the Telephone Company

The customer may advise End Users that certain services are provided by the Telephone Company in connection with the service the customer furnishes to End Users; however, the customer shall not represent that the Telephone Company jointly participates in the customer's services.

2.3.10 Reserved

2.3.11 Claims and Demands for Damages

- (A) With respect to claims of patent infringement made by third persons, the customer shall defend, indemnify, protect and save harmless the Telephone Company from and against all claims arising out of the combining with, or use in connection with, the services provided under this tariff, any circuit, apparatus, system or method provided by the customer.
- (B) The customer shall defend, indemnify and save harmless the Telephone Company from and against any suits, claims, losses or damages, including punitive damages, attorney fees and court costs by third persons arising out of the construction, installation, operation, maintenance, or removal of the customer's circuits, facilities, or equipment connected to the Telephone Company's services provided under this tariff, including, without limitation, Workmen's Compensation claims, actions for infringement of copyright and/or unauthorized use of program material, libel and slander actions based on the content of communications transmitted over the customer's circuits, facilities or equipment, and proceedings to recover taxes, fines, or penalties for failure of the customer to obtain or maintain in effect any necessary certificates,

PUBLIC SERVICE COMMISSION  
OF KENTUCKY  
EFFECTIVE

MAR 3 1992

PURSUANT TO 807 KAR 5:011,  
SECTION 9 (1)

BY: *[Signature]*  
Effective March 3, 1992

Issued: February 7, 1992

*Robert E. Aiguon* for President, Cincinnati, Ohio

Vice President - Regulatory Affairs

ACCESS SERVICE TARIFF  
PSCK No. 2

CINCINNATI BELL TELEPHONE COMPANY

Original Page 38

2. General Regulations (Cont'd)

2.3 Obligations of the Customer (Cont'd)

2.3.11 Claims and Demands for Damages (Cont'd)

(B) (Cont'd)

permits, licenses, or other authority to acquire or operate the services provided under this tariff; provided, however, the foregoing indemnification shall not apply to suits, claims, and demands to recover damages for damage to property, death, or personal injury unless such suits, claims, or demands are based on the tortious conduct of the customer, its officers, agents or employees.

(C) The customer shall defend, indemnify and save harmless the Telephone Company from and against any suits, claims, losses or damages, including punitive damages, attorney fees and court costs by the customer or third parties arising out of any act or omission of the customer in the course of using services provided under this tariff.

2.3.12 Reserved

PUBLIC SERVICE COMMISSION  
OF KENTUCKY  
EFFECTIVE

MAR 3 1992

PURSUANT TO 807 KAR 5:011,  
SECTION 9 (1)

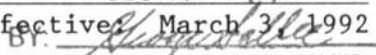
Effective March 3, 1992  
By:   
PUBLIC SERVICE COMMISSION MANAGER

Issued: February 7, 1992

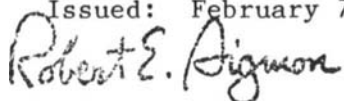
 for  
President, Cincinnati, Ohio

Vice President - Regulatory Affairs

ACCESS SERVICE TARIFF  
PSCK No. 2

CINCINNATI BELL TELEPHONE COMPANY

PUBLIC SERVICE COMMISSION  
1st Revised Page 39  
Cancels Original Page 39  
EFFECTIVE

2. General Regulations (Cont'd)

2.3 Obligations of the Customer (Cont'd)

2.3.13 Coordination with Respect to Network Contingencies

The customer shall, in cooperation with the Telephone Company, coordinate in planning the actions to be taken to maintain maximum network capability following natural or man-made disasters which affect telecommunications services.

2.3.14 Jurisdictional Report Requirements

(A) Jurisdictional Reports

- (1) (a) When a customer orders Feature Group A (FGA) and/or Feature Group B (FGB) Switched Access Service, the customer shall state, in its order, the portion of the service which is to be provided for interstate use. This portion is the Percent for Interstate Use or PIU. The customer can either specify one general projected PIU for the total FGA usage and one general projected PIU for the total FGB usage or the customer can specify an 800 terminating PIU and a residual PIU for each FGA and/or FGB Switched Access group ordered. If the customer chooses to provide a separate 800 terminating PIU, then they must provide one projected PIU for 800 terminating FGA and/or FGB group and one projected PIU (the residual PIU) for all the remaining FGA and/or FGB group usage. All PIUs shall be stated as whole number percentages (a number of 0 through 100).

- (b) Pursuant to Federal Communications Commission order FCC 85-145 adopted April 16, 1985 interstate usage is to be developed as though every call that enters a customer network at a point within the same state as that in which the called station (as designated by the called station number) is situated is an intrastate communication and every call for which the point of entry is in a state other than that where the called station (as designated by the called station number) is situated is an interstate communication.

Certain regulations previously found on this page are now found on page 40.

Issued: June 13, 1995

Effective: May 23, 1995

*Deborah A. Nisch*

President, Cincinnati, Ohio

Vice President  
Integrated Corporate Planning for

ACCESS SERVICE TARIFF  
PSCK No. 2

CINCINNATI BELL TELEPHONE COMPANY

1st Revised Page 40  
Cancels Original Page 40

2. General Regulations (Cont'd)

PUBLIC SERVICE COMMISSION  
OF KENTUCKY  
EFFECTIVE

2.3 Obligations of the Customer (Cont'd)

2.3.14 Jurisdictional Report Requirements (Cont'd)

MAY 23 1995

(A) Jurisdictional Reports (Cont'd)

PURSUANT TO KAR 501

(c) The projected PIUs will be used by the Telephone Company to apportion the total usage between interstate and intrastate until a revised report is received as set forth in (8) following.

(M)  
|  
(M)

- (2) All Feature Group A and B Switched Access Service usage and charges will be apportioned by the Telephone Company between interstate and intrastate. The projected PIU reported as set forth in (1) preceding will be used to make the apportionment.
- (3) For Feature Group A and B, the number of measured access minutes for a group will be multiplied by the projected PIU, as determined in (1) preceding, to develop the interstate access minutes. The number of access minutes for the group minus the developed interstate access minutes for the group will be the developed intrastate access minutes.

(4) When a customer orders Feature Group D (FGD), 800 Access Service and/or 900 Access Service, the customer shall, in its order, state the proportion of the service which is to be provided for interstate use. The customer has the option to state their proportion of interstate use separately for the usage types 800 originating, 800 terminating and/or 900 originating or the customer can designate one general Percentage for Interstate Use (PIU) for all FGC or GGD usage types. If the customer specifies a unique PIU for 800 originating, 800 terminating, and/or 900 originating traffic, then the customer must also provide a separate residual PIU that represents the percent of interstate use for all usage types for which a separate PIU has not been provided for each end office. All PIUs shall be stated as whole number percentages (a number of 0 through 100), for each end office to which the new FGC or FGD service is being ordered. The Telephone Company will designate the number, obtained by subtracting the PIU for originating and terminating access minutes from 100, as the interstate percentage of use ( $100 - \text{PIU} = \text{intrastate percentage}$ ).

(C)  
|  
(C)

Certain regulations found on this page previously appeared on Page 39.

Issued: June 13, 1995

Effective: May 23, 1995

*Deborah A. Nisch*

President, Cincinnati, Ohio

Vice President  
Integrated Corporate Planning for



ACCESS SERVICE TARIFF  
PSCK No. 2

CINCINNATI BELL TELEPHONE COMPANY

1st Revised Page 41  
Cancels Original Page 41

PUBLIC SERVICE COMMISSION  
OF KENTUCKY  
EFFECTIVE

2. ~~General Regulations~~ (Cont'd)

2.3 Oblinations of the Customer (Cont'd)

2.3.14 Jurisdictional Report Reauirements (Cont'd)

(A) Jurisdictional Reports (Cont'd)

(4) (Cont'd)

When a customer designates either one general PIU or separate PIUs for each usage type, the PIU should not include any originating usage types for which the Telephone Company is able to derive jurisdiction from call detail recording.

For originating access minutes that can be measured by the Telephone Company, the PIU will be developed on a monthly basis by end office by dividing the measured interstate originating access minutes (the access minutes where the calling number is in one state and the called number is in another state) by the total originating access minutes.

For terminating access minutes, the data used by the Telephone Company to develop the PIU for originating access minutes rill be used as the PIU for terminating access minutes.

- (5) Entrance Facilities and Direct-Trunked Transport Facilities rill be made available on December 30, 1993 in conformance with the restructure of Local Transport. Expanded Interconnection and Collocation Services will be made available for Switched Transport Services on February 15, 1994. Switched Access customers must provide a new PIU factors that reflect all Sritched Access services using these facilities as set forth in (a) through (c) following.

- (a) The customer may provide a PIU factor for each Entrance Facility or Electronic Cross-Connect and a separate PIU factor for each Direct-Trunked Transport facility. These PIU factors rill account for both the originating and terminating traffic of all switched Access services using these facilities.

MAY 23 1995

PURSUANT TO 807 KAR 5011,  
SECTION 9(1)

BY: *[Signature]*  
FOR THE PUBLIC SERVICE COMMISSION

(C)

(C)

Issued: June 13, 1995

Effective: May 23, 1995

President, Cincinnati, Ohio

*Deborah A. Nisch*

Vice President  
Integrated Corporate Planning for

ACCESS SERVICE TARIFF  
PSCK No. 2

CINCINNATI BELL TELEPHONE COMPANY

1st Revised Page 42  
Cancels Original Page 42

2. General Regulations (Cont'd)

2.3 Obligations of the Customer (Cont'd)

2.3.14 Jurisdictional Report Requirements (Cont'd)

(A) Jurisdictional Reports (Cont'd)

(5) (Cont'd)

(b) At the customer's option, a LATA-level PIU factor may be provided for all Entrance Facilities or Electronic Cross-Connect and for all Direct-Trunked Transport Facilities provided in the LATA. These PIU factors will account for both the originating and terminating traffic of all Switched Access services using these facilities switching the LATA. The specified percentage will be applied to all Entrance Facilities or Electronic Cross-Connect and to all Direct-Trunked Transport Facilities within the LATA.

(c) If the customer does not provide a PIU factor for an Entrance Facility, Electronic Cross-connect, or Direct-Trunked Transport Facility as set forth in (a) or (b) above, the Telephone Company will designate a PIU factor of 70%.

(6) When a customer orders ELI Service or Directory Assistance Service, the customer shall in its order, provide the projected PIU for terminating use in a whole number (a number of 0 through 100) for ELI Service or each Directory Access Service group ordered. The Telephone Company will designate the number obtained by subtracting the projected PIU furnished by the customer from 100 as the projected intrastate percentage of use (100 - customer percentage = intrastate percentage).

(C)

(C)

MAY 23 1995

PURSUANT TO 807 KAR 5.011,  
SECTION 9(1)

BY: Jonathan C. Neal  
FOR THE PUBLIC SERVICE COMMISSION

Issued: June 13, 1995

Effective: **May 23, 1995**

*Deborah A. Nisch* President, Cincinnati, Ohio  
Vice President  
Integrated Corporate Planning for

ACCESS SWVICE TARIFF  
PSCK No. 2

CINCINNATI BELL TELEPHONE COMPANY

1st Revised Page 43  
Cancels Original Page 43  
PUBLIC SERVICE COMMISSION  
OF KENTUCKY  
EFFECTIVE

2. General Regulations (Cont'd)

2.3 Oblinations of the Customer (Cont'd)

MAY 23 1995

2.3.14 Jurisdictional Report Requirements (Cont'd)

PURSUANT TO 807 KAR 5:011  
SECTION 19(1)

(A) Jurisdictional Reports (Cont'd)

- (7) Except where Telephone Company measured access minutes are used as set forth in (4) preceding, the customer reported PIU of use as set forth in (1), (4), (5), or (6) preceding will be used until the customer reports a different projected PIU. When the customer adds BEMC, lines or trunks to an existing service, the customer shall furnish, at the time the order is placed, a projected PIU that applies to the new group or usage type. When the customer discontinues BEMC, lines or trunks from an existing service, the customer shall furnish a projected PIU for the remaining group or usage type. The revised report will serve as the basis for future billing and will be effective on the next bill date. No prorating or back billing will be done based on the report.
- (8) Effective on the first of January, April, July and October of each year the customer shall update the jurisdictional report. The customer shall forward to the Telephone Company, to be received no later than 30 days after the first of each such month, a revised report showing the PIU for the past three months ending the last day of December, March, June and September, respectively, for each service arranged for interstate use. The revised report will serve as the basis for the next three months billing and will be effective on the bill date for that service. No prorating or back billing will be done based on the report. If the customer does not supply the reports, the Telephone Company will assume the percentages to be the same as those provided in the last quarterly report. For those cases in which a quarterly report has never been received from the customer, the Telephone Company will assume the percentages to be the same as those provided in the order for service as set forth in (1) preceding.

7/2/95  
SC-1  
(T)(M)  
M

Certain regulations found on this page previously appeared on Page 42.

Issued: June 13, 1995

Effective: May 23, 1995

President, Cincinnati, Ohio

*Deborah A. Ditch*

Vice President  
Integrated Corporate Planning for

ACCESS SERVICE TARIFF  
PSCK No. 2

CINCINNATI BELL TELEPHONE COMPANY

Original Page 44

2. General Regulations (Cont'd)

2.3 Obligations of the Customer (Cont'd)

2.3.14 Jurisdictional Revort Reauirements (Cont'd)

(B) Jurisdictional Revort Verification

If a billing dispute arises or a regulatory commission questions the projected interstate percentage, the Telephone Company will ask the customer to provide the data the customer uses to determine the projected interstate percentage. The customer shall keep sufficient detail from which the percentage of interstate use can be ascertained and upon request of the Telephone Company make the records available for inspection. Such request will be initiated by the Telephone Company no more than once per year. The customer shall supply the data within 30 days of the Telephone Company request.

2.3.15 Determination of Intrastate Charges for Mixed Interstate and Intrastate Access Service

When mixed interstate and intrastate Access Service is provided, all charges (i.e., nonrecurring, monthly and/or usage) including optional features charges, will be prorated between interstate and intrastate. The percentage provided in the reports as set forth in 2.3.14 (A) preceding will serve as the basis for prorating the charges. The percentage of an Access Service to be charged as intrastate is applied in the following manner.

- (A) For monthly and nonrecurring chargeable rate elements, multiply the percent interstate use times the quantity of chargeable elements times the stated tariff rate per element.

PUBLIC SERVICE COMMISSION  
OF KENTUCKY  
EFFECTIVE

MAR 3 1992

PURSUANT TO 807 KAR 5:011,  
SECTION 9 (1)

BY: Sharon Helle  
PUBLIC SERVICE COMMISSION MANAGER  
Effective: March 3, 1992

Issued February 7, 1992  
Robert E. Sigmon for

President, Cincinnati, Ohio

Vice President - Regulatory Affairs

2. General Regulations (Cont'd)

2.3 Obligations of the Customer (Cont'd)

2.3.15 Determination of Intrastate Charges for Mixed Interstate and Intrastate Access Service (Cont'd)

- (B) For usage sensitive (i.e., access minutes and calls) chargeable rate elements, multiply the percent intrastate use times actual use (i.e., measured or Telephone Company assumed average use) times the stated tariff rate.

The intrastate percentage will change as revised usage reports are submitted as set forth in 2.3.14 preceding.

2.3.16 Certification of Special Access Services As Intrastate

(A) Intrastate Classification Requirement

Pursuant to Federal Communications Commission Order FCC 89-224 adopted June 29, 1989 and released July 20, 1989, Special Access Services are to be classified as intrastate when the intrastate traffic amounts to or is greater than ten percent (10%) of the total traffic on a Special Access Service. Anything less than ten percent (10%) is considered intrastate.

(B) Certification Requirement

- (1) When a customer orders a Special Access Service from this tariff the customer shall certify, by its order that the Special Access Service carries intrastate traffic and the intrastate traffic is more than ten percent (10%) of the total traffic carried on the Special Access Service.
- (2) The customer shall notify the Telephone Company, by its order, when the amount of intrastate traffic carried by an existing Special Access Service line changes to the extent that the amount of intrastate traffic would be 10% or less of the total traffic carried by the service line. Upon such notification by the customer the Telephone Company will change the service line to that of the appropriate interstate tariff.

MAR 3 1992

PURSUANT TO 807 KAR 5:011,

Issued: February 7, 1992

Effective: SECTION 9 (1)  
March 3, 1992  
BY: *George Bell*  
PUBLIC SERVICE COMMISSION MANAGER

*Robert E. Aigmon* for  
President, Cincinnati, Ohio

Vice President - Regulatory Affairs

ACCESS SERVICE TARIFF  
PSCK No. 2

CINCINNATI BELL TELEPHONE COMPANY

Original Page 46

2. General Regulations (Cont'd)

2.4 Payment Arrangements and Credit Allowances

2.4.1 Payment of Rates, Charges and Deposits

(A) The Telephone Company will, in order to safeguard its interests, require a customer which has a proven history of late payments to the Telephone Company or does not have established credit, to make a deposit (prior to or at any time after the provision of a service to the customer) to be held by the Telephone Company as a guarantee of the payment of rates and charges. No such deposit will be required of a customer which is a successor of a company which has established credit and has no history of late payments to the Telephone Company. Such deposit may not exceed the actual or estimated rates and charges for the service for a two month period. The fact that a deposit has been made in no way relieves the customer from complying with the Telephone Company's regulations as to the prompt payment of bills. At such time as the provision of the service to the customer is terminated, the amount of the deposit will be credited to the customer's account and any credit balance which may remain will be refunded.

Such a deposit may be refunded or credited the account when the customer has established credit or, in any event, after the customer has established a one-year prompt payment record at any time prior to the termination of the provision of the service to the customer. In case of a cash deposit, for the period the deposit is held by the Telephone Company, the customer will receive interest at the same percentage rate as that set forth in (B)(3)(b)(I) or in (B)(3)(b)(II), whichever is lower. The calculation will be based on the number of days from the date the customer deposit is received by the Telephone Company to and including the date such deposit is credited to the customer's account or the date the deposit is refunded by the Telephone Company. Should a deposit be credited to the customer's account, as indicated above, no interest will be credited on the deposit from the date such deposit is credited to the customer's account.

PUBLIC SERVICE COMMISSION  
OF OHIO  
EFFECTIVE

MAR 3 1992

PURSUANT TO 807 KAR 5:011,  
SECTION 9 (1)

Issued: February 7, 1992  
*Robert E. Aigmon* for

President, Cincinnati, Ohio

BY: *[Signature]*  
Effective: March 3, 1992  
PUBLIC SERVICE COMMISSION MANAGER

Vice President - Regulatory Affairs

ACCESS SERVICE TARIFF  
PSC No. 2

CINCINNATI BELL TELEPHONE COMPANY

Original Page 47

2. General Regulations (Cont'd)

2.4 Payment Arrangements and Credit Allowances (Cont'd)

2.4.1 Payment of Rates, Charges and Deposits (Cont'd)

(B) The Telephone Company shall bill on a current basis all charges incurred by and credits due to the customer under this tariff attributable to services, including, but not limited to, Maintenance of Service as set forth in 13.3.1 following, established or discontinued during the preceding billing period. In addition, the Telephone Company shall bill in advance charges for all services to be provided during the ensuing billing period except for charges associated with service usage and for the Federal Government which will be billed in arrears. The bill day (i.e., the billing date of a bill for a customer for Access Service under this tariff), the period of service each bill covers and the payment date will be as follows:

- (1) For End User Access Service the Telephone Company will establish a bill day each month for each end user account. The bill will cover End User Access Service charges for the ensuing billing period except for End User Access Service for the Federal Government which will be billed in arrears. Any known unbilled charges for prior periods and any known unbilled adjustments for prior periods for End User Access Service and will be applied to this bill. Such bills are due when rendered.
- (2) For Service other than End User Access Service the Telephone Company will establish a bill day each month for each customer account. The bill will cover

PUBLIC SERVICE COMMISSION  
OF KENTUCKY  
EFFECTIVE

MAR 3 1992

PURSUANT TO 807 KAR 5:011,  
SECTION 9 (1)

BY: Cheryl L. Mays  
EFFECTIVE DATE: March 3, 1992

Issued: February 7, 1992

Robert E. Aignone for

President, Cincinnati, Ohio

**Vice President - Regulatory Affairs**

2. General Regulations (Cont'd)

2.4 Payment Arrangements and Credit Allowances (Cont'd)

2.4.1 Payment of Rates, Charges and Deposits (Cont'd)

(B) (Cont'd)

(2) (Cont'd)

nonusage sensitive service charges for the ensuring billing period for which the bill is rendered, any known unbilled nonusage sensitive charges for prior periods and unbilled usage charges for the period after the last bill day through the current bill day. Any known unbilled usage charges for prior periods and any known unbilled adjustments will be applied to this bill. Payment for such bills is due as set forth in (3) following. If payment is not received by the payment date, as set forth in (3) following in immediately available funds, a late payment penalty will apply as set forth in (3) following.

- (3) (a) All bills dated as set forth in (2) preceding for service provided to the customer by the Telephone Company are due 31 days (payment date) after the bill day or by the next bill date (i.e., same date in the following month as the bill date), whichever is the shortest interval, except as provided herein, and are payable in immediately available funds. If such payment date would cause payment to be due on a Saturday, Sunday, Holiday (i.e., New Year's Day, Independence Day, Labor Day, Thanksgiving Day, Christmas Day and a day when Washington's Birthday, Memorial Day or Columbus Day is legally observed), a day when the United States Postal Service does not deliver first class mail and/or commercial banks are closed or the first Tuesday after the first Monday in November, payment for such bills will be due from the customer as follows:

PUBLIC SERVICE COMMISSION  
OF KENTUCKY  
EFFECTIVE

MAR 3 1992

PURSUANT TO 807 KAR 5:011.  
SECTION 9 (1)

Issued: February 7, 1992

Effective March 3, 1992  
PUBLIC SERVICE COMMISSION MANAGER

*Robert E. Aigmon* for President, Cincinnati, Ohio

**Vice President - Regulatory Affairs**



General Regulations (Cont'd)

2.4 Payment Arrangements and Credit Allowances (Cont'd)

2.4.1 Payment of Rates, Charges and Deposits (Cont'd)

(B) (Cont'd)

(3) (a) (Cont'd)

If such payment date falls on a Sunday or on a Holiday which is observed on a Monday, the payment date shall be the first non-Holiday day following such Sunday or Holiday. If such payment date falls on a Saturday or on a Holiday which is observed on Tuesday, Wednesday, Thursday or Friday, the payment date shall be the last non-Holiday day preceding such Saturday or Holiday.

(b) Further, if any portion of the payment is received by the Telephone Company after the payment date as set forth in (a) preceding, or if any portion of the payment is received by the Telephone Company in funds which are not immediately available to the Telephone Company, then a late payment penalty shall be due to the Telephone Company. The late payment penalty shall be computed based upon the portion of the payment not received by the payment date times a late factor. The later factor shall be the lesser of:

(I) the highest interest rate (in decimal value) which may be levied by law for commercial transactions, compounded daily for the number of days from the payment date to and including the date that the customer actually makes the payment to the Telephone Company, or

(II) 0.000370 per day, simple interest for the number of days from the payment date to and including the date that the customer actually makes the payment to the Telephone Company. (C)

ACCESS SERVICE TARIFF  
PSC No. 2

CINCINNATI BELL TELEPHONE COMPANY

Original Page 50

2. General Regulations (Cont'd)

2.4 Payment Arrangements and Credit Allowances (Cont'd)

2.4.1 Payment of Rates, Charges and Deposits (Cont'd)

(B) (Cont'd)

- (3) (c) In the event that a billing dispute concerning any charges billed to the customer by the Telephone Company is resolved in favor of the Telephone Company, any payments withheld pending settlement of the dispute shall be subject to the late payment penalty set forth in (b) preceding.

If the customer disputes the bill on or before the payment date, and pays the undisputed amount on or before the payment date, any late payment charge for the disputed amount will not start until 10 working days after the payment date. If the billing dispute is resolved in favor of the customer, no late payment penalty will apply to the disputed amount.

If the customer disputes the billed amount on or before the payment date or within 90 days of payment and pays the total amount (i.e., the undisputed amount and the disputed amount) on or before the payment date and the billing dispute is resolved in favor of the customer, the customer will receive a credit to its bill or a wire transfer of monies for the disputed amount. In addition, a penalty amount shall be paid to the customer. The penalty amount shall be the disputed amount resolved in the customer's favor times a penalty factor. The penalty factor will be calculated from the date the customer paid the total amount (i.e., the undisputed amount and the disputed amount) to the date the dispute is resolved.

PUBLIC SERVICE COMMISSION  
OF KENTUCKY  
EFFECTIVE

MAR 3 1992

PURSUANT TO 807 KAR 5:011  
EFFECTIVE SECTION 13, 1992

BY: Sharon L. Latta  
PUBLIC SERVICE COMMISSION MANAGER

Issued: February 7, 1992

Robert E. Aigmon

for

President, Cincinnati, Ohio

Vice President - Regulatory Affairs

ACCESS SERVICE TARIFF  
PSCK No. 2

CINCINNATI BELL TELEPHONE COMPANY

Original Page 51

2. General Reaulations (Cont'd)

2.4 Payment Arrangements and Credit Allowances (Cont'd)

2.4.1 Payment of Rates, Charges and Deposits (Cont'd)

(B) (Cont'd)

(3) (c) (Cont'd)

If the customer disputes the billed amount after 90 days of payment and paid the total amount (i.e., the nondisputed amount and the disputed amount) on or before the payment date and the billing dispute is resolved in favor of the customer, the customer will receive a credit to its bill or wire transfer of monies for the disputed amount. In addition, a penalty amount shall be paid to the customer. The penalty amount shall be the disputed amount resolved in the customer's favor times a penalty factor. The penalty factor will be calculated from the date the customer notifies the Telephone Company of the disputed amount either verbally or in writing and furnishes the Telephone Company the necessary documentation to support its claim to the date the dispute is resolved. If the documentation submitted does not support the claim, then the penalty factor will be calculated from the last date documentation was submitted that supports the claim up to the date the dispute is resolved.

The penalty factor shall be the lesser of:

- (I) the highest interest rate (in decimal value) which may be levied by law for commercial transactions, compounded daily for the number of days from the first date to and including the last date of the period involved, or
- (II) 0.000493 per day, simple interest for the number of days from the public service commission including the last date of the public service commission of Kentucky involved. EFFECTIVE

MAR 3 1992

Issued: February 7, 1992

PURSUANT TO 807 KAR 5:011,  
Effective March 3, 1992

*Robert E. Aignnon* for

President, Cincinnati, Ohio

BY: *Glenn Hallee*  
PUBLIC SERVICE COMMISSION MANAGER

Vice President - Regulatory Affairs

ACCESS SERVICE TARIFF  
PSC No. 1

CINCINNATI BELL TELEPHONE COMPANY

Original Page 52

2. General Regulations (Cont'd)

2.4 Payment Arrangements and Credit Allowances (Cont'd)

2.4.1 Payment of Rates, Charges and Deposits (Cont'd)

- (C) When a payment for Access Service charges billed under this tariff is due to the Telephone Company from the customer as set forth in (B)(3) preceding on the same payment date that a Purchase of Accounts Receivable net purchase amount is due to the customer from the Telephone Company as set forth in 8.2.3 following, the Telephone Company may, with at least 31 days notice to the customer, net the payment for customer Access Service Charges with the net purchase amount. The Telephone Company will pay the net amount to the customer on the payment date when such net amount is due to the customer or require the customer to pay to the Telephone Company the net amount when such net amount is due to the Telephone Company. If either party does not make the payment on the payment date, a late payment penalty as set forth in 8.2.3(C) following or (B)(3) preceding, whichever is appropriate, applies.

PUBLIC SERVICE COMMISSION  
OF KENTUCKY  
EFFECTIVE

MAR 3 1992

PURSUANT TO 807 KAR 5:011,

Effective: <sup>SECTION 9(1)</sup> March 3, 1992

BY: Cheryl H. Lee  
PUBLIC SERVICE COMMISSION MANAGER

Issued: February 7, 1992

Robert E. Aigmon for President, Cincinnati, Ohio

Vice President - Regulatory Affairs

ACCESS SERVICE TARIFF  
PSC No. 2

CINCINNATI BELL TELEPHONE COMPANY

Original Page 53

2. General Regulations (Cont'd)

2.4 Payment Arrangements and Credit-Allowances (Cont'd)

2.4.1 Payment of Rates, Charges and Deposits (Cont'd)

- (D) Adjustments for the quantities of services established or discontinued in any billing period beyond the minimum period set forth for services in other sections of this tariff will be prorated to the number of days or major fraction of days based on a **30** day month. The Telephone Company will, upon request and if available, furnish such detailed information as may reasonably be required for verification of any bill.
- (E) When a rate as set forth in this tariff is shown to more than two decimal places, the charges will be determined using the rate shown. The resulting amount will then be rounded to the nearest penny (i.e., rounded to two decimal places).
- (F) When more than one copy of a customer bill for services provided under the provisions of this tariff is furnished to the customer, an additional charge applies for each additional copy of the bill as set forth in **13.3.6** following.

PUBLIC SERVICE COMMISSION  
OF KENTUCKY  
EFFECTIVE

MAR 3 1992

Issued: February 7, 1992

*Robert E. Aigunon* for  
President, Cincinnati, Ohio

PURSUANT TO 807 KAR 5:011,  
Effective March 3, 1992  
BY: *Sharon Helle*  
PUBLIC SERVICE COMMISSION MANAGER

Vice President - Regulatory Affairs

ACCESS SERVICE TARIFF  
PSC No. 2

CINCINNATI BELL TELEPHONE COMPANY

1st Revised Page 54  
Cancels Original Page 54

2. General Regulations (Cont'd)

2.4 Payment Arrangements and Credit Allowances (Cont'd)

2.4.2 Minimum Periods

The minimum period for which services are provided and for which rates and charges are applicable is one month except for those services set forth in 5.2.5(C), 7.4.4, 7.4.9, 8.2.1(E)(2), 8.2.2.(E)(2), 8.3.5(A), 8.4.5(A), 9.4(A), 13.3.5(C)(1)(b), (c) and (d) following. The minimum period for which service is provided and for which rates and charges are applicable for a Specialized Service or Arrangement provided on an individual case basis as set forth in 12. following, is one month unless a different minimum period is established with the individual case filing. (T)

When a service is discontinued prior to the expiration of the minimum period, charges are applicable, whether the service is used or not, as follows:

- (A) When a service with a one month minimum period is discontinued prior to the expiration of the minimum period, a one month charge will apply at the rate level in effect at the time service is discontinued.
- (B) When a service with a minimum period greater than one month is discontinued prior to the expiration of the minimum period, the applicable charge will be the lesser of (1) the Telephone Company's total nonrecoverable costs less the net salvage value for the discontinued service or (2) the total monthly charges, at the rate level in effect at the time service is discontinued, for the remainder of the minimum period, unless otherwise specified under the terms of an Optional Payment Plan.

PUBLIC SERVICE COMMISSION  
OF KENTUCKY  
EFFECTIVE

MAY 23 1995

PURSUANT TO 807 KAR 5011,  
SECTION 9(1)  
BY:  Gordon C. Neal   
FOR THE PUBLIC SERVICE COMMISSION

Issued: June 13, 1995

Effective: May 23, 1995

*Deborah A. Nisch*  
Vice President  
Integrated Corporate Planning for Cincinnati, Ohio

2.4 Payment Arrangements and Credit Allowances (Cont'd)

2.4.3 Cancellation of an Order for Service

Provisions for the cancellation of an Access Order for Switched Access or Special Access are set forth in 5.2.2(B), 5.2.3 and 5.4.5 following.

2.4.4 Credit Allowance for Service Interruptions

(A) General

A service is interrupted when it becomes Unusable to the customer because of a failure of a facility component used to furnish service under this tariff or in the event that the protective controls applied by the Telephone Company result in the complete loss of service by the customer as set forth in 6.5.1 following. An interruption period starts when an inoperative service is reported to the Telephone Company, and ends when the service is operative.

(B) When a Credit Allowance Applies

In case of an interruption to any service, allowance for the period of interruption, if not due to the negligence of the customer, shall be as follows:

- (1) For Switched Transport Voice Grade Entrance Facilities, and Direct-Trunked Transport, and for Special Access Services other than Program Audio, Video Services, Digital Data, MercNET 1.5, MercNET 45, OC-3, OC-12, and OC-48 Services and Shared SONET Service, no credit shall be allowed for an interruption of less than thirty (30) minutes. The customer shall be credited for an interruption of 30 minutes or more at the rate of 1/1440 of the monthly charges for the facility or service for each period of 30 minutes or major fraction thereof that the interruption continues. (C)

The monthly charges used to determine the credit shall be as follows:

- (a) For two-point Special Access services, the monthly charge shall be the total of all the monthly rate element charges associated with the service.\*

\*(i.e., Channel Terminations, Channel Mileage, optional features and functions, and, when applicable surcharge for Special Access Service).

ACCESS SERVICE TARIFF  
PSCK No. 2

CINCINNATI BELL TELEPHONE COMPANY

1st Revised Page 56  
Cancel **Original** Page 56

2. General Regulations (Cont'd)

PUBLIC SERVICE COMMISSION  
OF KENTUCKY  
EFFECTIVE

2.4 Payment Arrangements and Credit Allowances (Cont'd)

2.4.4 Credit Allowance for Service Interruptions (Cont'd) MAY 23 1995

(B) When A Credit Allowance Applies (Cont'd) PURSUANT TO 807 KAR 5011.

(1) (Cont'd)

SECTION 011  
BY: *Jordan C. Hall*  
FOR THE PUBLIC SERVICE COMMISSION

(b) For multipoint **Special Access services**, (C)  
the monthly charge shall be the total of  
all monthly rate element charges associated  
with that portion of the service\* that is  
inoperative between the Hub and a customer  
premises.

(c) For multiplexed Special Access services, the (C)  
monthly charge shall be the total of all the  
monthly rate element charges associated with  
that portion of the service that is inopera-  
tive. When the facility which is multi-  
plexed or the multiplexer itself is  
inoperative, the monthly charge shall be the  
total of all the monthly rate element  
charges associated with the service\*. When  
the service which rides a channel of the  
multiplexed facility is inoperative, the  
monthly charge shall be the total of all the  
monthly rate element charges associated with  
that portion of the service\* from the Hub to  
a customer premises.

\*(i.e., Channel Termination(s), Channel  
Mileage optional features and functions,  
and, when applicable, surcharge for Special  
Access Service).

(d) For Switched Transport **Entrance Facilities** and **Direct-Trunked Transport**, the monthly charge shall be the total of all monthly rate element charges associated with the service. The rate elements include **Entrance Facilities** and **Direct-Trunked Transport Fixed and Per Mile Charges**. (N)

Issued: June 13, 1995

Effective: May 23, 1995

*Deborah H. Busch*  
Vice President

President, Cincinnati, Ohio

Integrated Corporate Planning for



ACCESS SERVICE TARIFF  
PSCK No. 2

CINCINNATI BELL TELEPHONE COMPANY

1st Revised Page 57  
Cancels Original Page 57

2. General Regulations (Cont'd)

PUBLIC SERVICE COMMISSION  
OF KENTUCKY  
EFFECTIVE

2.4 ~~Payment Arrangements and Credit Allowances~~ (Cont'd)

2.4.4 Credit Allowance for Service Interruptions (Cont'd)

(B) When A Credit Allowance Applies (Cont'd)

MAY 23 1995

PURSUANT TO 807 KAR 5.011,  
SECTION 9(1)

(1) (Cont'd)

the monthly charge shall be the ~~total of all~~ <sup>total of all</sup> the monthly rate element charges associated with that portion of the service that is inoperative. When the facility which is multiplexed or the multiplexer itself is inoperative, the monthly charge shall be the total of all monthly rate element charges associated with the service.\* When the service which rides a channel of the multiplexed facility is inoperative, the monthly charge shall be the total of all the monthly rate element charges associated with that portion of the service\* from the Hub to an end

(2) For Program Audio Special Access Services, no credit shall be allowed for an interruption of less than 30 seconds. The customer shall be credited for an interruption of 30 seconds or more as follows:

(a) For two-point services, when monthly rates are applicable, the credit shall be at the rate of 1/8640 of the monthly charge for the service\*\* for each period of 5 minutes or fraction thereof that the interruption continues.

(b) For two-point services, when daily rates are applicable, the credit shall be at the rate of 1/288 of the daily charges for the service\* for each period of 5 minutes or fraction thereof that the interruption continues.

\*\* (i.e., Channel Termination(s), Channel Mileage optional features and functions, and, when applicable, surcharge for Special Access Service).

\* (i.e., Entrance Facilities, Multiplexer(s), (N) and Direct-Trunked Transport, Fixed and (N) Per Mile Charges.)

Certain regulations previously found on this page now appear on Page 58.

Issued: June 13, 1995

Effective: May 23, 1995



President, Cincinnati, Ohio

Vice President  
Integrated Corporate Planning for

ACCESS SERVICE TARIFF  
PSCK No. 2

CINCINNATI BELL TELEPHONE COMPANY

1st Revised Page 58  
Cancels Original Page 58

2. General Regulations (Cont'd)

2.4 Payment Arrangements and Credit Allowances (Cont'd)

2.4.4 Credit Allowance for Service Interruptions (Cont'd)

(B) When A Credit Allowance Applies (Cont'd)

(2) (Cont'd)

- (c) For multipoint services, when monthly rates are applicable, the credit shall be at the rate of  $1/8640$  of the monthly charges for the service\* for each period of 5 minutes or fraction thereof that the interruption continues. (M)
- (d) For multipoint service, when daily rates are applicable, the credit shall be at the daily rate of  $1/288$  of the daily charges for the service\* for each period of 5 minutes or fraction thereof that the interruption continues. (M)
- (e) For multipoint services, the credit for the monthly or daily charges includes the charges for the distribution amplifier only when the distribution amplifier is inoperative.
- (f) When two or more interruptions occur during a period of 5 consecutive minutes, such multiple interruptions shall be considered as one interruption.

\*(i.e., channel Termination(s), Channel Mileage optional features and functions, and, when applicable, surcharge for Special Access Service). (M)

PUBLIC SERVICE COMMISSION  
OF KENTUCKY  
EFFECTIVE

MAY 23 1995

PURSUANT TO 807 KAR 5.011,  
SECTION 9 (1)

BY: Jordan C. Neal  
FOR THE PUBLIC SERVICE COMMISSION

Certain regulations on this page formerly appeared on Page 57.

Issued: June 13, 1995

Effective: May 23, 1995

*Deborah A. Nisch*

President, Cincinnati, Ohio

Vice President  
Integraed Corporate Planning for

2. General Regulations (Cont'd)

2.4 Payment Arrangements and Credit Allowances (Cont'd)

2.4.4 Credit Allowance for Service Interruptions (Cont'd)

(B) When A Credit Allowance Applies (Cont'd)

- (3) For Directory Assistance Service, no credit shall be allowed for an interruption of less than 24 hours. The customer shall be credited for an interruption of 24 hours or more at the rate of 1/30 of (a) the monthly rates.
- (4) The credit allowance(s) for an interruption or for a series of interruptions shall not exceed (a) the monthly rates. The allowable credit will be computed based upon the billing method which applies to the service being credited.
- (5) For certain Special Access services (Wideband Data, WDI-3; Digital Data Access, DA1-4; and High Capacity, HC1, OC-3, OC-12, and OC-48 Services, and Shared SONET Service). any period during which the error performance is below that specified for the service will be considered as an **interruption**. (C) (C)
- (6) Service interruptions for Specialized Service or Arrangements provided under the provisions of 10. or 12. following shall be administered in the same manner as those set forth in this section (2.4.4) unless other regulations are specified with the individual case **fiiling**.

General Regulations (Cont'd)

2.4 Payment Arrangements and Credit Allowances (Cont'd)

2.4.4 Credit Allowance for Service Interruptions (Cont'd)

(B) When a Credit Allowance Applies (Cont'd)

- (7) For Switched Transport Entrance Facilities and Direct Trunked Transport, other than Voice Grade, for any CCSAC Signaling Link Channel Terminations and Mileage (fixed and per mile), and for Digital Data, MercNET 1.5, MercNET 45, OC-3, OC-12 and OC-48 Special Access Services and Shared SONET Service, a credit allowance will be made for each occurrence of a service interruption period of (30) thirty or more consecutive minutes. The credit allowance rate can only be applied once on a per calendar month, per circuit basis. The credit allowance is applied to the customer bill in addition to the existing monthly service rates for Switched Transport Entrance Facilities and Direct Trunked Transport and for Digital Data, MercNet 1.5, MercNet 45 services and Shared SONET Service. The customer credit allowance is the monthly rate associated with the Switched Transport Entrance Facility and Direct Trunked Transport (fixed and per mile), and the CCSA signaling link channel terminations and mileage (fixed and per mile) charges in Section 6 of this tariff or the Special Access channel termination and mileage (fixed and per mile) charges and the Network Access Connection, Off-Network Access Connection and Service Area Transport charges in Section 7 of this tariff. (C)
- (8) When a Switched Access Direct Trunked facility, other than Voice Grade, experiences an interruption of service, a credit allowance will apply as described in 2.4.4(B)(7) preceding. However, when a customer who has both Direct Trunked and Access services to the same central office experiences a service interruption on the direct trunks, the customer will receive a credit based on the traffic that is diverted from the out-of-service facility to the tandem and charged at tandem rates. (N)
- The MOU credit will be derived by assuming 9000 MOU per trunk per month. Therefore, the daily credit would be limited to 300 MOU per trunk. (N)

Tandem

2. General Regulations (Cont'd)

2.4 Payment Arrangements and Credit Allowances (Cont'd)

2.4.4 Credit Allowance for Service Interruptions (Cont'd)

(c) When A Credit Allowance Does Not Apply

No credit allowance will be made for:

- (1) Interruptions caused by the negligence of the customer.
- (2) Interruptions of a service due to the failure of equipment or systems provided by the customer or others.
- (3) Interruptions of a service during any period in which the Telephone Company is not afforded access to the premises where the service is terminated.
- (4) Interruptions of a service when the customer has released that service to the Telephone Company for maintenance purposes, to make rearrangements, or for the implementation of an order for a change in the service during the time that was negotiated with the customer prior to the release of that service. Thereafter, a credit allowance as set forth in (B) preceding applies.
- (5) Interruptions of a service which continue because of the failure of the customer to authorize replacement of any element of special construction. The period for which no credit allowance is made begins on the seventh day after the customer receives the Telephone Company's written notification of the need for such replacement and ends on the day after receipt by the Telephone Company of the customer's written authorization for such replacement.

PUBLIC SERVICE COMMISSION  
OF KENTUCKY  
EFFECTIVE

MAR 3 1992

PURSUANT TO 807 KAR 5:011,  
SECTION 9 (1)

BY: *Sharon Hallee*  
PUBLIC SERVICE COMMISSION MANAGER

Issued: February 7, 1992

Effective: March 3, 1992

*Robert E. Aignon* for President, Cincinnati, Ohio

**Vice President - Regulatory Affairs**

ACCESS SERVICE TARIFF  
PSC No. 2

CINCINNATI BELL TELEPHONE COMPANY

1st Revised Page 61  
Cancels Original Page 61

2. General Regulations (Cont'd)

2.4 Payment Arrangements and Credit Allowances (Cont'd)

2.4.4 Credit Allowance for Service Interruptions (Cont'd)

(C) When A Credit Allowance Does Not Apply (Cont'd)

- (6) Periods when the customer elects not to release the service for testing and/or repair and continues to use it on an impaired basis.
- (7) Periods of temporary discontinuance as set forth in 2.2.2(B) preceding.
- (8) Periods of interruption as set forth in 13.3.1 following.
- (9) An interruption or a group of interruptions, resulting from a common cause, for amounts less than one dollar.

(D) Use of an Alternative Service Provided by the Telephone Company

Should the customer elect to use an alternative service provided by the Telephone Company during the period that a service is interrupted, the customer must pay the tariffed rates and charges for the alternative service used.

(E) Temporary Surrender of a Service

In certain instances, the customer may be requested by the Telephone Company to surrender a service for purposes other than maintenance, testing or activity relating to a service order. If the customer consents, a credit allowance will be granted. The credit allowance will be 1/1440 of the monthly rate for each period of 30 minutes or fraction thereof that the service is surrendered. In no case will the credit allowance exceed the monthly rate for the service surrendered in any one monthly billing period.

PUBLIC SERVICE COMPANY  
CINCINNATI  
EFFECTIVE

(S)

MAY 23 1995

PURSUANT TO 807 KAR 5011  
SECTION 9 (1)  
BY *[Signature]*

Issued: June 13, 1995

Effective: May 23,

*Deborah A. Nisch* President, Cincinnati, Ohio  
Vice President  
Integrated Corporate Planning for

2. General Regulations (Cont'd)

2.4 Payment Arrangements and Credit Allowances (Cont'd)

2.4.5 Service Installation Interval Guarantee

(N)

A failure to meet the installation interval service date for Digital Data service, MercNET 45 and MercNET 1.5 service (as specified in the Cincinnati Bell Telephone Due Date Interval Schedule), where the failure to meet the service installation date is solely the responsibility of the Telephone Company, will result in a customer credit listed below:

|                      | <u>Credit</u> |
|----------------------|---------------|
| Digital Data Service | (\$50.00)     |
| MercNET 1.5 Service  | (\$100.00)    |
| MercNET 45 Service   | (\$500.00)    |

This guarantee does not apply to any Digital Data service, MercNET 45 and MercNET 1.5 service installation involving circumstances beyond the control of the Telephone Company, such as:

- The customer changes interface requirements
- The customer requests expedited treatment
- The customer's premises is inaccessible
- The customer is not ready to accept service
- The customer orders termination beyond the Network Interface
- When the Telephone Company is not the Access Service Coordination Exchange Carrier (ASC-EC), as set forth in 2.4.8 (Billing of Access Service provided by Multiple Companies) following, and the Confirmed Due Date is not met by the exchange company acting as the ASC-EC for its position of the service. (See diagram on Page 61.2.)

(N)  
PUBLIC SERVICE COMMISSION  
OF KENTUCKY  
EFFECTIVE

MAY 23 1995

PURSUANT TO 807 KAR 5011,  
SECTION 9(1)  
BY: Jordan C. Neal  
FOR THE PUBLIC SERVICE COMMISSION

Issued: June 13, 1995

Effective: May 23, 1995

*Deborah A. Nisch*

President, Cincinnati, Ohio

Vice President

Integrated Corporate Planning for

ACCESS SERVICE TARIFF  
PSCK No. 2

CINCINNATI BELL TELEPHONE COMPANY

Original Page 61.2

2. General Regulations (Cont'd)

2.4 Payment Arrangements and Credit Allowances (Cont'd)

2.4.5 Service Installation Interval Guarantee (Cont'd)

(N)

|                               | CBT<br><u>ASC-EC</u> | Another<br><u>LEC ASC-EC</u>       |
|-------------------------------|----------------------|------------------------------------|
| CBT<br>Misses<br>Date         | Credit<br>applies    | Credit<br>applies                  |
| Another<br>LEC Hisses<br>Date | Credit<br>applies    | Credit<br>does not<br><b>apply</b> |

- Building facilities are not ready (such as space, cable support structures, building risers and entrance facilities to be provided by builder or owner or owner's subcontracted vendors
- If special construction is required
- During natural disasters or a declared national emergency (Priority Installation of Telecommunications Service Priority as described in 10.8.1 (D) will take precedence)

(N)

PUBLIC SERVICE COMMISSION  
OF KENTUCKY  
EFFECTIVE

MAY 23 1995

PURSUANT TO 807 KAR 5011,  
SECTION 9(1)

BY: *James H. Hoel*  
FOR THE PUBLIC SERVICE COMMISSION

Issued: June 13, 1995

Effective: May 23, 1995

*Deborah A. Nisch* President, Cincinnati, Ohio  
Vice President  
Integrated Corporate Planning for



2. General Regulations (Cont'd)

2.4 Payment Arrangements and Credit Allowances (Cont'd)

2.4.6 Reestablishment of Service Following Fire, Flood or Other Occurrence

(A) Nonrecurring Charges Do Not Apply

Charges do not apply for the reestablishment of service following a fire, flood or other occurrence attributed to an Act of God provided that:

- (1) The service is of the same type as was provided prior to the fire, flood or other occurrence.
- (2) The service is for the same customer.
- (3) The service is at the same location on the same premises.
- (4) The reestablishment of service begins within 60 days after Telephone Company service is available. (The 60 day period may be extended a reasonable period if the renovation of the original location on the premises affected is not practical within the allotted time period).

(B) Nonrecurring Charges Apply

Nonrecurring Charges apply for establishing service at a different location on the same premises or at a different premises pending reestablishment of service at the original location.

PUBLIC SERVICE COMMISSION  
OF KENTUCKY  
EFFECTIVE

MAR 3 1992

PURSUANT TO 807 KAR 5:011.

SECTION 9 (1)

Effective: March 3, 1992

BY: *Robert E. Aiguon*  
PUBLIC SERVICE COMMISSION MANAGER

Issued: February 7, 1992

*Robert E. Aiguon* for President, Cincinnati, Ohio

Vice President - Regulatory Affairs

ACCESS SERVICE TARIFF  
PSCK No. 2

CINCINNATI BELL TELEPHONE COMPANY

Original Page 63

2. General Regulations (Cont'd)

2.4 Payment Arrangements and Credit Allowances (Cont'd)

2.4.7 Title or Ownership Rights

The payment of rates and charges by customers for the service offered under the provisions of this tariff does not assign, confer, or transfer title or ownership rights to proposals or facilities developed or utilized, respectively, by the Telephone Company in the provision of such services.

2.4.8 Reserved

PUBLIC SERVICE COMMISSION  
OF KENTUCKY  
EFFECTIVE

MAR 3 1992

PURSUANT TO 807 KAR 5:011,  
SECTION 9 (1)

Issued: February 7, 1992

*Robert E. Aigmon*

President, Cincinnati, Ohio

*Blair*  
Effective: *March 3, 1992*  
PUBLIC SERVICE COMMISSION MANAGER

**Vice President - Regulatory Affairs**

ACCESS SERVICE TARIFF  
PSCK No. 2

CINCINNATI BELL TELEPHONE COMPANY

Original Page 64

2. General Regulations (Cont'd)

2.5 Connections

2.5.1 General

Equipment and Systems (i.e., terminal equipment, multiline terminating systems and communications systems) may be connected with Switched and Special Access Service furnished by the Telephone Company where such connection is made in accordance with the provisions specified in Technical Reference Publication AS No. 1 and in 2.1 preceding.

PUBLIC SERVICE COMMISSION  
OF KENTUCKY  
EFFECTIVE

MAR 3 1992

PURSUANT TO 807 KAR 5:011,

Effective: <sup>SECTION 9.13</sup> March 3, 1992

BY: George J. Lally  
PUBLIC SERVICE COMMISSION MANAGER

Issued: February 7, 1992

Robert E. Aigmon for President, Cincinnati, Ohio

**Vice President - Regulatory Affairs**

ACCESS SERVICE TARIFF  
PSCK No. 2

CINCINNATI BELL TELEPHONE COMPANY

2nd Revised Page 65  
Cancels 1st Revised Page 65

2. General Regulations (Cont'd)

2.6 Definitions

Certain terms used herein are defined as follows:

Access Code

The term "Access Code" denotes a uniform five or seven digit code assigned by the Telephone Company to an individual customer. The five digit code has the form 10XXX, and the seven digit code has the form 101-XXXX and 950-xxxx. (C)  
(C)

Access Minutes

The term "Access Minutes" denotes that usage of exchange facilities in intrastate for the purpose of calculating chargeable usage. On the originating end of an intrastate call, usage is measured from the time the originating end user's call is delivered by the Telephone Company to and acknowledged as received by the customer's facilities connected with the originating exchange. On the terminating end of an intrastate call, usage is measured from the time the call is received by the end user in the terminating exchange. Timing of usage at both originating and terminating ends of an intrastate call shall terminate when the calling or called party disconnects, whichever event is recognized first in the originating and terminating exchanges, as applicable.

Access Tandem

The term "Access Tandem" denotes a Telephone Company switching system that provides a concentration and distribution function for originating or terminating traffic between end offices and a customer's premises.

Aggregator

The term "Aggregator" denotes any person that, in the ordinary course of operations, makes telephones available to the public or to transient users of its premises, for interstate telephone calls using a provider of operator services as defined under Part 64.708(b) of the FCC Rules and Regulations. Further included in this definition are universities, hospitals, hotels and other entities which provide services to the general public for users of its premises for interstate calls.

2. General Regulations (Cont'd)

2.6 Definitions (Cont'd)

Answer/Disconnect Supervision

The term "Answer/Disconnect Supervision" denotes the transmission of the switch trunk equipment supervisory signal (off-hook or on-hook) to the customer's point of termination as an indication that the called party has answered or disconnected.

Attenuation Distortion

The term "Attenuation Distortion" denotes the difference in loss at specified frequencies relative to the loss at 1004 Hz, unless otherwise specified.

Automatic Number Identification (ANI)

The term "Automatic Number Identification (ANI)" denotes the provision of automatic transmission of a seven or ten digit number and information digits to the customer's premises for calls originating in the LATA, to identify the calling station. Also see "Flexible Automatic Number Identification".

Balance (100 Type) Test Line

The term "Balance (100 Type) Test Line" denotes an arrangement in an end office which provides for balance and noise testing.

Bit

The term "Bit" denotes the smallest unit of information in the binary system of notation.

PUBLIC SERVICE COMMISSION  
OF KENTUCKY  
EFFECTIVE

MAR 3 1992

PURSUANT TO 807 KAR 5:011,  
SECTION 9 (1)

BY: 

Effective Service Commission March 3, 1992

Issued: February 7, 1992

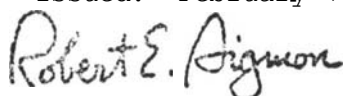
 for President, Cincinnati, Ohio

Vice President - Regulatory Affairs

ACCESS SERVICE TARIFF  
PSCK No. 2

CINCINNATI BELL TELEPHONE COMPANY

1st Revised Page 67  
Cancels Original Page 67

2. General Regulations (Cont'd)

2.6 Definitions (Cont'd)

Business Day

The term "Business Day" denotes the times of day that a company is open for business. Generally, in the business community, these are 8:00 or 9:00 A.M. to 5:00 or 6:00 P.M., respectively, with an hour for lunch, Monday through Friday, resulting in a standard forty (40) hour work week. However, Business Day hours for the Telephone Company may vary based on company policy, union contract and location. To determine such hours the Telephone Company should be contacted at its principle place of business or the hours may be obtained from the Telephone Company's published directory.

(D)

(D)

PUBLIC SERVICE COMMISSION  
OF KENTUCKY  
EFFECTIVE

MAY 23 1995

PURSUANT TO 807 KAR 5011,  
SECTION 9(1)  
BY: Jonathan P. Neal  
FOR THE PUBLIC SERVICE COMMISSION

Issued: June 13, 1995

Effective: May 23, 1995

*Deborah A. Disher*  
President, Cincinnati, Ohio  
Vice President  
Integrated Corporate Planning for

ACCESS SERVICE TARIFF  
PSCK No. 2

CINCINNATI BELL TELEPHONE COMPANY

1st Revised Page 68  
Cancels Original Page 68

2. General Regulations (Cont'd)

2.6 Definitions (Cont'd)

Call

The term "Call" denotes a customer attempt for which the complete address code (e.g., 0-, 911, or 10 digits) is provided to the serving dial tone office.

Call Gapping

The term "Call Gapping" denotes the routing of originating calls to all transmission paths in a trunk group at a prescribed rate of flow, e.g., one call every five seconds, in order to limit (choke) the completion of such traffic. Calls which are denied access, i.e., the choked calls, would be routed to a no-circuit announcement.

Carrier or Common Carrier

See Interexchange Carrier.

(D)  
—  
(D)

PUBLIC SERVICE COMMISSION  
OF KENTUCKY  
EFFECTIVE

OCT 26 1992

PURSUANT TO 807 KAR 5:011,  
SECTION 9 (1)

BY: Shayida  
Effective 10/26/92

Issued: September 24, 1992

Robert E. Aigmon for President, Cincinnati, Ohio

Vice President - Regulatory Affairs

2. General Regulations (Cont'd)

2.6 Definitions (Cont'd)

Central Office

The term "Central Office" denotes a local Telephone Company switching system where Telephone Exchange Service customer station loops are terminated for purposes of interconnection to each other and to trunks.

Central Office Prefix

The term "Central Office Prefix" denotes the first three digits (NXX) of the seven digit telephone number assigned to a customer's Telephone Exchange Service when dialed on a local basis.

Centralized Automatic Reporting on Trunks Testing

The term "Centralized Automatic Reporting on Trunks Testing" denotes a type of testing which includes the capacity for measuring operational and transmission parameters.

Channel(s)

The term "Channel(s)" denotes an electrical or photonic, in the case of fiber optic-based transmission systems, communications path between two or more points of termination.

Channel Service Unit

The term "Channel Service Unit" denotes equipment which performs one or more of the following functions: termination of a digital facility, regeneration of digital signals, detection and/or correction of signal format errors and remote loop back.

Channelize

The term "Channelize" denotes the process of multiplexing-demultiplexing wider bandwidth or higher speed channels into narrower bandwidth or lower speed channels.

PUBLIC SERVICE COMMISSION  
OF KENTUCKY  
EFFECTIVE

MAR 3 1992

PURSUANT TO 807 KAR 5:011,  
SECTION 9 (1)

BY   
Effective March 3, 1992  
PUBLIC SERVICE COMMISSION MANAGER

Issued: February 7, 1992

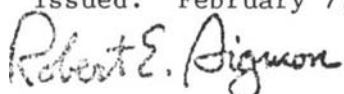
 for President, Cincinnati, Ohio

Vice President - Regulatory Affairs



2. General Regulations (Cont'd)

2.6 Definitions (Cont'd)

C-Message Noise

The term "C-Message Noise" denotes the frequency weighted average noise within an idle voice channel. The frequency weighing, called C-message, is used to simulate the frequency characteristic of the 500-type telephone set and the hearing of the average subscriber.

C-Notched Noise

The term "C-Notched Noise" denotes the C-message frequency weighted noise on a voice channel with a holding tone, which is removed at the measuring end through a notch (very narrow band) filter.

Coin Station

The term "Coin-Station" denotes a location where Telephone Company equipment is provided in a public or semipublic place where Telephone Company customers can originate telephonic communications and pay the applicable charges by inserting coins into the equipment.

Committed Information Rate (CIR)

(N)

The user's throughput that the network commits to support under normal network conditions. This is measured in bits per second.

Committed Burst Size (CBS)

The maximum amount of user data that the network agrees to transfer, under normal conditions, during one second. This is equal to the special access circuit interface speed.

(N)

Common Channel Signaling

The term "Common Channel Signaling" (CCS) denotes a high speed packet switched communications network which is separate (out of band) from the public packet switched and message networks. Its purpose is to carry addressed signaling messages for individual trunk circuits and/or database related services between Signaling Points in the CCS network.

Common Channel Signaling Access Capability

The term "Common Channel Signaling Access Capability" (CCSAC) denotes the option which allows customers access to the CCS signaling network to transmit/receive signals for call set-up out of band. The signaling links established between signaling points of interconnection and the signaling transfer point port. Terminations are requirements of the capability.

ACCESS SERVICE TARIFF  
PSCK No. 2

CINCINNATI BELL TELEPHONE COMPANY

2nd Revised Page 70  
Cancels 1st Revised Page 70

2. General Regulations (Cont'd)

2.6 Definitions (Cont'd)

C-Message Noise

The term "C-Message Noise" denotes the frequency weighted average noise within an idle voice channel. The frequency weighing, called C-message, is used to simulate the frequency characteristic of the 500-type telephone set and the hearing of the average subscriber.

C-Notched Noise

The term "C-Notched Noise" denotes the C-message frequency weighted noise on a voice channel with a holding tone, which is removed at the measuring end through a notch (very narrow band) filter.

Coin Station

The term "Coin-Station" denotes a location where Telephone Company equipment is provided in a public or semipublic place where Telephone Company customers can originate telephonic communications and pay the applicable charges by inserting coins into the equipment.

Common Channel Signaling

The term "Common Channel Signaling" (CCS) denotes a high speed packet switched communications network which is separate (out of band) from the public packet switched and message networks. Its purpose is to carry addressed signaling messages for individual trunk circuits and/or database related services between Signaling Points in the CCS network.

Common Channel Signaling Access Capability

The term "Common Channel Signaling Access Capability" (CCSAC) denotes the option which allows customers access to the CCS signaling network to transmit/receive signals for call set-up out of band. The Signaling Links established between the signaling point of inter-connection and the signaling transfer points and the Signaling Transfer Point Port. Terminations are requirements of the capability. (T) (C)

MAY 23 1995

PURSUANT TO 807 KAR 5011,  
SECTION 9(1)

BY *[Signature]*

Effective: May 23, 1995

Issued: June 23, 1995

*Deborah A. Nisch*  
President, Cincinnati, Ohio

Vice President  
Integrated Corporate Planning for

PUBLIC SERVICE COMMISSION  
KENTUCKY  
EFFECTIVE (C)

ACCESS SERVICE TARIFF  
PSCK No. 2

CINCINNATI BELL TELEPHONE COMPANY

2nd Revised Page 70.1  
Cancels 1st Revised Page 70.1

2. General Regulations (Cont'd)

2.6 Definitions (Cont'd)

Common Channel Signaling Access Capability Signaling Link

The "Common Channel Signaling Access Capability (CCSAC) Signaling Link" provides a 56 kbps Facility dedicated to a single customer which originates at the customer's signaling point of interface in a LATA and terminates at the Telephone Company's Signaling Transfer Point (STP). This facility connects the customer to the STP and is a requirement with the CCSAC option.

(N)  
|  
(N)

Common Line

The term "Common Line" denotes a line, trunk, pay telephone line or other facility provided under the general and/or local exchange service tariffs of the Telephone Company, terminated on a central office switch. A common line-residence is a line or trunk provided under the regulations of the general and/or local exchange service tariffs for a residence Class of Service. A common line-business is a line provided under the regulations of the general and/or local exchange service tariffs for a nonresidence Class of Service. For purposes of this tariff, any reference to "business" is considered to reference "nonresidence".

Communications System

The term "Communications System" denotes channels and other facilities which are capable of communications between terminal equipment.

Conventional Signaling

The inter-machine signaling system which has been traditionally used in North America for the purpose of transmitting the called number's address digits from the originating end office to the switching machine which will terminate the call. In this system, all of the dialed digits are received by the originating switching machine, a path is selected, and the sequence of supervisory signals and outpulsed digits is initiated. No overlap outpulsing, ten-digit ANI, ANI information digits, or acknowledgement wink are included in this signaling sequence.

PUBLIC SERVICE COMMISSION  
OF KENTUCKY  
EFFECTIVE

MAY 23 1995

PURSUANT TO 807 KAR 5011,  
SECTION 9(1)

BY:  Gordon C. Neal   
FOR THE PUBLIC SERVICE COMMISSION

Issued: June 13, 1995  
 Deborah K. Busch   
Vice President  
Integrated Corporate Planning for

President, Cincinnati, Ohio

Effective: May 23, 1995

ACCESS SERVICE TARIFF  
PSCK No. 2

CINCINNATI BELL TELEPHONE COMPANY

1st Revised Page 71  
Cancels Original Page 71

2. General Regulations (Cont'd)

2.6 Definitions (Cont'd)

Customer(s)

The term "Customer(s)" denotes any individual, partnership, association, joint-stock company, trust, corporation, or governmental entity or other entity which subscribes to the services offered under this tariff, including both Interexchange Carriers (ICs) and End Users.

Data Base Query

The term "Data Base Query" denotes a Signaling System 7 (SS7) message launched from a Service Switching Point (SSP) requesting processing instructions or service data contained in a centralized data base.

(N)  
|  
(N)

Data Transmission (107 Type) Test Line

The term "Data Transmission (107 Type) Test Line" denotes an arrangement which provides for a connection to a signal source which provides test signals for one-way testing of data and voice transmission parameters.

Decibel

The term "Decibel" denotes a unit used to express relative difference in power, usually between acoustic or electric signals, equal to ten (10) times the common logarithm of the ratio of two signal powers.

Decibel Reference Noise C-Message Referenced to 0

The term "Decibel Reference Noise C-Message Referenced to 0" denotes noise power in "Decibel Reference Noise C-Message Weighting" referred to or measured at a zero transmission level point.

(M)  
|  
(M)

Decibel Reference Noise C-Message Weighting

The term "Decibel Reference Noise C-Message Weighting" denotes noise power measurements with C-Message Weighting in decibels relative to a reference 1000 Hz tone of 90 dB below 1 milliwatt.

Detail Billing

The term "Detail Billing" denotes the listing of each message and/or rate element for which charges to a customer are due on a bill effective by the Telephone Company.

**PUBLIC SERVICE COMMISSION**

OF KENTUCKY

~~EFFECTIVE~~

Certain regulations previously found on this page can now be found on page 70.1.

MAY 1 1993

Issued: March 25, 1993

PURSHANI: TO 807 KAR 5.01 1993

EFFECTIVE: May 1, 1993

SECTION 9 (1)

*Robert E. Aigmon*

for

President, Cincinnati, Ohio

BY: *Glenn Miller*  
PUBLIC SERVICE COMMISSION MANAGER

**Vice President - Regulatory Affairs**

ACCESS SERVICE TARIFF  
PSCK No. 2

CINCINNATI BELL TELEPHONE COMPANY

1st Revised Page 72  
Cancels Original Page 72

2. General Regulations (Cont'd)

2.6 Definitions (Cont'd)

Direct - Trunked Transport Facility

The term "Direct-Trunked Transport Facility" denotes a Switched Transport facility between a customer's premises serving wire center and an end office or between a customer's serving wire center and an access tandem that provides a customer with dedicated switched access transport.

Directory Assistance (Intrastate InterLATA)

The term "Directory Assistance" denotes the provision of telephone numbers by a Telephone Company operator when the operator location is accessed by a customer premises by sending the appropriate signals, i.e. off-hook, 411 555-1212 or (NPA) 555-1212.

Directory Assistance Location (Intrastate InterLATA)

The term "Directory Assistance Location" denotes a Telephone Company office where Telephone Company equipment first receives the Directory Assistance call from a customer's premises and selects the first operator position to respond to the Directory Assistance call.

Dual Tone Multifrequency Address Signaling

The term "Dual Tone Multifrequency Address Signaling" denotes a type of signaling that is an optional feature of Switched Access Feature Group A. It may be utilized when Feature Group A is being used in the terminating direction (from the point of termination with the customer to the local exchange end office). An office arranged for Dual Tone Multifrequency Signaling would expect to receive address signals from the customer in the form of Dual Tone Multifrequency signals.

Echo Control

The term "Echo Control" denotes the control of reflected signals in a telephone transmission path.

Echo Path Loss

The term "Echo Path Loss" denotes the measure of reflected signal at a 4-wire point of termination without regard to the send and receive Transmission Level Point.

Certain regulations previously found on this page now appear on Page 73.

(N)  
|  
(N)

PUBLIC SERVICE COMMISSION  
OF KENTUCKY  
EFFECTIVE

MAY 23 1995

PURSUANT TO 807 KAR 5.011,  
SECTION 9 (1)  
BY: *James C. Neal*  
FOR THE PUBLIC SERVICE COMMISSION

Issued: June 13, 1995  
*Deborah Hesch*  
Vice President  
Integrated Corporate Planning for

Effective: May 23, 1995  
President, Cincinnati, Ohio

ACCESS SERVICE TARIFF  
PSC No. 2

CINCINNATI BELL TELEPHONE COMPANY

3rd Revised Page 73  
Cancels 2nd Revised Page 73

2. General Regulations (Cont'd)

(C)

2.6 Definitions (Cont'd)

Echo Return Loss

The term "Echo Return Loss" denotes a frequency weighted measure of return loss over the middle of the voice band (approximately 500 to 2500hz), where talker echo is most annoying

Effective 2-Wire

The term "Effective 2-Wire" denotes a condition which permits the simultaneous transmission in both directions over a channel, but it is not possible to insure independent information transmission in both directions. Effective 2-wire channels may be terminated with 2-wire or 4-wire interfaces.

Effective 4-Wire

The term "Effective 4-Wire" denotes a condition which permits the simultaneous independent transmission of information in both directions over a channel. The method of implementing effective 4-wire transmission is at the discretion of the Telephone Company (physical, time domain, frequency-domain separation or echo cancellation techniques). Effective 4-wire channels may be terminated with a 2-wire interface at the customer's premises. However, when terminated 2-wire, simultaneous independent transmission cannot be supported because the two wire interface combines the transmission path into a single path.

800 Access Service

800 Access Service denotes a service which provides 10-digit screening as an originating switched access service. This 10-digit screening determines the Interexchange Carrier to which a call is routed. As set forth in this tariff, the term 800 Access Service (or 800 series) includes the following numbers; 800, 888, 877, 866, 855, 844, 833, 822.

Electronic Access

The term 'Electronic Access' denotes the capability to electronically transmit data messages between a customer's computer and a Telephone Company computer.

End Office Switch

The term "End Office Switch" denotes a local Telephone Company switching system where Telephone Exchange Service customer station loops are terminated for purposes of interconnection to trunks. Included are Remote Switching Modules and Remote Switching Systems served by a host office in a different wire center.

Certain regulations previously found on this page now appear on Page 74.

Issued: March 25, 1999

Effective: January 25, 1999

President, Cincinnati, Ohio

2. General Regulations (Cont'd)

2.6 Definitions (Cont'd)

End User

The term "End User" denotes any customer of an intrastate telecommunications service that is not a carrier, except that a carrier other than a telephone company shall be deemed to be an "end user" when such carrier uses a telecommunications service for administrative purposes and a person or entity that offers telecommunications services exclusively as a reseller shall be deemed to be an "end user" if all resale transmissions offered by such reseller originate on the premises of such reseller.

(M)  
|  
(M)

Entrance Facility

The term "Entrance Facility" denotes a Switched Transport dedicated facility between a customer premises and a customer's premises serving wire center that provides a customer with switched access transport between the customer's premises and its serving wire center.

Entry Switch

See First Point of Switching

Envelope Delay Distortion

The term "Envelope Delay Distortion" denotes a measure of the linearity of the phase shift versus frequency of a channel.

Equal Access Signaling

The signaling system which is used, by equal access end offices, to transmit originating information and address digits to the customer's premises and which includes the means of verifying the receipt of these address digits. Features and options of this system include overlap outpulsing, identification of the type of call, identification of a ten-digit telephone number of the calling party, and acknowledgement wink supervisory signals.

Equal Level Echo Path Loss

The term "Equal Level Echo Path Loss" (ELEPL) denotes the measure of Echo Path Loss (EPL) at a 4-wire interface which is corrected by the difference between the send and receive Transmission Level Point (TLP). [ELEPL = EPL - TLP (send) + TLP (receive)]

Excess Burst Size (EBS)

The maximum amount of uncommitted data exceeding the CBS that the network will attempt to deliver during one second.

(N)  
|  
(N)

Certain regulations found on this page formerly appeared on Page 73

(C)

Issued: February 23, 1999

Effective: January 25, 1999

CINCINNATI BELL TELEPHONE COMPANY

2nd Revised Page 75  
Cancels 1st Revised Page 75

2. General Regulations (Cont'd)

2.6 Definitions (Cont'd)

Exchange

The term "Exchange" denotes a unit generally smaller than a Local Access and Transport Area, established by the Telephone Company for the administration of communications service in a specified area which usually embraces a city, town or village and its environs. It consists of one or more central offices together with the associated facilities used in furnishing communications service within that area. One or more designated exchanges comprise a given Local Access and Transport Area.

Exit Message

The term "Exit Message" denotes a SS7 message sent to an end office by the Telephone Company's tandem switch to mark the Carrier Connect Time when the Telephone Company's tandem switch sends an Initial Address Message to an Interexchange customer.

Field Identifier

The term "Field Identifier" denotes two to four characters that are used on service orders to convey specific instructions. Field Identifiers may or may not have associated data. Selected Field Identifiers are used in Telephone Company billing systems to generate nonrecurring charges.

First-Come, First-Served

The term "First-Come, First-Served" denotes a procedure followed when the first service order received will be the first service order processed.

First Point of Switching

The term "First Point of Switching" denotes the first Telephone Company location at which switching occurs on the terminating path of a call proceeding from the customer premises to the terminating end office and, at the same time, the last Telephone Company location at which switching occurs on the originating path of a call proceeding from the originating end office to the customer premises.

Certain regulations found on this page formerly appeared on Page 74.

Issued: June 13, 1995

Effective: May 23, 1995

*Deborah A. Nisch* resident, Cincinnati, Ohio  
Vice President  
Integrated Corporate Planning for

(M)  
|  
(M)

PUBLIC SERVICE COMMISSION  
OF KENTUCKY  
EFFECTIVE

MAY 23 1995

PURSUANT TO 807 KAR 5.011,  
SECTION 9(1)  
BY: *James B. Neal*  
FOR THE PUBLIC SERVICE COMMISSION



2. General Regulations (Cont'd)

2.6 Definitions (Cont'd)

Flexible Automatic Number Identification (Flex ANI)

The term "Flexible Automatic Number Identification" denotes the provision of additional values for the information indicator digits available with the Automatic Number Identification feature on originating calls. The additional information digits are used to identify the class or type of service from which the call originated

Frame

In Frame Relay Service, the term "Frame" denotes a group of data bits in a specific format, which enables network equipment to recognize the meaning and purpose of the specific bits.

(N)

(N)

Frequency Shift

The term "Frequency Shift" denotes the change in the frequency of a tone as it is transmitted over a channel.

Grandfathered

The term "Grandfathered" denotes Terminal Equipment, Multiline Terminating Systems and Protective Circuitry directly connected to the facilities utilized to provide services under the provisions of this tariff, and which are considered grandfathered under Part 68 of the F.C.C.'s Rules and Regulations.

Host Computer

The term "Host Computer" denotes one or more processors) and its (their) associated software and peripheral equipment which together form an intelligent processor or device connected to a network that satisfies the needs of remote users connected to such processor or device.

ACCESS SERVICE TARIFF  
PSCK No. 2

CINCINNATI BELL TELEPHONE COMPANY

1st Revised Page 77  
Cancels Original Page 77

2. General Regulations (Cont'd)

2.6 Definitions (Cont'd)

Host Office

The term "Host Office" denotes an electronic switching system which provides call processing capabilities for one or more Remote Switching Modules or Remote Switching Systems.

Hundred Call Seconds

A standard unit of traffic load that is equal to 100 seconds of usage or capacity of a group of servers (e.g., trunks).

(N)  
|  
(N)

Immediately Available Funds

The term "Immediately Available funds" denotes a corporate or personal check drawn on a bank account and funds which are available for use by the receiving party on the same day on which they are received and include U.S. Federal Reserve bank wire transfers, U.S. Federal Reserve Notes (paper cash), U.S. coins, U.S. Postal Money Orders and New York Certificates of Deposit.

Impedance Balance

The term "Impedance Balance" denotes the method of expressing Echo Return Loss and Singing Return Loss at a 4-wire interface whereby the gains and/or loss of the 4-wire portion of the transmission path, including they hybrid, are not included in the specification.

Impulse Noise

The term "Impulse Noise" denotes any momentary occurrence of noise on a channel over a specified threshold level. It is evaluated by counting the number of occurrences which exceed the threshold.

Individual Case Basis

The term "Individual Case Basis" denotes a condition, **PUBLIC SERVICE COMMISSION** regulations, if applicable, rates and charges for an **OFFERED UNDER** the provision of this tariff are developed based on the circumstances in each case.

OCT 26 1992

PURSUANT TO 807 KAR 5:011.

Certain regulations previously found on this page can now be found **SECTION 17B.**

Issued: September 24, 1992

Effective: October 1, 1992  
**PUBLIC SERVICE COMMISSION**

*Robert J. ...*

for President, Cincinnati, Ohio

Vice President - Regulatory Affairs

ACCESS SERVICE TARIFF  
PSCK No. 2

CINCINNATI BELL TELEPHONE COMPANY

2nd Revised Page 78  
Cancels 1st Revised Page 78

2. General Regulations (Cont'd)

2.6 Definitions (Cont'd)

Initial Address Message

The term "Initial Address Message" denotes a SS7 message sent in the forward direction to initiate trunk setup with the busying of an outgoing trunk which carries the information about that trunk along with other information relating to the routing and handling of the call to the next switch.

Inserted Connection Loss

The term "Inserted Connection Loss" denotes the 1004 Hz power difference (in dB) between the power at the originating end and the power reaching the terminating end through the inserted connection.

Interconnection Charge

The **Interconnection Charge** recovers the costs associated with Switched Transport that are not recovered by the Entrance Facilities, Direct-Trunked Transport, Tandem-Switched Transport, Multiplexing, or CCSAC rates. The Interconnection Charge applies to all access minutes of use (i.e., both Tandem-Switched and Direct Trunked).

Interexchange Carrier (IC) or Interexchange Common Carrier

The terms "Interexchange Carrier" (IC) or "Interexchange Common Carrier" denote any individual, partnership, association, joint-stock company, trust, governmental entity or corporation engaged for hire in intrastate communications by wire or radio, between two or more exchanges.

Intermodulation Distortion

The term "Intermodulation Distortion" denotes a measure of the nonlinearity of a channel. It is measured using four tones, and evaluating the ratios (in dB) of the transmitted composite four-tone signal power to the second-order products of the tones (R2), and the third-order products of the tones (R3).

Interstate Communications

The term "Interstate Communications" denotes both interstate and foreign communications.

(N)  
|  
(N)

PUBLIC SERVICE COMMISSION  
OF KENTUCKY  
OFFICE OF THE SECRETARY

MAY 23 1995

PURSUANT TO 807 KAR 5.011,  
SECTION 9(1)

BY: \_\_\_\_\_  
SECRETARY

Issued: June 13, 1995

Effective: May 23, 1995

*Deborah A. Nisch*  
Vice President  
Integrated Corporate Planning for

ACCESS SERVICE TARIFF  
PSCK No. 2

CINCINNATI BELL TELEPHONE COMPANY

1st Revised Page 79  
Cancels Original Page 79

2. General Regulations (Cont'd)

2.6 Definitions (Cont'd)

Intrastate Communications

The term "Intrastate Communications" denotes any communications within a state subject to oversight by a state regulatory commission as provided by the laws of the state involved.

Letter of Authorization (LOA)

The term "Letter of Authorization" (IDA) denotes the Signed Authorization form from a customer designating the primary IC (PIC) for interLATA access.

(N)  
|  
(N)

Line-Side Connection

The term "Line-Side Connection" denotes a connection of a transmission path to the line side of a local exchange switching system.

Local Access and Transport Area

The term "Local Access and Transport Area" denotes a geographic area established for the purpose of defining the area within which the Telephone Company will offer its telecommunications services. For purposes of this tariff, the term LATA denotes the Cincinnati Market Area, which encompasses the Rate Centers set forth in 15, following as well as all exchanges associated with such Rate Centers.

PUBLIC SERVICE COMMISSION  
OF KENTUCKY  
EFFECTIVE

MAY 23 1995

PURSUANT TO 807 KAR 5011,  
SECTION 9 (1)

BY:  Gordon C. Hall   
FOR THE PUBLIC SERVICE COMMISSION

Issued: June 13, 1995

Effective: May 23, 1995

Deborah A. Nisch  President, Cincinnati, Ohio

Vice President  
Integrated Corporate Planning for

ACCESS SERVICE TARIFF  
PSC No. 2

CINCINNATI BELL TELEPHONE COMPANY

Original Page 80

2. General Regulations (Cont'd)

2.6 Definitions (Cont'd)

Local Tandem Switch

The term "Local Tandem Switch" denotes a local Telephone Company switching unit by which local or access telephonic communications are switched to and from an End Office Switch.

Loop Around Test Line

The term "Loop Around Test Line" denotes an arrangement utilizing a Telephone Company central office to provide a means to make certain two-way transmission tests on a manual basis. This arrangement has two central office terminations, each reached by means of separate telephone numbers and does not require any specific customer premises equipment. Equipment subject to this test arrangement is at the discretion of the customer.

Loss Deviation

The term "Loss Deviation" denotes the variation of the actual loss from the designed value.

Maritime Radio Common Carrier

The term "Maritime Radio Common Carrier" denotes a carrier which is regulated under Part 81 of the Federal Communications Commission's Rules and Regulations.

**PUBLIC SERVICE COMMISSION  
OF KENTUCKY  
EFFECTIVE**

MAR 3 1992

**PURSUANT TO 807 KAR 5:011,  
SECTION 9(1)**

BY: Sharon Fuller  
PUBLIC SERVICE COMMISSION MANAGER

Issued: February 7, 1992  
Robert E. Aigmon for  
President, Cincinnati, Ohio

Effective: March 3, 1992

**Vice President - Regulatory Affairs**

ACCESS SERVICE TARIFF  
PSCK No. 2

CINCINNATI BELL TELEPHONE COMPANY

Original Page 81

2. General Regulations (Cont'd)

2.6 Definitions (Cont'd)

Major Fraction Thereof

The term "Major Fraction Thereof" is any period of time in excess of 1/2 of the stated amount of time. As an example, in considering a period of 24 hours, a major fraction thereof would be any period of time in excess of 12 hours exactly. Therefore, if a given service is interrupted for a period of thirty six hours and fifteen minutes, the customer would be given a credit allowance for two twenty-four hour periods for a total of forty eight hours.

Message

The term "Message" denotes a "call" as defined preceding.

Milliwatt (102 Type) Test Line

The term "Milliwatt (102 Type) Test Line" denotes an arrangement in an end office which provides a 1004 Hz tone at 0 dBm0 for one-way transmission measurements towards the customer's premises from the Telephone Company end office.

Mobile Telephone Switching Office

The term "Mobile Telephone Switching Office" denotes a Cellular Mobile Carrier switching system that is used to terminate mobile stations for purposes of interconnection to each other and to trunks interfacing with the public switched network.

**PUBLIC SERVICE COMMISSION  
OF KENTUCKY  
EFFECTIVE**

MAR 3 1992

**PURSUANT TO 807 KAR 5:011,  
SECTION 9 (1)**

BY: George Helle  
PUBLIC SERVICE COMMISSION MANAGER

Issued: February 7, 1992

Effective: March 3, 1992

Robert E. Aigmon for

President, Cincinnati, Ohio

**Vice President - Regulatory Affairs**

2. General Regulations (Cont'd)

2.6 Definitions (Cont'd)

Network Control Signaling

The term "Network Control Signaling" denotes the transmission of signals used in the telecommunications system which perform functions such as supervision (control, status, and charge signals), address signaling (e.g., dialing), calling and called number identifications, rate of flow, service selection error control and audible tone signals (call progress signals indicating re-order or busy conditions, alerting, coin denominations, coin collect and, coin return tones) to control the operation of the telecommunications system.

Network Management Control

The term "Network Management Control" denotes the type of control that the Telephone Company may need to implement when a substantial number of calls are expected during a short period of time.

North American Numbering Plan

The term "North American Numbering Plan" denotes a three-digit area (Numbering Plan Area) code and a seven-digit telephone number made up of a three-digit Central Office code plus a four-digit station number.

Off-hook

The term "Off-hook" denotes the active state of a Switched Access or a Telephone Exchange Service line.

On-hook

The term "On-hook" denotes the idle state of a Switched Access or a Telephone Exchange Service line.

Open Circuit Test Line

The term "Open Circuit Test Line" denotes an arrangement in an end office which provides termination of a trunk or line by means of an inductor of several Henries. The impedance is so high as to be virtually an open circuit to alternating current at the frequencies used in voice communications.

MAR 3 1992

PURSUANT TO 807 KAR 5:011.  
SECTION a(1)

Issued: February 7, 1992

*Robert E. Aignon* for

President, Cincinnati, Ohio

Effective: *March 3, 1992*  
PUBLIC SERVICE COMMISSION MANAGER

**Vice President - Regulatory Affairs**

2. General Regulations (Cont'd)

2.6 Definitions (Cont'd)

Originating Direction

The term "Originating Direction" denotes the use of Access Service for the origination of calls from an end users premises to an IC premises.

Overlap Outpulsing

The feature of the equal access signaling system which permits initiation of pulsing to the customer's premises before the calling subscriber has completed dialing an originating call.

Pay Telephone

The term "Pay Telephone" denotes Telephone Company provided instruments and related facilities that are available to the general public for public convenience and necessity, including public and semipublic telephones, and coinless telephones.

Peaked Service

The term "Peaked Service" denotes a service that will produce a substantial call volume during a short period of time, e.g., media stimulated events, that may cause excessive network congestion.

Phase Jitter

The term "Phase Jitter" denotes the unwanted phase variations of a signal.

Point of Termination

The term "Point of Termination" denotes the point of demarcation within a customer-designated premises at which the Telephone Company's responsibility for the provision of Access Service ends.

Premises

The term "Premises" denotes a building or a portion of a building in a multitenant building, or buildings on continuous property (except Railroad Right-of-way, etc.) not separated by a public highway.

Prime Service Vendor

The term "Prime Service Vendor" denotes the status of the Telephone Company when contracting directly with the user of TSP service.

PUBLIC SERVICE COMMISSION  
OF KENTUCKY  
EFFECTIVE

MAR 3 1992

PURSUANT TO 807 KAR 5:011.  
SECTION 9 (1)

BY: *Clayton Hallee*  
COMMUNICATIONS MANAGER

Issued: February 7, 1992

Effective: March 5, 1992

*Robert E. Aigmon*

for

President, Cincinnati, Ohio

Vice President - Regulatory Affairs



2. General Regulations (Cont'd)

2.6 Definitions (Cont'd)

Radio Common Carrier

The term "Radio Common Carrier" denotes a carrier which is regulated under Part 22 of the Federal Communications Commission's Rules and Regulations.

Remote Switching Modules and/or Remote Switching Systems

The term "Remote Switching Modules and/or Remote Switching Systems" denotes remotely controlled electronic end office switches which obtain their call processing capability from an ESS-type Host Office. The Remote Switching Modules and/or Remote Switching Systems cannot accommodate direct trunks to a customer.

Return Loss

The term "Return Loss" denotes a measure of the similarity between the two impedances at the junction of two transmission paths. The higher the return loss, the greater the similarity.

Registered Equipment

The term "Registered Equipment" denotes the customer's premises equipment which complies with and has been approved within the Registration Provisions of Part 68 of the F.C.C.'s Rules and Regulations.

Service Switching Point

The term "Service Switching Point" (SSP) denotes a switch in the Telephone Company's Common Channel Signaling (CCS) network equipped with the functionality to interact with a data base using Signaling System 7 (SS7) messages to obtain call routing information.

Serving Wire Center

The term "Serving Wire Center" denotes the wire center from which the customer designated premises would normally obtain dial tone from the Telephone Company.

(N)  
|  
(N)

**PUBLIC SERVICE COMMISSION  
OF KENTUCKY  
EFFECTIVE**

Certain regulations previously found on this page can now be found on page 85.

MAY 1 1993

Issued: March 25, 1993

PURSUANT TO 807 KAR 5.011  
Effective: May 1, 1993  
SECTION 9 (1)

*Robert E. Aigmon*

for

President, Cincinnati, Ohio

BY: *Shirley Hallett*  
PUBLIC SERVICE COMMISSION MANAGER

ACCESS SERVICE TARIFF  
PSCK No. 2

CINCINNATI BELL TELEPHONE COMPANY

3rd Revised Page 85  
Cancels 2nd Revised Page 85

2. General Regulations (Cont'd)

2.6 Definitions (Cont'd)

Seven Digit Manual Test Line

The term "Seven Digit Manual Test Line" denotes an arrangement which allows the customer to select balance, milliwatt and synchronous test lines by manually dialing a seven digit number over the associated access connection.

Short Circuit Test Line

The term "Short Circuit Test Line" denotes an arrangement in an end office which provides termination of a trunk or line by means of a capacitor of at least four microfarads. The impedance is so low as to be virtually a short circuit to alternating current at the frequencies used in voice communications.

Signal-to-C Notched Noise Ratio

The term "Signal-to-C Notched Noise Ratio" denotes the ratio in dB of a test signal to the corresponding C-Notched Noise, i.e., the level in dB by which the signal exceeds the noise.

Signaling Point of Interconnection

The term "Signaling Point of Interconnection" denotes the customer designated location where SS7 signaling information is exchanged between the Telephone Company and the Customer.

PUBLIC SERVICE COMMISSION  
OF THE STATE OF OHIO  
EXECUTIVE

MAY 23 1995

PURSUANT TO 807 KAR 5011,  
SECTION 9 (1)

BY: James C. Neal  
FOR THE PUBLIC SERVICE COMMISSION

Certain regulations previously found on this page can now be found on Page 85.1.

Issued: June 13, 1995

Effective: May 23, 1995



President, Cincinnati, Ohio

Vice President  
Integrated Corporate Planning for

ACCESS SERVICE TARIFF  
PSCK No. 2

PUBLIC SERVICE COMMISSION  
OF KENTUCKY  
EFFECTIVE Original Page 85.1

CINCINNATI BELL TELEPHONE COMPANY

MAY 23 1995

PURSUANT TO 807 KAR 5011,  
SECTION 9(1)

BY: *James C. Smith*  
FOR THE PUBLIC SERVICE COMMISSION

2. General Regulations (Cont'd)

2.6 Definitions (Cont'd)

Signaling System 7

The term "Signaling System 7" denotes common channel out of band signaling using the SS7 protocol developed by the Consultative Committee for International Telephone and Telegraph (CCITT) and the American National Standards Institute (ANSI).

Signaling Transfer Point

The term "Signaling Transfer Point" denotes a specialized switch which provides CCS network access and performs SS7 message screening, routing, and/or transferring of such signaling information through the common channel signaling network.

Signaling Transfer Point Port Termination

The "Signaling Transfer Point Port Termination" provides a customer dedicated point of interface at the Telephone Company's STP for each of the customer's CCSAC Signaling Links.

Singing Return Loss

The term "Singing Return Loss" denotes the frequency weighted measure of return loss at the edges of the voiceband (200 to 500 Hz and 2500 to 3200 Hz), where singing (instability) problems are most likely to occur.

Special Order

The term "Special Order" denotes an order for a Directory Assistance Service or an order for a Billing and Collection Service.

Subcontractor

The term "Subcontractor" denotes the status of the Telephone Company when contracting directly with a Prime Service Vendor to provide TSP to a service user.

(M)

(M)

(N)

(N)

(M)

(M)

Certain regulations on this page formerly appeared on Page 85.

Issued: June 13, 1995

Effective: May 23, 1995

*Deborah A. Nichols*  
President, Cincinnati, Ohio  
Vice President  
Integrated Corporate Planning for

2. General Regulations (Cont'd)

2.6 Definitions (Cont'd)

Subtending End Office of an Access Tandem

The term "Subtending End Office of an Access Tandem" denotes an end office that has trunk group routing through that tandem.

Switching System

The term "Switching System" denotes the hardware and/or software utilized by the Telephone Company for the establishment and maintenance of a given central office.

Synchronous Optical Network (SONET) - Is a set of international standards for fiber optic-based transmission systems. SONET defines standard optical carrier transmission rates and utilizes a modular multiplexing approach based on the application of Synchronous Transport Signals (STS).

(N)  
|  
(N)

Synchronous Test Line

The term "Synchronous Test Line" denotes an arrangement in an end office which performs marginal operational tests of supervisory and ring-tripping functions

Synchronous Transport Signal (STS-1)

A 51.84 Mbps signal within a SONET optical carrier signal. The STS-1 signal consists of overhead and synchronous payload envelope (SPE). The overhead part of the signal is used for controlling, framing and maintaining the signal. The SPE is used to transport the customer's data.

(N)  
|  
(N)

Tandem-Switched Transmission Charge

The Tandem-Switched Transmission charge is a mileage sensitive, per minute of use rate which applies to the transmission of the customer's traffic from the customer's serving wire center, through the Telephone Company's Access Tandem, to the customer designated Telephone Company end office(s), or from the Access Tandem to the end office(s).

Tandem-Switching Charge

The Tandem-Switching charge is a per minute of use rate element which applies to the switching used to move a customer's traffic through the Telephone Company's Access Tandem to the Telephone Company's end office(s).

Tandem-Switching Provider

A Tandem Switch Provider or TSP can be a competitive access provider (CAP), an interexchange carrier (IXC) and/or an end user, which provides tandem switching services.

(N)

Terminating Direction

The term "Terminating Direction" denotes the use of Access Service for the completion of calls from a customer premises to an end user premises

2. General Regulations (Cont'd)

2.6 Definitions (Cont'd)

Transmission Measuring (105 Type) Test Line/Responder

The term "Transmission Measuring (105 Type) Test Line/Responder" denotes an arrangement in an end office which provides far-end access to a responder and permits two-way loss and noise measurements to be made on trunks from a near end office.

Transmission Path

The term "Transmission Path" denotes an electrical path capable of transmitting signals within the range of the service offering, e.g., a voice grade transmission path is capable of transmitting voice frequencies within the approximate range of 300 to 3000 Hz. A transmission path is comprised of physical or derived channels consisting of any form or configuration of facilities typically used in the telecommunications industry.

Trunk

The term "Trunk" denotes a communications path connecting two switching systems in a network, used in the establishment of an end-to-end connection.

Trunk Access Limitation

The term "Trunk Access Limitation" denotes the routing of originating calls to a specified number of transmission paths in a trunk group in order to limit (choke) the completion of such traffic. Calls which could not be completed over the subset of transmission paths in the trunk group, i.e., the choked calls, would be routed to reorder tone.

Trunk Group

The term "Trunk Group" denotes a set of trunks which are engineered as a unit for the establishment of connections between switching systems in which all of the communications paths are interchangeable.

PUBLIC SERVICE COMMISSION  
OF KENTUCKY  
EFFECTIVE

MAR 3 1992

PURSUANT TO 807 KAR 5:011,  
SECTION 9 (1)

BY: Charles H. Helle  
PUBLIC SERVICE COMMISSION MANAGER

Issued: February 7, 1992

Effective: March 3, 1992

Robert E. Aiguon for President, Cincinnati, Ohio

Vice President - Regulatory Affairs

2. General Regulations (Cont'd)

2.6 Definitions (Cont'd)

Trunk-Side Connection

The term "Trunk-Side Connection" denotes the connection of a transmission path to the trunk side of a local exchange switching system.

Two-Wire to Four-Wire Conversion

The term "Two-Wire to Four-Wire Conversion" denotes an arrangement which converts a four-wire transmission path to a two-wire transmission path to allow a four-wire facility to terminate in a two-way entity (e.g., a central office switch).

Uniform Service Order Code

The term "Uniform Service Order Code" denotes a three or five character alphabetic, numeric, or an alphanumeric code that identifies a specific item of service or equipment. Uniform Service Order Codes are used in the Telephone Company billing system to generate recurring and nonrecurring charges.

V and H Coordinates Method

The term "V and H Coordinates Method" denotes a method of computing airline miles between two points by utilizing an established formula which is based on the vertical and horizontal coordinates of the two points.

WATS Serving Office

The term "WATS Serving Office" denotes a telephone company designated serving wire center where switching, screening and/or recording functions are performed in connection with the closed-end of WATS or WATS-type services.

Wire Center

The term "Wire Center" denotes a building in which one or more central offices, used for the provision of Telephone Exchange Services, are located.

PUBLIC SERVICE COMMISSION  
OF KENTUCKY  
EFFECTIVE

MAR 3 1992

PURSUANT TO 807 KAR 5:011,  
SECTION 9 (1)

BY: Shirley H. Hall  
PUBLIC SERVICE COMMISSION MANAGER

Issued: February 7, 1991

Effective: March 3, 1992

Robert E. Aigmon

for

President, Cincinnati, Ohio

Vice President - Regulatory Affairs

ACCESS SERVICE TARIFF  
PSCK No. 2

CINCINNATI BELL TELEPHONE COMPANY

Original Page 89

3. Carrier Common Line Access Service

The Telephone Company will provide Carrier Common Line Access Service (Carrier Common Line Access) to customers in conjunction with Switched Access Service provided in Section 6 of this tariff.

3.1 General Description

Carrier Common Line Access provides for the use of Telephone Company common lines by customers for access to end users to furnish Intrastate Communications.

Access is Switched Access Service provided to ICs under this tariff which furnish intrastate MTS/WATS.

In addition, a Special Access Surcharge as set forth in 7.4 following will apply to intrastate special access service provided by the Telephone Company to a customer, in accordance with regulations as set forth in 7.4 following.

PUBLIC SERVICE COMMISSION  
OF KENTUCKY  
EFFECTIVE

MAR 3 1992

PURSUANT TO 807 KAR 5:011  
SECTION 9 (1)

BY: George Helle  
PUBLIC SERVICE COMMISSION MANAGER

Issued: February 7, 1992

Effective: March 3, 1992

Robert E. Aigmon

for

President, Cincinnati, Ohio

Vice President - Regulatory Affairs

ACCESS SERVICE TARIFF  
PSCK No. 2

CINCINNATI BELL TELEPHONE COMPANY

Original Page 90

3. Carrier Common Line Access Service (Cont'd)

3.2 Limitations

- (A) A telephone number is not provided with Carrier Common Line Access.
- (B) Detail billing is not provided for Carrier Common Line Access.
- (C) Directory listings are not included in the rates and charges for Carrier Common Line Access.
- (D) Intercept arrangements are not included in the rates and charges for Carrier Common Line Access.
- (E) All line side connections provided in the same combined access group will be limited to the same features and operating characteristics.
- (F) All trunk side connections provided in the same combined access group will be limited to the same features and operating characteristics.
- (G) Where Switched Access Services are connected with Special Access Services at Telephone Company Designated WATS Serving Offices for the provisions of WATS or WATS-type Services, Switched Access Service minutes which are carried on that end of the service (i.e., originating minutes for outward WATS and WATS-type services and terminating minutes for inward WATS and WATS-type services) shall not be assessed Carrier Common Line Access per minute charges.

**PUBLIC SERVICE COMMISSION  
OF KENTUCKY  
EFFECTIVE**

MAR 3 1992

PURSUANT TO 807 KAR 5:011,  
SECTION 9 (1)

BY: Sharon Kelle  
PUBLIC SERVICE COMMISSION MANAGER

Issued: February 7, 1992

Effective: March 3, 1992

Robert E. Aigmon for  
President, Cincinnati, Ohio

**Vice President - Regulatory Affairs**



ACCESS SERVICE TARIFF  
PSCK No. 2

CINCINNATI BELL TELEPHONE COMPANY

Original Page 91

3. Carrier Common Line Access Service (Cont'd)

3.3 Undertaking of the Telephone Company

- (A) Where the customer is provided with Switched Access Service under other sections of this tariff, the Telephone Company will provide the use of Telephone Company common lines by a customer for access to end users at rates and charges as set forth in 3.8 following.
- (B) Where the customer is reselling MIS and/or MTS-type service(s) on which the Carrier Common Line and Switched Access charges have been assessed, the customer may, at the option of the customer, obtain Feature Group A, Feature Group B or Feature Group D Switched Access Service under this tariff as set forth in Section 6 following for originating and/or terminating access in the local exchange. Such access group arrangements whether single lines or trunks or multiline hunt groups or trunk groups will have Carrier Common Line Access Charges applied as set forth in 3.8 following in accordance with the regulations set forth in 3.7(D) following. For purposes of administering this provision:

Resold intrastate inward MIS and MTS-type service(s) shall include collect calls, third number calls and credit card calls where the reseller pays the underlying carrier's service charges; and shall not include interstate minutes of use.

Resold intrastate outward MIS and MTS-type service(s) shall not include collect, third number, credit card or interstate minutes of use.

PUBLIC SERVICE COMMISSION  
OF KENTUCKY  
EFFECTIVE

MAR 3 1992

PURSUANT TO 807 KAR 5:011,  
SECTION 9 (1)

BY: Sharon Keller  
PUBLIC SERVICE COMMISSION MANAGER

Issued: February 7, 1992

Effective: March 3, 1992

Robert E. Aigmon

for

President, Cincinnati, Ohio

ACCESS SERVICE TARIFF  
PSCK No. 2

CINCINNATI BELL TELEPHONE COMPANY

Original Page 92

3. Carrier Common Line Access Service (Cont'd)

3.3 Undertaking of the Telephone Company (Cont'd)

- (C) When access to the local exchange is required to provide a MTS/WATS-type service using a resold Private Line Service, Switched Access Service Rates and Regulations, as set forth in 6. following will apply. Carrier Common Line Access rates and charges as set forth in 3.8 following apply in accordance with the regulations as set forth in 3.7(F) following.
- (D) The Switched Access Service provided by the Telephone Company includes the Switched Access Service provided for both interstate and intrastate communications and the Carrier Common Line Access rates and charges as set forth in 3.8 following apply in accordance with the regulations as set forth in 3.7(E) following.

PUBLIC SERVICE COMMISSION  
OF KENTUCKY  
EFFECTIVE

MAR 3 1992

PURSUANT TO 807 KAR 5:011,  
SECTION 9 (1)

BY: Sharon Helle  
PUBLIC SERVICE COMMISSION MANAGER

Issued: February 7, 1992

Effective: March 3, 1992

*Robert E. Aignone*

President, Cincinnati, Ohio

Vice President - Regulatory Affairs

ACCESS SERVICE TARIFF  
PSCK No. 2

CINCINNATI BELL TELEPHONE COMPANY

Original Page 93

3. Carrier Common Line Access Service (Cont'd)

3.3 Undertaking of the Telephone Company (Cont'd)

- (E) When the IC is provided Operator Trunk-Full Feature Optional Features for sent-paid pay telephone access as set forth in 6. following, the Telephone Company will collect sent-paid monies from pay telephone stations and will remit monies to the IC as set forth in 3.6 following. The Telephone Company will provide message call detail format and bill periods used to determine the monies upon request from the IC.

3.4 Obligations of the Customer

- (A) The Switched Access Service associated with Carrier Common Line Access shall be ordered by the customer under other sections of this tariff .
- (B) The customer facilities at the premises of ordering customer shall provide the necessary on-hook and off-hook supervision.
- (C) Unless the customer reports (1) intrastate use as set forth in (D) following or (2) Feature Group A, B or D Switched Access Service as set forth in (F) following, all Switched Access Service provided to the customer will be subject to Carrier Common Line Access charges.
- (D) When the customer reports interstate and intrastate use of Switched Access Service, the associated Carrier Common Line Access used by the customer for intrastate will be determined as set forth in 3.7(E) following.

PUBLIC SERVICE COMMISSION  
OF KENTUCKY  
EFFECTIVE

MAR 3 1992

PURSUANT TO 807 KAH 5:011,  
SECTION 9 (1)

BY: Sharon J. Miller  
PUBLIC SERVICE COMMISSION MANAGER

Issued February 7, 1992  
Robert E. Sigmon for

Effective: March 3, 1992

President, Cincinnati, Ohio

Vice President - Regulatory Affairs

ACCESS SERVICE TARIFF  
PSCK No. 2

CINCINNATI BELL TELEPHONE COMPANY

Original Page 94

3. Carrier Common Line Access Service (Cont'd)

3.4 Obligations of the Customer (Cont'd)

- (E) When the customer is reselling MTS/WATS and/or MTS/WATS-type service as set forth in 3.3(B) preceding, the customer will be charged the Carrier Common Line Access charges in accordance with the regulations as set forth in 3.7(D) following if the customer or the provider of the MTS/WATS service furnishes documentation of the MTS/WATS usage and/or the customer furnishes documentation of the MTS/WATS-type usage. Such documentation supplied by the customer shall be supplied each month and shall identify the involved resold MTS/WATS and/or MTS/WATS-type services. The monthly period used to determine the minutes of use for resold MTS/WATS and/or MTS/WATS-type service(s) shall be the most recent monthly period for which the customer has received a bill for such resold MTS/WATS and/or MTS/WATS-type service(s). This information shall be delivered to the Telephone Company, at a location specified by the Telephone Company, no later than 15 days after the bill date shown on the resold MTS/WATS and/or MTS/WATS-type service bill. If the required information is not received by the Telephone Company, the previously reported information, as described preceding, will be used for the next two months. For any subsequent month, no allocation or credit will be made until the required documentation is delivered to the Telephone Company by the customer.
- (F) When the customer orders Switched Access Service as set forth in (E) preceding, the Telephone Company or the billing entity may request when resold MTS/WATS is involved, a certified copy of the customer's MTS/WATS usage billing from either the customer or the provider of the MTS/WATS Service and/or when resold MTS/WATS-type service is involved, a certified copy of customer's MTS/WATS-type usage billing from either the customer or the provider of the MTS/WATS-type service. The requests for this billing will relate back no more than 12 months prior to the current billing period.

PUBLIC SERVICE COMMISSION  
OF KENTUCKY  
EFFECTIVE

MAR 3 1992

PURSUANT TO 807 KAH 5:011,  
SECTION 9 (1)

BY: Sharon Kalle  
PUBLIC SERVICE COMMISSION MANAGER

Issued: February 7, 1992

Effective: March 3, 1992

Robert E. Aigmon for President, Cincinnati, Ohio

Vice President - Regulatory Affairs

ACCESS SERVICE TARIFF  
PSCK NO. 2

CINCINNATI BELL TELEPHONE COMPANY

Original Page 95

3. Carrier Common Line Access Service (Cont'd)

3.4 Obligations of the Customer (Cont'd)

(G) Where Operator Trunk-Full Feature Optional Features for sent-paid pay telephone access is provided to the customer and the customer wishes to receive the monies it is due for the monies collected by the Telephone Company from coin pay telephone stations, the customer shall furnish to the Telephone Company, at a location specified by the Telephone Company, the customer message call detail for the customer sent-paid (coin) pay telephone calls in accordance with the Telephone Company Collection Schedule. The customer message call detail furnished shall be in a standard format established by the Telephone Company as set forth in 8.2.1(B)(1)(c) following. If no customer message call detail is received from the customer for each bill period established by the Telephone Company, the Telephone Company will assume there were no customer sent-paid (coin) pay telephone calls for the period. In addition the customer shall furnish a schedule of its charges for sent-paid (coin) calls to the Telephone at a location and date as specified by the Telephone Company. Any change in the customer schedule of charges shall be furnished to the Telephone Company one day after the change becomes effective.

3.5 Payment Arrangements

(A) The Telephone Company will bill the Carrier Common Line Access. The bill day (i.e., the billing date of the bill) in a month for each customer account will be established by the Telephone Company. Payment is due from the customer 31 days after the bill day date (payment date) or by the next bill date (i.e., same date in the following month as the bill date), whichever is the shortest interval, and is payable in immediately available funds. If such payment date is a Saturday, Sunday or Holiday (i.e., New Year's Day, Independence Day, Labor Day, Thanksgiving Day, Christmas Day, the second Tuesday in November, and a day when Washington's Birthday, Memorial Day or Columbus Day is legally observed), payment will be due from the customer as follows:

If such payment date falls on a Sunday or on a Holiday which is observed on a Monday, the payment date shall be the first non-Holiday day following such Sunday or Holiday. If such payment date falls on a Saturday or on a Holiday which is observed on Tuesday, Wednesday, Thursday or Friday, the payment date shall be the last non-Holiday day preceding such Saturday or Holiday.

PURSUANT TO 807 KAR 5:011.  
SECTION 9 (1)

Issued: February 7, 1992

Effective By: Robert E. Aigmon  
PUBLIC SERVICE COMMISSION MANAGER

President, Cincinnati, Ohio

Robert E. Aigmon for

Vice President - Regulatory Affairs

ACCESS SERVICE TARIFF  
PSCK No. 2

CINCINNATI BELL TELEPHONE COMPANY

1st Revised Page 96  
Cancels Original Page 96

3. Carrier Common Line Access Service (Cont'd)

3.5 Payment Arrangements (Cont'd)

- (B) Further, if any portion of the Carrier Common Line Access payment is received by the Telephone Company after the payment date as set forth in the (A) preceding, or if any portion of the Carrier Common Line Access payment is received by the Telephone Company in funds which are not immediately available to the Telephone Company, then a late payment penalty shall be due to the Telephone Company. The late payment penalty shall be the portion of the Carrier Common Line Access payment not received by the payment date times a late factor. The late factor shall be the lesser of:
- (1) the highest interest rate (in decimal value) which may be levied by law for commercial transactions, compounded daily for the number of days from the payment date to and including the date that the customer actually makes the payment to the Telephone Company, or
  - (2) 0.000370 per day, simple interest for the number of days from the payment date to and including the date that the customer actually makes the payment to the Telephone Company. (C)
- (C) In the event a billing dispute concerning a month's Carrier Common Line Access billed to the customer by the Telephone Company is resolved in favor of the Telephone Company, any payments withheld pending settlement of the dispute shall be subject to the late payment penalty set forth in (B) preceding. If the customer disputes the bill on or before the payment date, and pays the undisputed amount on or before the payment date, any late payment charge for the disputed amount will not start until 10 days after the payment date. If the billing dispute is resolved in favor of the customer, no late payment penalty will apply to the disputed amount. In addition, if the customer disputes the billed amount and pays the total amount (i.e. the non-disputed amount and the disputed amount) on or before the payment date and the billing dispute is resolved in the favor of the customer, the customer will receive a credit for a disputed amount penalty from the billing entity if the billing dispute is not resolved within 10 working days following the payment date or the date the customer furnishes to the billing entity documentation to support its claim plus 10 working days, whichever date is the later date. The disputed amount penalty shall be the disputed amount resolved in the customer's favor times a penalty factor.

---

Issued: February 23, 1999

Effective: January 25, 1999

President, Cincinnati, Ohio

ACCESS SERVICE TARIFF  
PSC No. 2

CINCINNATI BELL TELEPHONE COMPANY

1st Revised Page 97  
Cancels Original Page 97

3. Carrier Common Line Access Service (Cont'd)

3.6 Reserved

(C)

(D)

(D)

---

Issued: February 23, 1999

Effective: January 25, 1999

President, Cincinnati, Ohio

ACCESS SERVICE TARIFF  
PSC NO. 2

CINCINNATI BELL TELEPHONE COMPANY

1st Revised Page 98  
Cancels Original Page 98

3. Carrier Common Line Access Service (Cont'd)

3.6 Reserved

(C)

(D)

(D)



ACCESS SERVICE TARIFF  
PSC No. 2

CINCINNATI BELL TELEPHONE COMPANY

1st Revised Page 99  
Cancels Original Page 99

3. Carrier Common Line Access Service (Cont'd)

3.6 Reserved

(C)

(D)

(D)

---

Issued: February 23, 1999

Effective: January 25, 1999

President, Cincinnati, Ohio

ACCESS SERVICE TARIFF  
PSCK No. 2

CINCINNATI BELL TELEPHONE COMPANY

1st Revised Page 100  
Cancels Original Page 100

3. Carrier Common Line Access Service (Cont'd)

3.7 Rate Regulations

- (A) The Access Charges will be billed to each Switched Access Service provided under this tariff in accordance with the regulations as set forth in (F) following except as set forth in (D) and (E) following.
- (B) When access minutes are used to determine Carrier Common Line Charges, they will be accumulated using call detail recorded by Telephone Company equipment and Feature Group C operator and automated operator services systems call detail such as pay telephone sent-paid, operator-DDD perator-person, collect, credit-card, third number and/or other like calls recorded by the customer. The Telephone Company measuring and recording equipment except as set forth in (C) following will be associated with end office or local tandem switching equipment and will record each originating and terminating access minute where answer supervision is received. The accumulated access minutes will be summed on a line by line basis, by line group or end office, whichever type of account is used by the Telephone Company, for each customer and then rounded to the nearest minute. (C)
- (C) When Carrier Common Line Access is provided in association with Feature Group A or Feature Group B Switched Access Service in Telephone Company end offices that are not equipped for measurement capabilities, an assumed average intrastate access minutes will be used to determine the Access Charges. These assume access minutes are as set forth in Section 6.7.8. (C)

ACCESS SERVICE TARIFF  
PSCK No. 2

CINCINNATI BELL TELEPHONE COMPANY

Original Page 101

3. Carrier Common Line Access Service (Cont'd)

3.7 Rate Regulations (Cont'd)

- (D) When the customer is provided an access group to be used in conjunction with the resale of MTS/WATS and/or MTS/WATS-type services as set forth in 3.3(B) preceding, subject to the limitations of Carrier Common Line as set forth in 3.2 preceding, and the billing entity receives the usage information required to calculate the proration of Carrier Common Line as set forth in 3.4(E) preceding, the customer will be billed as set forth in (1) following.

When the customer is provided with more than one access group in a LATA in association with the resale of MTS/WATS and/or MTS/WATS-type services, the resold minutes of use will be apportioned as follows:

The billing entity will apportion the resold outward MTS/WATS and/or MTS/WATS-type services and originating minutes of use for which resale credit applies, among the access groups. Such apportionment will be based on the relationship of the originating usage for each access group to the total originating usage for all access groups in the LATA. For purposes of administering this provision:

Resold outward MTS/WATS and/or MTS/WATS-type services minutes shall be only those attributable to intrastate outward MTS/WATS and/or MTS/WATS-type minutes and shall not include collect, third number, credit card or interstate minutes of use.

The resale credit shall apply for resold outward MTS and MTS-type services and minutes of use, provided Carrier Common Line and Switched Access Charges have been assessed on such services.

PUBLIC SERVICE COMMISSION  
OF KENTUCKY  
EFFECTIVE

MAR 3 1992

PURSUANT TO 807 KAR 5:011,  
SECTION 9 (1)

BY: Cheryl Keller  
PUBLIC SERVICE COMMISSION MANAGER

Issued: February 7, 1992

Effective: March 3, 1992

Robert E. Aigmon for President, Cincinnati, Ohio

ACCESS SERVICE TARIFF  
PSCK No. 2

CINCINNATI BELL TELEPHONE COMPANY

Original Page 102

3. Carrier Common Line Access Service (Cont'd)

3.7 Rate Regulations (Cont'd)

(D) (Cont'd)

The billing entity will apportion the resold inward MTS/WATS and/or MTS/WATS-type services and terminating minutes of use for which resale credit applies, among the access groups. Such apportionment will be based on the relationship of the terminating usage for each access group to the total terminating usage for all access groups in the LATA. For purposes of administering this provision:

Resold inward MTS/WATS and/or MTS/WATS-type services minutes shall be only those attributable to intrastate inward MTS/MTS-type (i.e., collect calls, third number calls, and credit card calls) and WATS/WATS-type and shall not include interstate minutes of use or MTS/MTS-type minutes of use paid for by another party.

The resale credit shall apply for resold inward MTS and MTS-type services and minutes of use, provided Carrier Common Line and Switched Access Charges have been assessed on such services.

In order for the rate regulations to apply as set forth in (1) following, the access groups and the resold MTS/WATS and/or MTS/WATS-type services must be provided in the same state in the same exchange, provided by the same Telephone Company and connected directly or indirectly. For those exchanges that encompass more than one state, the customer shall report the information by state within the exchange.

**PUBLIC SERVICE COMMISSION  
OF KENTUCKY  
EFFECTIVE**

MAR 3 1992

**PURSUANT TO 807 KAR 5:011,  
SECTION 9(1)**

BY: Sharon Keller  
PUBLIC SERVICE COMMISSION MANAGER

Issued: February 7, 1992

Effective: March 3, 1992

Robert E. Aigmon

for

President, Cincinnati, Ohio

VP - President - Regulatory Affairs

ACCESS SERVICE TARIFF  
PSCK No. 2

CINCINNATI BELL TELEPHONE COMPANY

Original Page 103

3. Carrier Common Line Access Service (Cont'd)

3.7 Rate Regulations (Cont'd)

(D) (Cont'd)

Each of the access group arrangements used by the customer in association with the resold MTS/WATS and/or MTS/WATS-type services must be connected either directly or indirectly to the customer designated premises at which the resold MTS/WATS and/or MTS/WATS-type services are terminated. Direct connections are those arrangements where the access groups and resold MTS/WATS and/or MTS/WATS-type services are terminated at the same customer designated premises.

Indirect outward connections are those arrangements where the access groups and the resold outward MTS/WATS and/or MTS/WATS-type services are terminated at different customer designated premises in the same exchange. Such different customer designated premises are connected by facilities that permit a call to flow from access groups to resold MTS/WATS and/or MTS/WATS-type services.

Indirect inward connections are those arrangements where the access groups and resold inward MTS/WATS and/or MTS/WATS-type services are terminated at different customer designated premises in the same exchange. Such different customer designated premises are connected by facilities that permit a call to flow from resold inward MTS/WATS and/or MTS/WATS-type services to access groups.

The adjustments as set forth following will be computed separately for each access group.

PUBLIC SERVICE COMMISSION  
OF KENTUCKY  
EFFECTIVE

MAR 3 1992

PURSUANT TO 807 KAR 5:011,  
SECTION 9 (1)

BY: Sharon Sellen  
PUBLIC SERVICE COMMISSION MANAGER

Issued: February 7, 1992

Effective: March 3, 1992

Robert E. Aigmon for

President, Cincinnati, Ohio

Vice President - Regulatory Affairs

ACCESS SERVICE TARIFF  
PSCK No. 2

CINCINNATI BELL TELEPHONE COMPANY

Original Page 104

3. Carrier Common Line Access Service (Cont'd)

3.7 Rate Regulations (Cont'd)

(D) (Cont'd)

(1) Access Groups - Equal Access Offices

The Access Charge per minute as set forth in 3.8 following will apply to all originating and terminating usage. The minutes billed Carrier Common Line Access Service charges will be the adjusted terminating intrastate access minutes and the adjusted originating intrastate access minutes for such access groups.

The adjusted terminating access minutes will be the terminating intrastate access minutes less the reported resold inward MTS/WATS and/or MTS/WATS-type service minutes of use as set forth in 3.7(D) preceding; but not less than zero. The adjusted originating access minutes will be the originating intrastate access minutes less than reported resold outward MTS/WATS and/or MTS/WATS-type service minutes of use; but not less than zero.

PUBLIC SERVICE COMMISSION  
OF KENTUCKY  
EFFECTIVE

MAR 3 1992

PURSUANT TO 807 KAR 5:011,  
SECTION 9 (1)

BY: Sharon Helle  
PUBLIC SERVICE COMMISSION MANAGER

Issued: February 7, 1992

Effective: March 3, 1992

Robert E. Aigmon for

President, Cincinnati, Ohio

Vice President - Regulatory Affairs

ACCESS SERVICE TARIFF  
PSC No. 2

CINCINNATI BELL TELEPHONE COMPANY

Original Page 105

3. Carrier Common Line Access Service (Cont'd)

3.7 Rate Regulations (Cont'd)

(D) (Cont'd)

- (2) The adjustment as set forth in (1) preceding will be made to the involved customer account no later than either the next bill date, or the one subsequent to that, depending on when the usage report is obtained.
- (3) When the MTS/WATS and/or MTS/WATS-type usage is shown in hours, the number of hours shall be multiplied by **60** to develop the associated MTS/WATS and/or MTS/WATS-type minutes of use. If the MTS/WATS and/or MTS/WATS-type usage is shown in a unit that does not **show** hours or minutes, the customer shall provide a factor to convert the shown units to minutes.
- (4) The adjustment as set forth in (1) preceding will be made to the involved customer account after making the adjustments to the customer account as set forth in (E) following.

PUBLIC SERVICE COMMISSION  
OF KENTUCKY  
EFFECTIVE

MAR 3 1992

PURSUANT TO §07 KAR 5:011,  
SECTION 9(1)

BY: *Joseph J. Halla*  
PUBLIC SERVICE COMMISSION MANAGER

Issued: February 7, 1992

Effective: March 3, 1992

*Robert E. Hignon* for

President, Cincinnati, Ohio

Vice President - Regulatory Affairs

ACCESS SERVICE TARIFF  
PSCK No. 2

CINCINNATI BELL TELEPHONE COMPANY

Original Page 106

3. Carrier Common Line Access Service (Cont'd)

3.7 Rate Regulations (Cont'd)

- (E) When the customer reports interstate and intrastate use of in-service Switched Access Service, the Carrier Common Line Access Charges will be billed only to intrastate Switched Access Service access minutes based on the data reported by the customer as set forth in 2.3.14. The intrastate Switched Access Service access minutes will, after adjustment as set forth in (D) preceding, when necessary, be used to determine the Carrier Common Line Charges as set forth in (F) following.
- (F) After the adjustments as set forth in (D) and (E) preceding have been applied, when necessary, to the Switched Access Service access minutes, the charges for the involved customer account will be determined as follows:

PUBLIC SERVICE COMMISSION  
OF KENTUCKY  
EFFECTIVE

MAR 3 1992

PURSUANT TO 807 KAR 5:011,  
SECTION 9(1)

BY: Glenn Sallee  
PUBLIC SERVICE COMMISSION MANAGER

Issued: February 7, 1992

Effective: March 3, 1992

Robert E. Aigmon

for

President, Cincinnati, Ohio

Vice President - Regulatory Affairs



3. Carrier Common Line Access Service (Cont'd)

3.7 Rate Regulations (Cont'd)

(F) (Cont'd)

- (1) The access minutes for a Feature Group B when utilized for the provision of MTS/WATS service and Feature Group D Switched Access Service will be multiplied by the Access per minute rate as set forth in 3.8 following to determine the charges.
- (2) The access minutes for a Feature Group A or B Switched Access Service will be multiplied by the Access per minute rate as set forth in 3.8 following to determine the charges.
- (3) Carrier Common Line charges shall not be reduced as set forth in 3.3(B) preceding unless Switched Access Charges, as set forth in Section 6 following, are applied to the customer's Switched Access Services.
- (4) Terminating Access, per minute charge(s) apply to:

all terminating access of use;

All originating access minutes of use associated with FGA Access Services where the off-hook supervisory signaling is forwarded by the customer's equipment when the called party answers;

all originating access minutes of use associated with calls placed to 500, 700, 800 and 900 numbers, less those originating access minutes of use associated with calls placed to 500, 700, 800 and 900 numbers for which the customer furnishes for each month report of either the number of calls or minutes or a report of the percent of calls or minutes that terminate in a Switched Access Service that is assessed Carrier Common Line Charges.

(C)

(C)

3. Carrier Common Line Access Service (Cont'd)

3.7 Rate Regulations (Cont'd)

(F) (Cont'd)

(4) (Cont'd)

When the customer makes this report available to the Telephone Company in advance of billing, these minutes of use will be charged on the current bill as originating minutes of use as set forth in (F) following. If a billing dispute arises concerning the customer provided report, the Telephone Company will request the customer to provide the data the customer used to develop the report. The Telephone Company will not request such data more than once a year. The customer shall supply the data within 30 days of the Telephone Company request.

When this report is not available to the Telephone Company until after billing, it shall be used by the Telephone Company to calculate and post a credit to the customer's account. The credit shall be posted to the customer's account within 30 days of receipt of the report. The credit shall be calculated by multiplying the number of access minutes of use, for which a credit is determined to be applicable, times the difference between the terminating and originating Carrier Common Line charges in effect when the calls were completed.

(5) The originating Access, per minute charge(s) apply to

- all originating access minutes of use
- less those originating access minutes of use associated with FGA access Services where the off-hook supervisory signaling is forwarded by the customer's equipment when the called party answers;
- less all originating access minutes of use associated with calls placed to 500, 700, 800 and 900 numbers; (C)

plus all originating access minutes of use associated with calls placed to 500, 700, 800 and 900 numbers for which the customer furnishes for each month a report of either the number of calls or minutes or a report of the percent of calls or minutes that terminate in a Switched Access Service that is assessed Carrier Common Line charges, and for which a corresponding reduction in the number of terminating access minutes of use has been made as set forth in (4) preceding. (C)

ACCESS SERVICE TARIFF  
PSCK No. 2

CINCINNATI BELL TELEPHONE COMPANY

1st Revised Page 109  
Cancels Original Page 109

3. Carrier Common Line Access Service (Cont'd)

3.7 Rate Regulations (Cont'd)

(F) (Cont'd)

(D)

(D)

PUBLIC SERVICE COMMISSION  
OF KENTUCKY  
EFFECTIVE

MAY 23 1995

PURSUANT TO 807 KAR 5.011,  
SECTION 9 (1)

BY: Justin C. Neal  
FOR THE PUBLIC SERVICE COMMISSION

Issued: June 13, 1995

Effective: May 23, 1995

*Deborah A. Nisch* President, Cincinnati, Ohio  
Vice President  
Integrated Corporate Planning for

ACCESS SERVICE TARIFF  
PSCK No. 2

CINCINNATI BELL TELEPHONE COMPANY

3rd Revised Page 110  
Cancels 2nd Revised Page 110

3. Carrier Common Line Service (Cont'd)

3.8 Rates and Charges

The rate for Carrier Common Line Access per Minute is:

|              |             |     |
|--------------|-------------|-----|
| -Terminating | \$0.0327933 | (R) |
| -Originating | \$0.0000000 |     |

4. Reserved

Filed in accordance with Case No. 98-292. Order issued July 26, 1999.

---

Issued: September 22, 1999

Effective: January 25, 1999

President, Cincinnati, Ohio

ACCESS SERVICE TARIFF  
PSCK No. 2

CINCINNATI BELL TELEPHONE COMPANY

1st Revised Page 111  
Cancels Original Page 111

5. Orderinn Options for Switched and Special Access Service

5.1 General

This section sets forth the regulations and order related charges for Access Orders for Switched and Special Access Services. These charges are in addition to other applicable charges as set forth in other sections of this tariff. (C)

An Access Order is an order to provide the customer with Switched Access Service or Special Access Service or to provide changes to existing services. (D)

PUBLIC SERVICE CO.  
EFFECTIVE

MAY 23 1995

PURSUANT TO 807 KAR 5011  
SECTION 9(1) (D)

BY: Jordan C. Neel  
FOR THE PUBLIC SERVICE COMMISSION

5.1.1 Orderinn Conditions

A customer may order any number of services of the same type and between the same premises on a single Access Order. All details for services for a particular order must be identical except multipoint service. All details for multipoint services for a particular order must be identical. (C)

The customer shall provide all information necessary for the Telephone Company to provide and bill for the requested service. In addition to the order information required in 5.2 and 5.4 following, the customer must also provide:

- Customer name and premise address(es).
- Billing name and address (when different from customer name and address).
- Customer contact name(s) and telephone number(s) for the following provisioning activities: order negotiation, order confirmation, interactive design, installation and billing.

Orders for Feature Group A Switched Access Service shall be in lines.

Orders for Feature Group B Switched Access Service shall be in trunks.

Issued: June 13, 1995

Effective: May 23, 1995

*Deborah A. Nisch*

President, Cincinnati, Ohio

Vice President

Integrated Corporate Planning for

ACCESS SERVICE TARIFF  
PSCR No. 2

CINCINNATI BELL TELEPHONE COMPANY

1st Revised Page 112  
Cancels Original Page 112  
BELL SERVICE COMMISSION  
OF KENTUCKY  
FIVE

5. Orderinn Options for Switched and Special Access Service (Cont'd)

5.1 General (Cont'd)

MAY 23 1995

5.1.1 Orderinn Conditions (Cont'd)

PURSUANT TO 807 KAR 5011  
SECTION 9(3)

The order date, which is known as the Application Date, is the date on which the Telephone Company receives a firm commitment and sufficient information from the customer to allow processing of the Access Order. The customer is advised of the Application Date at the time the Telephone Company gives the customer a firm order confirmation. (C)

5.1.2 Provision of Other Services

- (A) In addition to Switched and Special Access Services, other services offered under the provisions of this tariff shall be ordered with an Access Order or as set forth in (B) following. The rates and charges for these other services, as set forth in other sections of this tariff, will apply in addition to the ordering charges set forth in this section and the rates and charges for the Access Service with which they are associated.
- (B) With the agreement of the Telephone Company, other services set forth in (A) preceding may subsequently be added to an Access Order at any time, up to and including the service date for the Access Service. When added subsequently, charges for a design change as set forth in 5.2.2(C) following will apply when an engineering review is required.
- (C) Additional Engineering is not an ordering option, but will be applied to an Access Order when the Telephone Company determines that Additional Engineering is necessary to accommodate a customer request. Additional Engineering will only be required as set forth in 13.1 following. When it is required, the customer will be so notified and will be furnished with a written statement setting forth the justification for the Additional Engineering as well as an estimate of the charges. If the customer agrees to the Additional Engineering, a firm order will be established. If the customer does not want the service or facilities after

Issued: June 13, 1995

Effective: May 23, 1995

*Deborah A. Nisch*  
President, Cincinnati, Ohio  
Vice President  
Integrated Corporate Planning for

ACCESS SERVICE TARIFF  
PSCK No. 2

CINCINNATI BELL TELEPHONE COMPANY

1st Revised Page 113  
Cancels Original Page 113

5. Ordering Options for Switched and Special Access Service (Cont'd)

5.1 General (Cont'd)

5.1.2 Provision of Other Services (Cont'd)

(C) (Cont'd)

PUBLIC SERVICE COMMISSION  
OF KENTUCKY  
EFFECTIVE

MAY 23 1995

PURSUANT TO 807 KAR 5011,  
SECTION 9(1)

BY: Jordan C. Neal  
FOR THE PUBLIC SERVICE COMMISSION

being notified that Additional Engineering of Telephone Company facilities is required, the order will be withdrawn and no charges will apply. Once a firm order has been established, the total charge to the customer for the Additional Engineering may not exceed the estimated amount by more than 10%.

The regulations, rates and charges for Additional Engineering are as set forth in 13.1 following and are in addition to the regulations, rates and charges specified in this section.

5.2 Access Order

An Access Order is used by the Telephone Company to provide a customer Access Service as follows:

- Switched Access Services as set forth in 6. following,
- Special Access Services as set forth in 7. following, and
- Other Services as set forth in 5.1.2 preceding.

When placing an order for Access Service, the customer shall provide, at a minimum, the following information:

- For Feature Group A Switched Access Service, the customer shall specify the number of lines and the first point of switching (i.e., dial tone office), the directionality of the service and the Switched Transport and Local Switching options desired. In addition, the customer shall specify whether the off-hook supervisory signaling for the ordered line(s) is to be provided by the customer's equipment or is to be forwarded by the customer's equipment when the called party answers. The customer shall also specify which lines are to be in multiline hunt group arrangements and which lines are to be provided as single lines. (C)

Issued: June 13, 1995

Effective: May 23, 1995

Deborah A. Nisch  
President, Cincinnati, Ohio  
Vice President  
Integrated Corporate Planning for

ACCESS SERVICE TARIFF  
PSCK No. 2

CINCINNATI BELL TELEPHONE COMPANY

1st Revised Page 114  
Cancels Original Page 114

5. Ordering Options for Switched and Special Access Service (Cont'd)

5.2 Access Order (Cont'd)

- For Feature Group B, C, and D Switched Access Service, the customer shall specify Entrance Facilities and Direct-Trunked Transport Facilities, by channel assignment, e.g., voice grade, or DS1 or DS3 high capacity, and facility assignment between the customer premises and the end office when direct routing to the end office is desired. When routing is desired via an access tandem switch, the customer shall specify Entrance Facilities and Direct-Trunked Transport Facilities (if desired), by channel assignment, e.g., voice grade or, DS1 or DS3 high capacity, and the facility assignment between their premises and the access tandem switch. The customer shall also specify the Switched Transport and Local Switching options desired. ( ; )

When ordering by trunk quantities to an access tandem, the customer must also provide the Telephone Company, when requested, an estimate of the amount of traffic it will generate to and/or from each end office subtending the access tandem to assist the Telephone Company in its own efforts to project facility requirements. The basic traffic type must also be specified using the same categories as described in 6.1.1(G) following, to enable efficient provisioning and billing functions. ( ; )

PUBLIC SERVICE COMMISSION  
OF KENTUCKY  
EFFECTIVE

MAY 23 1995

PURSUANT TO 807 KAR 5.011,  
SECTION 9(1)

BY: Jordan C. Neal  
FOR THE PUBLIC SERVICE COMMISSION

Issued: June 15, 1995

Effective: May 23, 1995

*Deborah L. Reese*

Vice President  
Integrated Corporate Planning for

President, Cincinnati, Ohio



ACCESS SERVICE TARIFF  
PSCK No. 2

CINCINNATI BELL TELEPHONE COMPANY

2nd Revised Page 115  
Cancels 1st Revised Page 115

5. Ordering Options for Switched and Special Access Service (Cont'd)

5.2 Access Order (Cont'd)

- For Feature Group C and D Switched Access Service, etc. (Cont'd)

In addition to the preceding information, the customer shall specify for Feature Group D with CCSAC signaling option a reference to an existing signaling link or reference to a related CCSAC signaling link order. Specification of the level of diversity in its network, as defined in Technical Reference TR-TSV-000905, will be required for CCSAC signaling links and STP Port Terminations. Diversity will be provided as mutually agreed upon availability from the customer's SPOI to the Telephone Company STPs. If appropriate, F.C.C. #39 Special Construction regulation and charges will apply. The customer shall also specify the CCSAC Local Switching options, if any, desired. STP point codes and location identifier codes, trunk circuit identification codes and switch type are required for all interconnecting CCSAC trunks regardless of ordering method. The scheduling of CCSAC trunk conversion orders will be negotiated between the Telephone Company and the customer.

The customer shall work cooperatively with the Telephone Company to determine the number of CCSAC Signaling Links and STP Port Terminations ordered with the Feature Group D CCSAC option, required to handle its signaling traffic.

When a customer orders Switched Access Service in trunks, the customer is responsible to assure that sufficient access facilities have been ordered to handle its traffic.

PUBLIC SERVICE COMMISSION  
OF KENTUCKY  
EFFECTIVE

MAY 23 1995

PURSUANT TO 807 KAR 5011,  
SECTION 9(1)

BY: Jordan C. Neal  
FOR THE PUBLIC SERVICE COMMISSION

Issued: June 13, 1995

Effective: May 23, 1995

*Deborah A. Risch*

President, Cincinnati, Ohio

Vice President  
Integrated Corporate Planning for

ACCESS SERVICE TARIFF  
PSCK No. 2

CINCINNATI BELL TELEPHONE COMPANY

2nd Revised Page 116  
Cancels 1st Revised Page 116

5. Ordering Options for Switched and Special Access Service (Cont'd)

5.2 Access Order (Cont'd)

- For 900 Access Service, the customer shall order in the same manner which is set forth preceding except that customers may request direct connections to only those end offices designated by the Telephone Company as 900 Access Service screening offices. When new NXX Code(s) are to be opened or when existing NXX Code(s) are to be deleted, and such change is to occur coincident with the service date established for the trunk order, the customer shall provide such information when placing the order for service. If the change is to occur absent the requirement for additional capacity, (C) i.e., quantities of trunks, the customer shall notify the Telephone (C) Company of the change as set forth in 6.6.1(D) following.

When a customer requests the Telephone Company to open 900 Access Service NXX Code(s), the order must include the provisioning of all offices of the Telephone Company within the LATA. All 900 number assignments and administration shall be in accordance with the North American Numbering Plan (NANP).

PUBLIC SERVICE COMMISSION  
OF KENTUCKY  
EFFECTIVE

MAY 23 1995

PURSUANT TO 807 KAR 5.011,  
SECTION 9 (1)  
BY: Jordan C. Neal  
FOR THE PUBLIC SERVICE COMMISSION

Issued: June 13, 1995

Effective: May 23, 1995

*Deborah A. Reese*

President, Cincinnati, Ohio

Vice President  
Integrated Corporate Planning for

ACCESS SERVICE TARIFF  
PSCK No. 2

CINCINNATI BELL TELEPHONE COMPANY

1st Revised Page 117  
Cancels Original Page 117

5. Ordering Options for Switched and Special Access Service (Cont'd)

5.2 Access Order (Cont'd)

For Directory Assistance Service, the customer shall specify Entrance Facilities and **Direct-Trunked** Transport Facilities, by channel assignment, e.g., voice grade, or DS1 or DS3 high capacity, and the facility assignment from the customer's premises to the Directory Assistance location. The customer then specifies the Directory Transport options. ( ;)

When routing is desired via an access tandem switch, the customer shall specify Entrance Facilities and Direct Trunked Transport Facilities (if desired), by channel type, e.g., voice grade, DS1 or DS3 high capacity, and the number of trunks between their premises and the access tandem switch. Alternatively, Directory Assistance Service may be associated with Feature Group B, C or D Switched Access Service Facilities. ( ;)

- For all Special Access Services, the customer must specify the customer designated premises or Hubs involved, the channel type, e.g., Voice Grade, High Capacity, etc., the channel interface technical specifications package and options desired. For multi-point services, the channel interface at each premises may, at the request of the customer, be different but all such interfaces shall be compatible.

PUBLIC SERVICE COMMISSION  
OF KENTUCKY  
EFFECTIVE

MAY 23 1995

PURSUANT TO 807 KAR 5.011,  
SECTION 9(1)

BY: Jordan C. Neel  
FOR THE PUBLIC SERVICE COMMISSION

Issued: June 13, 1995

Effective: May 23, 1995

Deborah A. Hisek  
Vice President  
Integrated Corporate Planning for

President, Cincinnati, Ohio

ACCESS SERVICE TARIFF  
PSCK No. 2

CINCINNATI BELL TELEPHONE COMPANY

1st Revised Page 118  
Cancels Original Page 118

5. Ordering Options for Switched and Special Access Service (Cont'd)

5.2 Access Order (Cont'd)

**For** WATS Access Line Service the customer must also specify the type of calling (i.e., originating only, terminating only or two way) for which the service is to be provided. Additionally, when optional screening functions requested by the customer are not provided at the end office which serves the customer's originating or terminating premises, the Telephone Company will provide the service to the nearest WATS serving end office where capacity exists. In these circumstances, the customer will be **so** notified and the order will be changed to designate the appropriate end office. No charge will apply for this change.

Where the Special Access Service is exempt from the Special Access Surcharge as set forth in Section 7.4.2 following, the customer shall furnish with the order the certification as set forth in that section.

5.2.1 Access Order Service Date Intervals

Access Service is provided with one of the following Service Date Intervals:

- Standard Interval
- Negotiated Interval

To the extent the Access Service can be made available with reasonable effort, the Telephone Company will provide the Access Service in accordance with the customer's requested interval, subject to the following conditions:

(A) Standard Interval

A schedule of Standard Intervals applicable for Switched and Special Access Services will be provided to customers. (T)  
The schedule specifies the services and quantities that can be provided within Standard Intervals.

Access Services provided in a Standard Interval will be installed during Telephone Company business days. If a customer requests that installation be done outside of normally scheduled working hours, and the Telephone Company agrees to this request, the customer will be subject to applicable Additional Labor Charges as set forth in 13.2.6 following.

PUBLIC SERVICE COMMISSION  
OF KENTUCKY  
EFFECTIVE  
OCT 26 1992

Issued: September 24, 1992

PURSUANT TO 807 KAR 5:011,  
SECTION 9(1)  
Effective: October 26, 1992  
BY: Gregg Deller  
PUBLIC SERVICE COMMISSION MANAGER

*Robert E. Long* President, Cincinnati, Ohio

Vice President - Regulatory Affairs

ACCESS SERVICE TARIFF  
PSCK No. 2

CINCINNATI BELL TELEPHONE COMPANY

1st Revised Page 119  
Cancels Original Page 119

5. Ordering Options for Switched and Special Access Service (Cont'd)

5.2 Access Order (Cont'd)

5.2.1 Access Order Service Date Intervals (Cont'd)

(B) Negotiated Interval

The Telephone Company will negotiate a service date interval with the customer when:

- (1) There is no Standard Interval for the service,
- (2) The quantity of Access Services ordered exceeds the quantities specified in the Schedule of Standard Intervals, or
- (3) The customer requests a service date beyond the applicable Standard Interval service date.
- (4) The access service is jointly provided by one or more Local Exchange Carriers within the same LATA.

(T)  
(T)

The Telephone Company will offer a service date based on the type and quantity of Access Services the customer has requested. The Negotiated Interval may not exceed by more than six months the Standard Interval Service date, or, when there is no Standard Interval, the Telephone Company offered service date.

All part-time Program Audio services are provided with a Negotiated Interval. Each service is subject to a service inquiry. A service inquiry is a request to the Telephone Company to determine if facilities exist to provide the service ordered and to determine the service date on which service can be provided to the customer.

All services for which rates are applied on an individual case basis are provided with a Negotiated Interval.

- (C) Certain Telephone Company critical dates are associated with an Access Order provisioning interval, whether standard or negotiated. These dates are as follows.

PUBLIC SERVICE COMMISSION  
OF KENTUCKY  
EFFECTIVE

OCT 26 1992

PURSUANT TO 807 KAR 5:011.

Issued: September 24, 1992

Effective: October 28, 1992

*Robert E. Aigmon* for President, Cincinnati, Ohio

BY: *George Haller*  
PUBLIC SERVICE COMMISSION MANAGER

Vice President - Regulatory Affairs

ACCESS SERVICE TARIFF  
PSCK No. 2

CINCINNATI BELL TELEPHONE COMPANY

1st Revised Page 120  
Cancels Original Page 120  
PUBLIC SERVICE COMMISSION  
OF KENTUCKY  
EFFECTIVE

5. Ordering Options for Switched and Special Access Service (Cont'd)

5.2 Access Order (Cont'd)

MAY 23 1995

5.2.1 Access Order Service Date Intervals (Cont'd)

PURSUANT TO 807 KAR 5011,  
SECTION 9(1)

(C) (Cont'd)

BY: Jordan C. Neel  
FOR THE PUBLIC SERVICE COMMISSION

- Application Date (APP): The date on which the Telephone Company receives complete and accurate information from the customer which allows the Telephone Company to initiate its ordering process for the Access Order. This is also the order date. (C)
- Scheduled Issue Date (SID): The date that the order is to be entered in the Telephone Company's order distribution system.
- Design Layout Report Date (DLRD): The date the Design Layout Report (DLR) is to be forwarded to the customer.
- Confirming Design Layout Report Date (CDLRD): The date the Design Layout Report (DLR) is to be confirmed by the customer,
- Records Issue Date (RID): The date that all design and assignment information is to be sent to the central office and installation forces.
- Wired and Office Tested Date (WOT): The date by which all intraoffice wiring is to be completed, all plug-ins optioned, aligned, and frame continuity established, and the interoffice facilities, if applicable, tested. In addition, switching equipment, including translation loading, is to be installed and tested.
- Plant Test Date (PTD): The date on which overall testing of the service is to be started.
- Service Date (DD): The date on which service is to be made available to the customer. This is sometimes referred to as the Due Date.

Issued: June 13, 1995

Effective: May 23, 1995

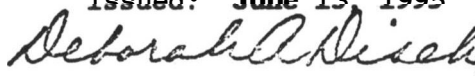
  
Deborah A. Nisch, President, Cincinnati, Ohio  
Vice President  
Integrated Corporate Planning for

ACCESS SERVICE TARIFF  
PSCK No. 2

CINCINNATI BELL TELEPHONE COMPANY

2nd Revised Page 121  
Cancels 1st Revised Page 121

5. Ordering Options for Switched and Special Access Service (Cont'd)

5.2 Access Order (Cont'd)

5.2.2 Access Order Modifications

The customer may request a modification of its Access Order at any time prior to notification by the Telephone Company that service is available for the customer's use. The Telephone Company will make every effort to accommodate a requested modification when it is able to do so with the normal work force assigned to complete such an order within normal business hours. If the modification cannot be made with the normal work force during normal business hours, the Telephone Company will notify the customer. If the customer still desires the Access Order modification, the Telephone Company will schedule a new service date. All charges for Access Order modifications will apply on a per occurrence basis.

Any increase in the number of Special Access Service channels or Switched Access Service lines, trunks, or CCSAC Signaling **Links** or **STP Port Terminations** will be treated as a new Access Order (for the increased amount only). (C)

PUBLIC SERVICE COMMISSION  
OF KENTUCKY  
EFFECTIVE

MAY 23 1995

PURSUANT TO 807 KAR 5:011,  
SECTION 9(1)

BY: Jordan C. Neal  
FOR THE PUBLIC SERVICE COMMISSION

Issued: June 12, 1995

Effective: May 23, 1995

*Deborah D. Dusch*

President, Cincinnati, Ohio

Vice President  
Integrated Corporate Planning for

ACCESS SERVICE TARIFF  
PSCK No. 2

CINCINNATI BELL TELEPHONE COMPANY

2nd Revised Page 122  
Cancels 1st Revised Page 122

5. Ordering Options for Switched and Special Access Service (Cont'd)

5.2 Access Order (Cont'd)

5.2.2 Access Order Modifications (Cont'd)

If order modifications are necessary to satisfy the transmission performance for a Special Access Service ordered by a customer, these changes will be made without order modification charges being incurred by the customer.

(A) Service Date Change Charge

Access Order service dates for the installation of new services or rearrangements of existing services may be changed, but the new service date may not exceed the original service date by more than 30 calendar days. When, for any reason, the customer indicates that service cannot be accepted for a period not to exceed 90 calendar days, and the Telephone Company accordingly delays the start of service, a Service Date Change Charge will apply. If the customer requested service date is more than 30 calendar days after the original service date, the order may be canceled by the Telephone Company and reissued with the appropriate cancellation charges applied unless the customer indicates that billing for the service is to commence as set forth in 5.2.3 (A) following.

PUBLIC SERVICE COMMISSION  
OF KENTUCKY  
EFFECTIVE

MAY 23 1995

PURSUANT TO 807 KAR 5.011,  
SECTION 9(1)

BY: Jordan C. Neel  
FOR THE PUBLIC SERVICE COMMISSION

A new service date may be established that is prior to the original Standard or Negotiated Interval service date if the Telephone Company determines it can accommodate the customer's request without delaying service dates for orders of other customers. If the service date is changed to an earlier date, the customer will be notified by the Telephone Company that Expedited Order Charges as set forth in (D) following will apply. Such charges will apply in addition to the Service Date Change Charge.

A Service Date Change Charge will apply, on a per order per occurrence basis, for each service date changed. The applicable charge is:

|  | <u>USOC</u> | <u>Charge</u> |
|--|-------------|---------------|
| Service Date Change Charge,<br>per order | OMC         | \$67.22(I)    |

Issued: ~~June 13, 1995~~

Effective: ~~May 23, 1995~~

Deborah Risch  
Vice President  
Integrated Corporate Planning for

President, Cincinnati, Ohio



ACCESS SERVICE TARIFF  
PSCK No. 2

CINCINNATI BELL TELEPHONE COMPANY

2nd Revised Page 123  
Cancels 1st Revised Page 123

5. Ordering Options for Switched and Special Access Service (Cont'd)

5.2 Access Order (Cont'd)

5.2.2 Access Order Modifications (Cont'd)

(B) Partial Cancellation Charge

Any decrease in the number of ordered Special Access Service channels or Switched Access Service lines, trunks, channels, CCSAC Signaling Links or STP Port Terminations signaling connections will be treated as a partial cancellation and the charges as set forth in 5.2.3(B) following will apply.

(C)  
(C)

(C) Design Change Charge

The customer may request a design change to the service ordered. A design change is any change to an Access Order which requires engineering review. An engineering review is a review by Telephone Company personnel, of the service ordered and the requested changes to determine what changes in the design, if any, are necessary to meet the changes requested by the customer. Design changes include such things as the addition or deletion of optional features or functions or a change in the type of Transport Termination (Switched Access only), type of channel interface, type of Interface Group or technical specification package. Design changes do not include a change of customer premises, end user premises, end office switch, Feature Group type or Special Access Service channel type. Changes of this nature will require the issuance of a new order and the cancellation of the original order with appropriate cancellation charges applied.

PUBLIC SERVICE COMMISSION  
OF KENTUCKY  
EFFECTIVE

MAY 23 1995

PURSUANT TO 807 KAR 5:011,  
SECTION 9(1)

BY: Jordan C. Neal  
FOR THE PUBLIC SERVICE COMMISSION

Issued: June 13, 1995  
Deborah K. Kish

Effective: **May 23, 1995**

Vice President  
Integrated Corporate Planning for

President, Cincinnati, Ohio

ACCESS SERVICE TARIFF  
PSC No. 2

CINCINNATI BELL TELEPHONE COMPANY

2nd Revised Page 124  
Cancels 1st Revised Page 124  
PUBLIC SERVICE COMMISSION  
OF KENTUCKY  
EFFECTIVE

5. Ordering Options for Switched and Special Access Service (Cont'd)

5.2 Access Order (Cont'd)

MAY 23 1995

5.2.2 Access Order Modifications (Cont'd)

PURSUANT TO 807 KAR 5.011.  
SECTION 9 (1)

(C) Design Change Charge (Cont'd)

BY: Jordan C. Neal  
FOR THE PUBLIC SERVICE COMMISSION

The Telephone Company will review the requested change, notify the customer whether the change is a design change, if it can be accommodated and if a new service date is required. If the customer authorizes the Telephone Company to proceed with the design change, a Design Change Charge will apply. The Design Change Charge will apply on a per order per occurrence basis, for each order requiring a design change. The applicable charge is:

|                                    | <u>USOC</u> | <u>Rate</u> |
|------------------------------------|-------------|-------------|
| Design Change Charge,<br>per order | H28         | \$67.22(I)  |

If a change of service date is required, the Service Date Change Charge as set forth in (A) preceding will also apply.

(D) Expedited Order Charge

When placing an Access Order for service(s) for which standard intervals exist, a customer may request a service date that is prior to the standard interval service date. A customer may also request an earlier service date on a pending standard or negotiated interval Access Order. If the Telephone Company agrees to provide service on an expedited basis, subject to limitations of personnel and material, an Expedited Order Charge will apply.

If the Telephone Company is subsequently unable to meet an agreed upon expedited service date, no Expedited Order Charge will apply unless the missed service date was caused by the customer.

Issued: June 13, 1995

Effective: May 23, 1995

Deborah A. Nisch  
President, Cincinnati, Ohio  
Vice President  
Integrated Corporate Planning for

ACCESS SERVICE TARIFF  
PSCK No. 2

CINCINNATI BELL TELEPHONE COMPANY

Original Page 125

5. Ordering Options for Switched and Special Access Service (Cont'd)

5.2 Access Order (Cont'd)

5.2.2 Access Order Modifications (Cont'd)

(D) Expedited Order Charge (Cont'd)

To calculate the additional labor charges, the Telephone Company will, upon authorization from the customer to incur the additional labor charges, keep track of the additional labor hours used to meet the request of the customer and will bill the customer at the applicable Additional Labor charges as set forth in 13.2.6(A) following.

The extraordinary costs which may be involved, will be billed to the customer at charges equivalent to the estimated cost to be incurred.

When the request for expediting occurs subsequent to the application date of the Access Order, a Service Date Change Charge as set forth in (A) preceding also applies.

**PUBLIC SERVICE COMMISSION  
OF KENTUCKY  
EFFECTIVE**

MAR 3 1992

**PURSUANT TO 807 KAR 5:011,  
SECTION 9 (1)**

BY: *Sharon Staller*  
PUBLIC SERVICE COMMISSION MANAGER

Issued: February 7, 1992

Effective: March 3, 1992

*Robert E. Aigmon* for President, Cincinnati, Ohio

Vice President - Regulatory Affairs

ACCESS SERVICE TARIFF  
PSC No. 2

CINCINNATI BELL TELEPHONE COMPANY

Original Page 126

5. Ordering Options for Switched and Special Access Service (Cont'd)

5.2 Access Order (Cont'd)

5.2.3 Cancellation of an Access Order

(A) A customer may cancel an Access Order for the installation of service at any time prior to notification by the Telephone Company that service is available for the customer's use, subject to charges specified in (B) following. The cancellation date is the date the Telephone Company receives written or verbal notice from the customer that the order is to be cancelled. The verbal notice must be followed by written confirmation within 10 days. If a customer or a customer's end user is unable to accept Access Service within **30** calendar days after the original customer requested service date, the customer has the choice of the following options:

- The Access Order shall be cancelled and charges set forth in (B) following will apply, or
- Billing for the service will commence.

In any event, the cancellation date or the date billing is to commence (depending on which option is selected by the customer) shall be the 31st day beyond the original service date of the Access Order.

**PUBLIC SERVICE COMMISSION  
OF KENTUCKY  
EFFECTIVE**

MAR 3 1992

PURSUANT TO 807 KAR 5:011,  
SECTION 9 (1)

BY: Sharon L. Latta  
PUBLIC SERVICE COMMISSION MANAGER

Issued: February 7, 1992

Effective: March 3, 1992

Robert E. Aigmon for President, Cincinnati, Ohio

Vice President - Regulatory Affairs

ACCESS SERVICE TARIFF  
PSCK No. 2

CINCINNATI BELL TELEPHONE COMPANY

Original Page 127

5. Ordering Options for Switched and Special Access Service (Cont'd)

5.2 Access Order (Cont'd)

5.2.3 Cancellation of an Access Order (Cont'd)

- (B) When a customer cancels an Access Order for the installation of service, a Cancellation Charge will apply as follows:
- (1) Installation of Switched or Special Access, facilities is considered to have started when the Telephone Company incurs any cost in connection therewith or in preparation thereof which would not otherwise have been incurred.
  - (2) When the customer cancels an Access Order prior to the start of installation of access facilities, no charges shall apply.
  - (3) When installation of access facilities has been started prior to the cancellation, the charges specified in (a) or (b) following, whichever is lower, shall apply.
    - (a) A charge equal to the costs incurred in such installation, less estimated net salvage. Such charge is determined as detailed in (4) following.
    - (b) The charge for the minimum period of Switched or Special Access Service ordered by the customer.
  - (4) Charges applicable as specified in (3)(a) preceding include the nonrecoverable cost of equipment and material ordered, provided or used, plus the nonrecoverable cost of installation and removal including the costs of engineering, labor, supervision, transportation, rights-of-way and other associated costs.
- (C) When a customer cancels an order for the discontinued service, no charges apply for the cancellation.

PUBLIC SERVICE COMMISSION  
OF KENTUCKY  
EFFECTIVE

MAR 3 1992

PURSUANT TO 807 KAR 5:011,  
SECTION 9 (1)

Issued: February 7, 1992

Effective: March 3, 1992  
PUBLIC SERVICE COMMISSION MANAGER

*Robert E. Aiguon* for  
President, Cincinnati, Ohio

wise President - Regulatory Affairs

ACCESS SERVICE TARIFF  
PSCK No. 2

CINCINNATI BELL TELEPHONE COMPANY

1st Revised Page 128  
Cancels Original Page 128

5. Ordering Options for Switched and Special Access Service (Cont'd)

5.2 Access Order (Cont'd)

5.2.3 Cancellation of an Access Order (Cont'd)

- (D) If the Telephone Company misses a service date by more than 30 days due to circumstances over which it has direct control (excluding, e.g., acts of God, governmental requirements, work stoppages and civil commotions), the customer ~~may~~ cancel the Access Order without incurring cancellation charges.

5.2.4 Selection Of Facilities For Access Orders

- (A) **When** a customer places an Access Order, it ~~may~~ choose to utilize facilities it previously purchased as a facility to a hub. If the customer has a high capacity interface for use with Switched Access Service Interoffice Groups 6 and 9, or has a Switched **Transport** or Special Access Service facility purchased to a Hub, the customer must request that specific channels be used to implement the Access Order.

(C)  
|  
(C)

PUBLIC SERVICE COMMISSION  
OF KENTUCKY  
EFFECTIVE

MAY 23 1995

PURSUANT TO 807 KAR 5:011,  
SECTION 9(1)

BY: Jordan C. Neal  
FOR THE PUBLIC SERVICE COMMISSION

Issued: June 13, 1995

Effective: May 23, 1995

*Deborah A. Nisch*

President, Cincinnati, Ohio

Vice President  
Integrated Corporate Planning for

ACCESS SERVICE TARIFF  
PSCK No. 2

CINCINNATI BELL TELEPHONE COMPANY

2nd Revised Page 129  
Cancels 1st Revised Page 129

5. Ordering Options for Switched and Special Access Service (Cont'd)

5.2 Access Order (Cont'd)

5.2.4 Selection Of Facilities For Access Orders (Cont'd)

- (B) For all other Access Orders, the option to request a specific transmission path or channel is not provided except as provided for under Special Facilities Routing as set forth in 11. following.

5.2.5 Minimum Period

- (A) Except as set forth in (C), 7.4.9 and 9.4(A) following, the minimum period for which Access Service is provided and for which charges are applicable, is one month. (D)
- (B)
- (C) The minimum period for part-time Program Audio Special Access Services is one day even though the service will be provided only for the duration of the event specified on the order (e.g., one-half hour, two hours, five hours, etc.).
- (D) Service Rearrangements as set forth in 6.7.1(C)(2) and 7.4.1 (C)(3) following for Switched and Special Access Services respectively, may be made without a change in minimum period requirements.
- (E) Changes other than those identified in 6.7.1(C)(2) or 7.4.1 (C)(3) following will be treated as a discontinuance of the existing service and an installation of a new service. All associated nonrecurring charges will apply for the new service. A new minimum period will be established for the new service. The customer will also remain responsible for all outstanding minimum period obligations associated with the disconnected service

The changes listed below are those which will be treated as a discontinuance and installation of service and for which a new minimum period is to be established.

ACCESS SERVICE TARIFF  
PSCK No. 2

CINCINNATI BELL TELEPHONE COMPANY

1st Revised Page 130  
Cancels Original Page 130

5. Ordering Options for Switched and Special Access Service (Cont'd)

5.2 Access Order (Cont'd)

5.2.5 Minimum Period (Cont'd)

(E) (Cont'd)

- (1) A change of customer of record (i.e., Access Service is provided to and billed to a different entity)
- (2) A move to a different building as set forth in 6.7.7 (T) or 7.4.5(B) following.
- (3) A change in type of service (i.e., Switched Access to Special Access, one type of Special Access to another, or one type of Switched Access Feature Group to another except as set forth in 6.7.6 following)
- (4) A change in the type of Special Access Service Channel Termination or Switched Access Service Entrance Facility (C)
- (5) A change in switched Access Service or Directory Assistance Service Interface Group (C)
- (6) Change in Switched Access Service traffic type
- (7) Change from two-point to multipoint Special Access Service or from multipoint to two-point Special Access Service.

- (F) When Access Service is disconnected prior to the expiration of the Minimum Period, the customer is obligated for payment of a Minimum Period Charge as set forth in 5.2.6 following. When Access Service is disconnected after the expiration of the Minimum Period, billing for the service will be performed in accordance with the provisions set forth in 2.4.1(D) preceding.

PUBLIC SERVICE COMMISSION  
OF KENTUCKY  
EFFECTIVE

MAY 23 1995

PURSUANT TO 807 KAR 5:011,  
SECTION 9(1)

BY: Jordan C. Neel  
FOR THE PUBLIC SERVICE COMMISSION

Issued: ~~June 13, 1995~~

*Deborah Hesch*  
Vice President  
Integrated Corporate Planning for

President, Cincinnati, Ohio

Effective: **May 23, 1995**



CINCINNATI BELL TELEPHONE COMPANY

1st Revised Page 131  
Cancels Original Page 131

5. Ordering Options for Switched and Special Access Service (Cont'd)

5.2 Access Order (Cont'd)

5.2.6 Minimum Period Charges

The Minimum Period Charge is the charge a customer is obligated to pay for service if the customer elects to disconnect service prior to the expiration of the Minimum Period.

PUBLIC SERVICE COMMISSION  
OF KENTUCKY  
EFFECTIVE

MAY 23 1995

PURSUANT TO 807 KAR 5:011,  
SECTION 9 (1)

BY: Jordan C. Neal  
FOR THE PUBLIC SERVICE COMMISSION (B)

(A) The Minimum Period Charge for services provided with a one month minimum period will be determined as follows:

- (1) For Switched Access Service, the charge is equal to the applicable minimum monthly charge set forth in 6.7.4 following. (T)
- (2) For Special Access Service, the charge is the applicable monthly rates for the service as set forth in 7.5 following.

(D)  
|  
(D)

(C) The Minimum Period Charge for part-time Program Audio Special Access Services is the applicable daily rate for the service as set forth in 7.5 following.

(D) The Minimum Period Charge for service provided under the Payment Plans for MercNET 45 High Capacity Services will be determined as set forth in 7.4.9 following.

Should billing for a service which is disconnected prior to the expiration of the Minimum Period cover multiple billing cycles, the bill reflecting the disconnect of service will be adjusted to account for that portion of the Minimum Period Charge previously billed to the customer. In no event shall the total recurring charge billed to the customer for such service exceed the applicable Minimum Period Charge.

All applicable nonrecurring charges associated with the provision of service will be billed in addition to the Minimum Period Charge. Such nonrecurring charges include the nonrecurring charge for the installation of service and/or optional features, Service Order Modification Charges, Additional Engineering and Labor Charges, if any, etc.

Deborah B. Smith  
Issued: June 13, 1995

Effective: May 23, 1995

Vice President  
Integrated Corporate Planning for President, Cincinnati, Ohio

ACCESS SERVICE TARIFF  
PSCK No. 2

CINCINNATI BELL TELEPHONE COMPANY

Original Page 132

5. Ordering Options for Switched and Special Access Service (Cont'd)

5.2 Access Order (Cont'd)

5.2.7 Shared Use Facilities

Shared Use (i.e., Switched and Special Access Services provided over the same analog or digital high capacity facilities) is allowed. Shared use facilities to a Hub will be ordered and provided as Special Access Service. While shared use is allowed, individual services utilizing these facilities must be ordered either as Switched Access Service or Special Access Service. When placing the order for the individual service(s), the customer must specify a channel assignment for each service ordered.

5.2.8 Switched Access Service To Cellular Interconnections

For Feature Groups B and D Switched Access Service provided to a Mobile Telephone Switching Office (MTSO) directly interconnected to a Telephone Company access tandem office, the customer shall provide information to the Telephone Company indicating the NXX code(s) to be accessed.

PUBLIC SERVICE COMMISSION  
OF KENTUCKY  
EFFECTIVE

MAR 3 1992

PURSUANT TO 807 KAR 5:011,  
SECTION 9 (1)

BY:   
PUBLIC SERVICE COMMISSION MANAGER

Issued: February 7, 1992

Effective: March 3, 1992

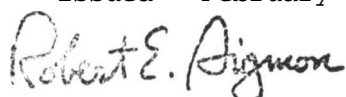
 for President, Cincinnati, Ohio

Vice President - Regulatory Affairs

ACCESS SERVICE TARIFF  
PSC No. 2

CINCINNATI BELL TELEPHONE COMPANY

1st Revised Page 133  
Cancels Original Page 133

5. Ordering Options for Switched and Special Access Service (Cont'd)

5.3 Available Inventory

Available inventory is limited and does not include facilities previously ordered. The Telephone company will make every reasonable effort to maintain sufficient available inventory to provide Access Service in accordance with customers' requested service date intervals. To the extent that service can be provided, Access Orders will be satisfied from available inventory.

(D)  
|  
(D)

PUBLIC SERVICE COMMISSION  
OF KENTUCKY  
EFFECTIVE

MAY 23 1995

PURSUANT TO 807 KAR 5-011,  
SECTION 9(1)

BY: Jordan C. Keel  
FOR THE PUBLIC SERVICE COMMISSION

Issued: June 13, 1995

Effective: **May 23, 1995**

Deborah A. Nisch  
President, Cincinnati, Ohio  
Vice President  
Integrated Corporate Planning for

ACCESS SERVICE TARIFF  
PSCK No. 2

CINCINNATI BELL TELEPHONE COMPANY

1st Revised Page 134  
Cancels Original Page 134

5. Ordering Options for Switched and Special Access Service (Cont'd)

5.4

(D)

This page and the following pages have been deleted and are available for future use:

1st Revised Page 135  
1st Revised Page 136  
1st Revised Page 137  
1st Revised Page 138  
1st Revised Page 139  
2nd Revised Page 140  
1st Revised Page 141  
1st Revised Page 142  
1st Revised Page 143  
1st Revised Page 144  
1st Revised Page 145  
1st Revised Page 146  
1st Revised Page 147  
1st Revised Page 148

PUBLIC SERVICE COMMISSION  
OF KENTUCKY  
EFFECTIVE

MAY 23 1995

PURSUANT TO 807 KAR 5:011,  
SECTION 9(1)

BY: Jordan C. Neel  
FOR THE PUBLIC SERVICE COMMISSION

(D)

Issued: June 13, 1995

Effective: May 23, 1995

*Deborah A. Wisch* resident, Cincinnati, Ohio

Vice President  
Integrated Corporate Planning for

ACCESS SERVICE TARIFF  
PSCK No. 2

CINCINNATI BELL TELEPHONE COMPANY

2nd Revised Page 149  
Cancels 1st Revised Page 149

5. Ordering Options for Switched and Special Access Service (Cont'd)

5.5 Access Order Standard Intervals

The Standard Intervals, as set forth following, will be used for all Access Orders for Special Access Services of the same channel type with the same requested service date and all Switched Access Services with the same type Interface Group, channel type, and/or Feature Group with the same requested service date. (C)

The Standard Intervals are subject to the following conditions:

- The Standard Interval is the sum of the intervals from (1) the Application Date (APP) to the Design Layout Report Date (DLRD) and, (2) the Confirming Design Layout Report Date (CDLRD) to the Service Date (DD). These dates are defined in 5.2.1(C) preceding.
- The period between the Design Layout Report Date (DLRD) and the Confirming Design Layout Report Date (CDLRD) is controlled by the customer, but is agreed upon by the customer and the Telephone Company prior to the Application Date. This period is limited to a maximum of 20 days.
- Service dates for items and services not included in the Schedule of Standard Intervals will be negotiated.
- Regardless of how many separate orders are placed at the same time for service between the same locations and with the same service date, if 25 or more services of the same type are involved as described preceding, the interval will be considered as negotiable even though separate orders reflect quantities that qualify as Standard Intervals.
- When the provision of Switched Access Service requires the installation of a new high capacity premises interface of the type specified for Interface Groups 6 through 9, the interval will be considered negotiable. (C)

PUBLIC SERVICE COMMISSION  
OF KENTUCKY  
EFFECTIVE

MAY 23 1995

PURSUANT TO 807 KAR 5911,  
SECTION 9(1)

BY: Jordan C. Neal  
FOR THE PUBLIC SERVICE COMMISSION

Issued: June 13, 1995

Effective: May 23, 1995

Deborah A. Nichols, Cincinnati, Ohio  
Vice President  
Integrated Corporate Planning for

ACCESS SERVICE TARIFF  
PSCK No. 2

CINCINNATI BELL TELEPHONE COMPANY

1st Revised Page 150  
Cancels Original Page 150

5. Ordering Options for Switched and Special Access Service (Cont'd)

5.5 Access Order Standard Intervals (Cont'd)

5.5.1 (Reserved)

(D)

PUBLIC SERVICE COMMISSION  
OF KENTUCKY  
EFFECTIVE

OCT 26 1992

PURSUANT TO 807 KAR 5:011  
SECTION 9 (1)

Issued: September 24, 1992

Effective: October 26, 1992  
PUBLIC SERVICE COMMISSION MANAGER

*Robert E. Aignone* for President, Cincinnati, Ohio

Vice President - Regulatory Affairs

ACCESS SERVICE TARIFF  
PSCK No. 2

CINCINNATI BELL TELEPHONE COMPANY

1st Revised Page 151  
Cancels Original Page 151

5. Ordering Options for Switched and Special Access Service (Cont'd)

5.5 Access Order Standard Intervals (Cont'd)

5.5.1 (Reserved)

(D)

(D)

PUBLIC SERVICE COMMISSION  
OF KENTUCKY  
EFFECTIVE

OCT 26 1992

PURSUANT TO 807 KAR 5:01 1,  
SECTION 9 (1)

Issued: September 24, 1992

Effective: October 28, 1992

BY: *[Signature]*  
PUBLIC SERVICE COMMISSION MANAGER

*Robert E. Sigmund* for President, Cincinnati, Ohio

Vice President - Regulatory Affairs

ACCESS SERVICE TARIFF  
PSCK No. 2

CINCINNATI BELL TELEPHONE COMPANY

1st Revised Page 152  
Cancels Original Page 152

5. Ordering Options for Switched and Special Access Service (Cont'd)

5.5 Access Order Standard Intervals (Cont'd)

5.5.1 (Reserved) (Cont'd)

(D)

(D)

PUBLIC SERVICE COMMISSION  
OF KENTUCKY  
EFFECTIVE

OCT 26 1992

Issued: September 24, 1992

PURSUANT TO 807 KAR 5:011.  
Effective ~~September~~ October 26, 1992  
SECTION 5

*Robert E. Sigmon* for President, Cincinnati, Ohio  
Vice President - Regulatory Affairs

BY: *Clay Walker*  
PUBLIC SERVICE COMMISSION MANAGER



ACCESS SERVICE TARIFF  
PSCK No. 2

CINCINNATI BELL TELEPHONE COMPANY

1st Revised Page 153  
Cancels Original Page 153

5. Ordering Options for Switched and Special Access Service (Cont'd)

5.5 Access Order Standard Intervals (Cont'd)

5.5.1 (Reserved) (Cont'd)

PUBLIC SERVICE COMMISSION  
OF KENTUCKY  
EFFECTIVE

OCT 26 1992

PURSUANT TO 807 KAH 5:011.

Issued: September 24, 1992

Effective: ~~September 16,~~ SECTION 911, 1992

BY: Cheryl Walker  
PUBLIC SERVICE COMMISSION MANAGER

Robert E. Signor for President, Cincinnati, Ohio

Vice President - Regulatory Affairs

ACCESS SERVICE TARIFF  
PSCK No. 2

CINCINNATI BELL TELEPHONE COMPANY

1st Revised Page 154  
Cancels Original Page 154

5. Ordering Options for Switched and Special Access Service (Cont'd)

5.5 Access Order Standard Intervals (Cont'd)

5.5.2 (Reserved)

(D)

PUBLIC SERVICE COMMISSION  
OF KENTUCKY  
EFFECTIVE

(D)

OCT 26 1992

PURSUANT TO 807 KAR 5:011,  
SECTION 9 (1)

BY: George Walker  
PUBLIC SERVICE COMMISSION MANAGER

Issued: September 24, 1992

Effective: October 26, 1992

Robert E. Aigmon for President, Cincinnati, Ohio

Vice President - Regulatory Affairs

ACCESS SERVICE TARIFF  
PSC No. 2

CINCINNATI BELL TELEPHONE COMPANY

1st Revised Page 155  
Cancels Original Page 155

5. Ordering Options for Switched and Special Access Service (Cont'd)

5.5 Access Order Standard Intervals (Cont'd)

5.5.3 (Reserved)

(D)

(D)

PUBLIC SERVICE COMMISSION  
OF KENTUCKY  
EFFECTIVE

OCT 26 1992

PURSUANT TO 807 KAR 5:011,  
SECTION 9 (1)

Issued: September 24, 1992

Effective: October 26, 1992  
BY: Clay Hall  
PUBLIC SERVICE COMMISSION MANAGER

Robert E. Sigmon for President, Cincinnati, Ohio

Vice President - Regulatory Affairs

ACCESS SERVICE TARIFF  
PSC No. 2

CINCINNATI BELL TELEPHONE COMPANY

Original Page 156

6. Switched Access Service

6.1 General

Switched Access Service, which is available to customers for their use in furnishing their services to end users, provides a two-point electrical communications path between a customer's premises and an end user's premises. It provides for the use of common terminating, switching and trunking facilities and common subscriber plant of the Telephone Company. Switched Access Service provides for the ability to originate calls from an end user's premises to a customer's premises, and to terminate calls from a customer's premises to an end user's premises in the LATA where it is provided. Specific references to material describing the elements of Switched Access Service are provided in 6.1.1 and 6.1.3 following.

Rates and charges for Switched Access Service depend generally on its use by the customer, i.e., for MTS or WATS services, MTS-WATS equivalent services, or other services (e.g., foreign exchange service). Rates and charges for Switched Access Service are set forth in 6.8 following. The application of rates for Switched Access Service is described in 6.7 following. Rates and charges for services other than Switched Access Service, e.g., a customer's interLATA toll message service, may also be applicable when Switched Access Service is used in conjunction with these other services. Descriptions of such applicability are provided in 6.2.1(A)(7), 6.2.1(B)(4), 6.2.2(A)(5), 6.2.4(A)(4), 6.7.10 and 6.7.12 following. Finally, a credit is applied against line side Switched Access Service charges as described in 6.7.11 following.

**PUBLIC SERVICE COMMISSION  
OF KENTUCKY  
EFFECTIVE**

MAR 3 1992

**PURSUANT TO 807 KAR 5.011,  
SECTION 9 (1)**

BY: James L. Miller  
Effective March 3, 1992

Issued: February 7, 1992

James L. Miller for President, Cincinnati, Ohio

Vice President - Regulatory Affairs

6. Switched Access Service (Cont'd)

6.1 General (Cont'd)

6.1.1 Switched Access Service Arrangements and Manner of Provision

Switched Access Services are differentiated by their technical characteristics, e.g., line side vs. trunk side connection at the Telephone Company entry switch, and the manner in which an end user accesses them in originating calling, e.g., with or without an access code. Following is a brief description of each type of service arrangement.

(A) Feature Group A (FGA)

FGA Access, which is available to all customers, provides line side access to Telephone Company end office switches with an associated seven digit local telephone number for the customer's use in originating and terminating communications to an Interexchange Carrier's interstate service or a customer-provided interstate communications capability. The customer must specify the Interexchange Carrier to which the FGA service is connected or, in the alternative, specify the means which the FGA access communications is transported to another state. A more detailed description of FGA Access is provided in 6.2.1 following.

(B) Feature Group B (FGB)

FGB Access, which is available to all customers, provides trunk side access to Telephone Company end office switches with an associated uniform 950-XXXX access code for the customer's use in originating and terminating communications to an Interexchange Carrier's interstate service or a customer-provided interstate communications capability. The customer must specify the Interexchange Carrier to which the FGB service is connected or, in the alternative, specify the means by which the FGB access communications is transported to another state. A more detailed description of FGB Access is provided in 6.2.2 following.

(T)

6. Switched Access Service (Cont'd)

6.1 General (Cont'd)

6.1.1 Switched Access Service Arrangements and Manner of Provision (Cont'd)

(C) Feature Group D (FGD)

FGD Access, which is available to all customers, provides trunk side access to Telephone Company end office switches with an associated uniform 10XXX access code for the customer's use in originating and terminating communications. A more detailed description of FGD Access is provided in 6.2.4 following.

(D) 800 Access Service

800 Access Service, which is available to all customers, is an originating offering utilizing FGD Switched Access Service. The service provides a customer identification function based on the dialed 800 number. The 800 Series includes 800. 888, 877. 866. 855. 844. 833. 822. This customer identification function could include additional call handling and destination features, such as; alternate carrier(s) and/or alternate destinations), time-of-day, day-of-week, specific dates, originating NPA-NXX-XXX, percent allocation, routing to a single carrier and destination from an area of service which is smaller than an area defined by an NPA-NXX, percent allocation, routing to a single carrier and destination from an area of service which is smaller than an area defined by an NPA-NNX. (C)

When a 1 + 800 Series + NXX + XXXX call is originated by an end user, the Telephone Company will perform the customer identification function based on the dialed 1 + 800 Series + NXX + XXXX (ten digit screening) to determine the customer location to which the call is to be routed. Where 800 Series prefixes are not part of ten digit screening, the customer identification function will be performed based on the 800 Series + NXX digits only (e.g., Canada). If an 800 Series call originates from an end office not equipped to provide the SSP Data Base Query function, the call will be routed to an office at which the function is available. The SSP Data Base Query function will be available at the tandem, and select end offices only. Once customer identification has been established, the call will be routed to the customer. (T)

ACCESS SERVICE TARIFF  
PSCK No. 2

CINCINNATI BELL TELEPHONE COMPANY

1st Revised Page 159  
Cancels Original Page 159

6. Switched Access Service (Cont'd)

6.1 General (Cont'd)

6.1.1 Switched Access Service Arrangements and Manner of Provision (Cont'd)

(D) 800 Access Service (Cont'd)

(D)

(D)

PUBLIC SERVICE COMMISSION  
OF KENTUCKY  
EFFECTIVE

MAY I 1993

PURSUANT TO 807 KAR 5:011,  
SECTION 9 (1)

BY: Glenn Walker  
PUBLIC SERVICE COMMISSION MANAGER

Issued: March 25, 1993

Effective: May 1, 1993

*Robert E. Aigmon* for

President, Cincinnati, Ohio

Vice President - Regulatory Affairs

ACCESS SERVICE TARIFF  
PSCK No. 2

CINCINNATI BELL TELEPHONE COMPANY

1st Revised Page 160  
Cancels Original Page 160

6. Switched Access Service (Cont'd)

6.1 General (Cont'd)

6.1.1 Switched Access Service Arrangements and Manner of Provision  
(Cont'd)

(D) 800 Access Service (Cont'd)

Additionally, 800 Access Service usage measurements shall be in (C)  
accordance with the regulations set forth in 6.7.8 following for  
Feature Group D and 6.7.17 for Data Base Queries. Access (C)  
minutes shall be measured in the same manner in which Feature  
Group D access minutes are measured.

Unless prohibited by technical limitations (e.g., different  
dialing plans), the customer's 800 Access Service traffic may,  
at the option of the customer, be combined in the same trunk  
group arrangement with the customer's non-800 Access Service  
traffic. When required by technical limitations, or at the  
request of the customer, a separate trunk group will be  
established for 800 Access Service.

When 800 Access Service traffic is combined in the same trunk  
group arrangement with other traffic, usage for the 800 Access  
Service traffic may be aggregated with or shown separately from  
the other traffic for billing purposes. When separate trunk  
groups are provided for 800 Access Service, usage will be billed  
separately.

PUBLIC SERVICE COMMISSION  
OF KENTUCKY  
EFFECTIVE

MAY 1 1993

PURSUANT TO 807 KAR 5:011,  
SECTION 9 (1)

BY: George Deller  
PUBLIC SERVICE COMMISSION MANAGER  
Effective: May 1, 1993

Issued: March 25, 1993

Robert E. Aigmon

for

President, Cincinnati, Ohio

Vice President - Regulatory Affairs



6. Switched Access Service (Cont'd)

6.1 General (Cont'd)

6.1.1 Switched Access Service Arrangements and Manner of Provision (Cont'd)

(E) 900 Access Service

Originating 900 Access Service is an offering utilizing trunk side Switched Access Service. The service provides a customer identification function based on the dialed 900 number.

When a 1 + 900 + NXX + XXXX or 0 + 900 + NXX + XXXX call is originated by an end user, the Telephone Company will perform the customer identification function based on the 900 + NXX digits dialed to determine the customer location to which the call is to be routed. (T)

900 Access Service may be provisioned With 1+900+NXX-XXXX dialing capability or expanded to include 0+900+NXX-XXXX dialing capability. The expanded 900 option is not offered without 1+900 Access Service within a LATA.

Calls originating to 900 Access Service NXX Codes which the customer has not ordered opened in the LATA will be blocked. Only customers who order 0+900 dialing capability will be able to receive 0+900 calls to NXX codes assigned to them. In addition, calls originating in a LATA for which 900 Access Service has been established will be blocked utilizing the blocking specifications as follows:

If 1+900 dialing capability is ordered, calls from coin telephone, Inmate Service, Hotel/Motel Service, and calls made using 0+ (unless 0+900 dialing capability is ordered), 0- and 10XXX will be blocked. (T)

If 0+900 dialing capability is ordered, calls from Inmate Service, and calls made using 0-. will be blocked. (T)

900 Access Service will be provisioned in accordance with the technical characteristics available with Feature Group D., i.e. technical specifications, Telephone Company switching system and customer premises interfaces, design blocking criteria and address signaling, etc.

ACCESS SERVICE TARIFF  
PSCK No. 2

CINCINNATI BELL TELEPHONE COMPANY

1st Revised Page 162  
Cancels Original Page 162

6. Switched Access Service (Cont'd)

6.1 General (Cont'd)

6.1.1 Switched Access Service Arrangements and Manner of Provision  
(Cont'd)

(E) 900 Access Service (Cont'd)

Usage measurements on 900 Access Service shall be in accordance with the regulations set forth in 6.7.8 following for Feature Group D. Access minutes shall be measured in the same manner as Feature Group D access minutes are measured.

Unless prohibited by technical limitations, e.g., different dialing plans, the customer's 900 Access Service traffic may, at the option of the customer, be combined in the same trunk group arrangement with the customer's other Access Service traffic (non-900). When required by technical limitations or at the request of the customer, a separate trunk group will be established for 900 Access Service.

When 900 Access Service traffic is combined in the same trunk group arrangement with other traffic, usage for the 900 Access Service traffic may be aggregated with or shown separately from the other traffic for billing purposes. When separate trunk groups are provided for 900 Access Service, usage will be billed separately.

The Telephone Company may, at its option, implement network management controls, e.g., call gapping and code blocking, to protect the network from traffic surges due to peaked 900 Access Service. Customer notification of its peaked service is required in accordance with paragraph 6.6.1(E).

The nonrecurring charges for 900 Access Service are described in 6.7.1(C) (3).

PUBLIC SERVICE COMMISSION  
OF KENTUCKY  
EFFECTIVE

(T)

MAY 23 1995

PURSUANT TO 807 KAR 5011,  
SECTION 9(1)

BY: Jordan C. Neal  
FOR THE PUBLIC SERVICE COMMISSION

Issued: June 13, 1995

Effective: May 23, 1995

Deborah A. Nisch President, Cincinnati, Ohio  
Vice President  
Integrated Corporate Planning for

6. Switched Access Service (Cont'd)

6.1 General (Cont'd)

6.1.1 Switched Access Service Arrangements and Manner of Provision  
(Cont'd)

(P) Manner of Provision

Switched Access is furnished in either quantities of lines or trunks. FGA is furnished on a per-line basis. FGB Access and FGD Access are furnished on a per trunk basis.

(C)  
|  
(C)

Trunks are differentiated by type and directionality of traffic carried over a Switched Access Service arrangement. Differentiation of traffic is necessary for the Telephone Company to properly design Switched Access Service to meet the traffic carrying capacity requirement of the customer.

(C)

PUBLIC SERVICE COMMISSION  
OF KENTUCKY  
EFFECTIVE

MAY 23 1995

PURSUANT TO 807 KAR 5:011,  
SECTION 9(1)

BY: Jordan C. Neal  
FOR THE PUBLIC SERVICE COMMISSION

There are four major traffic types. These are: Originating, Terminating, 64 Clear Channel Capability (64CCC) and Directory Assistance. Originating traffic type represents access capacity within a LATA for carrying traffic from the end user to the customer. Terminating traffic type represents access capacity within a LATA for carrying traffic from the customer to the end user; 64CCC traffic type represents access capacity within a LATA for carrying digital traffic at speeds up to 64Kbps between the customer and the end user; and, Directory Assistance traffic type represents access capacity within a LATA for carrying Directory Assistance traffic from the customer to a Directory Assistance location. Directory Assistance traffic type is used for ordering Directory Assistance Access Service as set forth in 9. following.

(C)  
(N)  
(N)

(C)  
|  
(C)

If customers wish to further segregate their originating FGD, 800 Access Service or 900 Access Service traffic into separate trunk groups, the originating traffic type must be specified. Originating traffic type is categorized into Domestic, 800, 900, Operator and IDDD. Domestic traffic type represents access capacity for carrying only domestic traffic other than 800, 900 and Operator traffic; IDDD traffic type represents access capacity for carrying only international traffic; and, 800, 900 and operator traffic type represents access capacity for carrying, respectively, only 800, 900 or Operator traffic.

Issued: June 13, 1995  
Deborah R. Risch

Effective: May 23, 1995

Vice President  
Integrated Corporate Planning for President, Cincinnati, Ohio

ACCESS SERVICE TARIFF  
PSC No. 2

CINCINNATI BELL TELEPHONE COMPANY

Original Page 163.1

6. Switched Access Service (Cont'd)

6.1 General (Cont'd)

6. 1.1 Switched Access Service Arrangements and Manner of Provision (Cont'd)

(G) 500 Access Service

Originating 500 Access Service is an offering utilizing trunk side Switched Access Service. The service provides a customer identification function based on the dialed 500 number.

When a 1+500+NXX+XXX or 0+500+NXX+XXXX call is originated by an end user, the Telephone Company will perform the customer identification function based on the 500 + NXX digits dialed to determine the customer location to which the call is to be routed.

500 Access Service may be provisioned with 1+500+NXX-XXXX dialing capability and 0+500+NXX-XXXX dialing capability. However, 0+500 is not offered without 1+500 Access Service within a LATA.

Calls originating to 500 Access Service NXX Codes which the customer has not ordered opened in the LATA will be blocked. Only customers who order 0+500 dialing capability will be able to receive 0+500 calls to NXX codes assigned to them. In addition, calls originating in a LATA for which 500 Access Service has been established will be blocked utilizing the blocking specifications as follows:

- If 1+500 dialing capability is ordered, calls from Inmate Service, Hotel/Hotel Service, 0+ (unless 0+ dialing capability is ordered), 0-, 10XXX and 10XXXX will be blocked.
- If 0 + 500 dialing capability is ordered and calls made using 0- will be blocked.

500 Access Service will be provisioned in accordance with the technical characteristics available with Feature Group D., i.e., technical specifications, Telephone Company switching system and customer premises interfaces, design blocking criteria and address signaling, etc.

(N)

(N)

6. Switched Access Service (Cont'd)

6.1 General (Cont'd)

6.1.1 Switched Access Service Arrangements and Manner of Provision  
(Cont'd)

(G) 500 Access Service (Cont'd)

(N)

Usage measurements on 500 Access Service shall be in accordance with the regulations set forth in 6.7.8 following for Feature Group D.

Unless prohibited by technical limitations, e.g., different dialing plans, the customer's 500 Access Service traffic may, at the option of the customer, be combined in the same trunk group arrangement with the customer's other Access Service traffic (non-500). When required by technical limitations or at the request of the customer, a separate trunk group will be established for 500 Access Service.

When 500 Access Service traffic is combined in the same trunk group arrangement with other traffic, usage for the 500 Access Service traffic may be aggregated with or shown separately from the other traffic for billing purposes. When separate trunk groups are provided for 500 Access Service, usage will be billed separately.

The Telephone Company may, at its option, implement network management controls, e.g., call gapping and code blocking, to protect the network from traffic surges due to peaked 500 Access Service. Customer notification of its peaked service is required in accordance with paragraph 6.6.1(E).

The nonrecurring charges for 500 Access Service are described in

ACCESS SERVICE TARIFF  
PSCK No. 2

CINCINNATI BELL TELEPHONE COMPANY

1st Revised Page 164  
Cancels *Original* Page 164

6. Switched Access Service (Cont'd)

6.1 General (Cont'd)

6.1.2 WATS Access Line Service

WATS Access Line Service is a type of Special Access Service that is provided for use with Feature Group A, B and D Switched Access Service. WATS Access Line Service connects an end user premises with a WATS serving office. This Service is described in 7.2.3 following.

6.1.3 Rate Categories

There are three rate categories which apply to Switched Access Service:

- **Switched** Transport (described in 6.1.3(B) following) (C)
- Local Switching (described in 6.1.3(C) following)
- Common Line (described in Section 3. preceding)

In addition to the three rate categories, there is an Equal Access Recovery Charge that applies to FGD Switched Access Service and an Information Surcharge that applies to all Switched Access Services. The description and application of these charges are set forth in 6.7.15 and 6.7.16 following for the Equal Access Recovery Charge and the Information Surcharge, respectively.

PUBLIC SERVICE COMMISSION  
OF KENTUCKY  
EFFECTIVE .

MAY 23 1995

PURSUANT TO 807 KAR 5:011,  
SECTION 9(1)

BY: Jordan C. Neel  
FOR THE PUBLIC SERVICE COMMISSION

Issued: June 13, 1995

Effective: **May** 23, 1995

Deborah A. Risch President, Cincinnati, Ohio

Vice President  
Integrated Corporate Planning for

ACCESS SERVICE TARIFF  
PSCK No. 2

CINCINNATI BELL TELEPHONE COMPANY

PUBLIC SERVICE COMMISSION  
1st Revised Page 165  
Cancels Original Page 165  
EFFECTIVE

6. Switched Access Service (Cont'd)

6.1 General (Cont'd)

6.1.3 Rate Categories (Cont'd)

MAY 23 1995

PURSUANT TO 807 KAR 5:011,  
SECTION 9(1)

BY: *Jordan C. Neal*  
FOR THE PUBLIC SERVICE COMMISSION

The following diagram depicts a generic view of the components of Switched Access Service and the manner in which the components are combined to provide a complete Access Service.

1) DIRECT-TRUNKED TRUNK SIDE SERVICES AND ORIGINATING LINE SIDE SERVICES

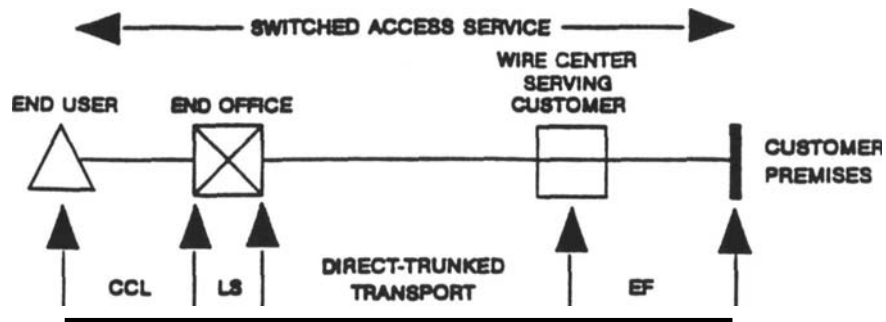

NOTE:

An exception to mileage measurement for originating line side services is set forth in 6.7.13 (Mileage Measurement).

2) TANDEM-SWITCHED TRUNK SIDE SERVICES

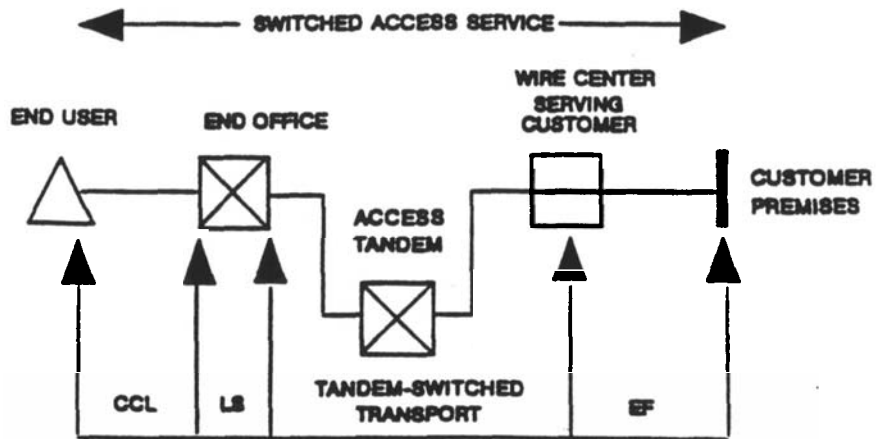

CCL: CARRIER COMMON LINE  
LS: LOCAL SWITCHING  
EF: ENTRANCE FACILITY

\* Common Line access is provided under Sections 3 and 4 preceding.

(C)

Issued: June 13, 1995

Effective: May 23, 1995

*Deborah A. Nisch*  
Vice President  
Integrated Corporate Planning for

President, Cincinnati, Ohio

6. Switched Access Service (Cont'd)

6.1 General (Cont'd)

6.1.3 Rate Categories (Cont'd)

PUBLIC SERVICE COMMISSION  
OF KENTUCKY  
EFFECTIVE

MAY 23 1995

PURSUANT TO 807 KAR 5.01  
SECTION 9(1)

BY: *Jordan C. Neel*  
FOR THE PUBLIC SERVICE COMMISSION

3) **TERMINATING LINE SIDE SERVICES**

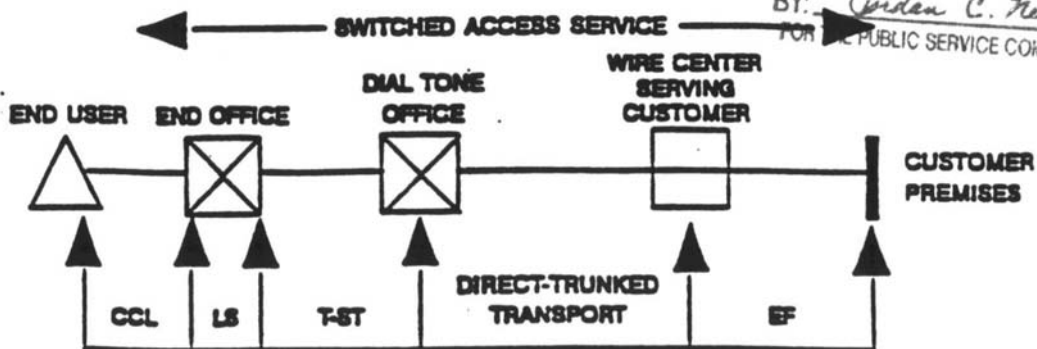

4) **DIRECT-TRUNKED HOST/REMOTE ARRANGEMENTS**

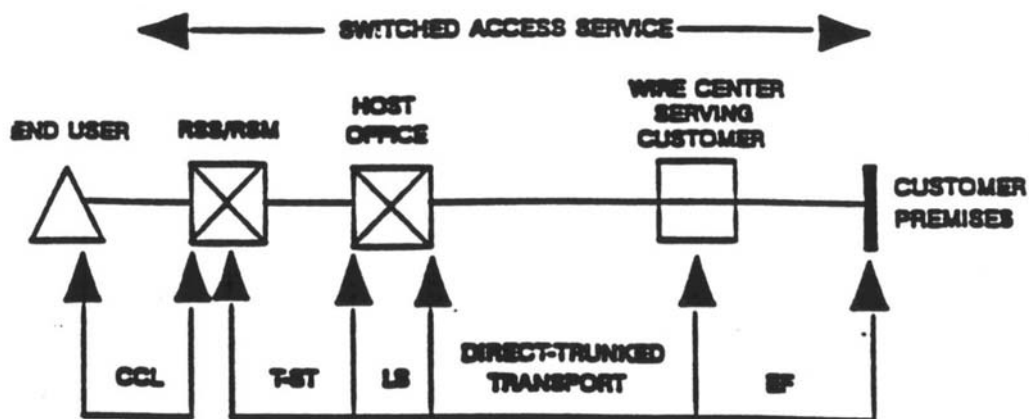

- CCL: CARRIER COMMON LINE
- LS: LOCAL SWITCHING
- T-ST: TANDEM-SWITCHED TRANSMISSION
- EF: ENTRANCE FACILITY
- RRS/RSM: REMOTE SWITCHING SYSTEM/REMOTE SWITCHING MODULE

\* Common Line access is provided under Sections 3 and 4 preceding.

Issued: June 13, 1995

Effective: May 23, 1995

President, Cincinnati, Ohio

*Deborah A. Nisch*

Vice President  
Integrated Corporate Planning for

(C)



6. Switched Access Service (Cont'd)

6.1 General (Cont'd)

6.1.3 Rate Categories (Cont'd)

5) TANDEM-SWITCHED HOST/REMOTE ARRANGEMENTS.

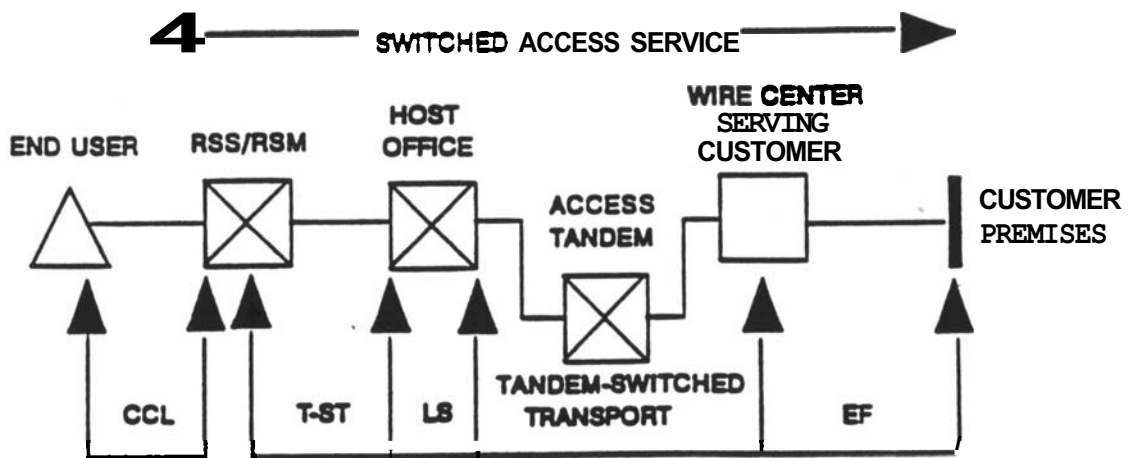

**CCL:** CARRIER COMMON LINE  
**LS:** LOCAL SWITCHING  
**T-ST:** TANDEM-SWITCHED TRANSMISSION  
**EF:** ENTRANCE FACILITY  
**RSS/RSM:** REMOTE SWITCHING SYSTEM/REMOTE SWITCHING MODULE

\* Common Line access is provided under Sections 3 and 4 preceding. PUBLIC SERVICE COMMISSION OF KENTUCKY EFFECTIVE

MAY 23 1995

PURSUANT TO 807 KAR 5011,  
SECTION 9(1)

BY: Jordan C. Neel  
FOR THE PUBLIC SERVICE COMMISSION

Issued: June 13, 1995

Effective: May 23, 1995

President, Cincinnati, Ohio

*Deborah A. Nisch*  
Vice President  
Integrated Corporate Planning for

ACCESS SERVICE TARIFF  
PSCK No 2

CINCINNATI BELL TELEPHONE COMPANY

2nd Revised Page 166  
Cancels 1st Revised Page 166

PUBLIC SERVICE COMMISSION  
OF KENTUCKY  
EFFECTIVE

6. Switched Access Service (Cont'd)

6.1 General (Cont'd)

6.1.3 ~~Rate Categories~~ (Cont'd)

(A)

(B) ~~Switched Transport~~

MAY 23 1995

PURSUANT TO 807 KAR 5.011,  
SECTION 9(1)

BY: Jordan C. Neel (C)  
FOR THE PUBLIC SERVICE COMMISSION (C)

~~The Switched Transport rate category establishes the~~ charges related to the transmission and tandem facilities between the customer's premises and the end office switch(es) which may be a Remote Switching Module, where the customer's traffic is switched to originate or terminate the customer's communications. Mileage measurement rules are set forth in 6.7.13.

Switched Transport is a **two-way** voice frequency transmission path composed of facilities determined by the Telephone Company. The **two-way** voice frequency transmission permits the transport of calls in the originating direction (from the end user's end office switch to the customer's premises) and in the terminating direction (from the customer's premises to the end office switch), but not simultaneously. The voice frequency transmission path may be comprised of any form or configuration of plant capable of and typically used in the telecommunication industry for the transmission of voice and associated telephone signals within the frequency bandwidth of approximately 300 to 3000 Hz.

The customer must specify when ordering (1) whether the service is to be directly routed to an end office switch or through an access tandem switch, (2) the type of **Direct-Trunked Transport** and whether it will overflow to **Tandem-Switched Transport** when service is directly routed to an end office, (3) the type of Entrance Facility, (4) the directionality of the service, and (5) when **multiplexing** is required, the hub(s) at which the multiplexing will be provided.

Additionally, when service is to be routed through an access tandem switch, the customer must specify whether the facility between the serving wire center and the tandem is to be provided as **Direct-Trunked Transport** or **Tandem-Switched Transport**.

Issued: June 13, 1995

Effective: May 23, 1995

*Deborah A. Nisch*

President, Cincinnati, Ohio

Vice President  
Integrated Corporate Planning for

ACCESS SERVICE TARIFF  
PSCK No. 2

CINCINNATI BELL TELEPHONE COMPANY

Original Page 166.1  
PUBLIC SERVICE COMMISSION  
OF KENTUCKY  
EFFECTIVE

6. Switched Access Service (Cont'd)

6.1 General (Cont'd)

6.1.3 Rate Categories (Cont'd)

(B) Switched Transport (Cont'd)

Switched Transport is provided at the rates and charges set forth in 6.8.2 following. The application of these rates with respect to the different types of service is set forth in 6.7.1(D) following.

(1) Switched Transport Facilities

(a) Entrance Facility

An Entrance Facility provides the communication path between a customer's premises and the Telephone Company's serving wire center for that premises. The Entrance Facility is provided to a single customer and is available for use with all line side and trunk side Switched Access services. An Entrance Facility is provided even if the customer's premises and the serving wire center are located in the same building.

(b) Direct-Trunked Transport Facility

A Direct-Trunked Transport facility provides the communications path between the serving wire center of a customer's premises and an end office, between the serving wire center of a customer's premises and the Telephone Company's Access tandem. Direct-Trunked Transport facilities are provided to a single customer. Direct-Trunked Transport facilities are available for use with all line side and trunk side Switched Access services.

Direct-Trunked Transport facilities are not available to end offices without recording and measuring capabilities, such as a remote end office. Direct-Trunked Transport facilities are also not available for 800 Access Service when the required SSP function is located at the access tandem.

MAY 23 1995

PURSUANT TO 807 KAR 5:011,  
SECTION 9(1)

BY: Jordan C. Neel (C)  
FOR THE PUBLIC SERVICE COMMISSION (C)

(N)

(N)

Issued: June 13, 1995

Effective: May 23, 1995

*Deborah A. Bishop*

President, Cincinnati, Ohio

Vice President

Integrated Corporate Planning for

CINCINNATI BELL TELEPHONE COMPANY

Original Page 166.2

6. Switched Access Service (Cont'd)

PUBLIC SERVICE COMMISSION  
OF KENTUCKY  
EFFECTIVE

6.1 General (Cont'd)

MAY 23 1995

6.1.3 Rate Categories (Cont'd)

PURSUANT TO 807 KAR 5.011, (C)  
SECTION 9(1) (N)  
Jordan C. Neal  
FOR THE PUBLIC SERVICE COMMISSION

(B) Switched Transport (Cont'd)

(1) Switched Transport Facilities

(c) Tandem-Switched Transport Facility

The Tandem-Switched Transport facility provides the communications path between the customer's serving wire center and the end office or between the tandem and the end office on circuits that are switched at an access tandem. Tandem-Switched Transport facilities are available for use with all trunk side Switched Access Services.

Tandem-Switched Transport charges consist of a Tandem-Switched Transmission charge (fixed and per mile minute of use charges) and a Tandem-Switching charge (per minute charge) where elements may apply independently of one another as described herein.

(d) Host/Remote Arrangements

When Direct-Trunked Transport is provided to a Host/Remote arrangement, Direct-Trunked Transport rates apply between the customer's serving wire center and the Host office serving the Remote office. When Tandem-Switched Transport is provided, Tandem-Switched Transmission charges and Tandem-Switching charges apply from the customer's serving wire center to the Host office. In both cases, Tandem-Switched Transmission charges apply from the Host office to the Remote office.

(2) Switched Transport Connections

Switched Transport is comprised of specific connection types. These connections may be either analog or digital. Analog connections are differentiated by spectrum and bandwidth; digital connections are differentiated by bit rate. Depending on the spectrum, bandwidth or bit rate selected by the customer, multiplexing, as described in 6.1.3(B)(3), may also be required to allow interconnection with other Switched Transport facilities or to a Telephone Company switch.

(N)

Issued: June 13, 1995

Effective: May 23, 1995

*Deborah H. Hesch*

President, Cincinnati, Ohio

Vice President  
Integrated Corporate Planning for

ACCESS SERVICE TARIFF  
PSCK No. 2

CINCINNATI BELL TELEPHONE COMPANY

PUBLIC SERVICE COMMISSION  
Original Page 165 of 169  
OF KENTUCKY  
EFFECTIVE

6. Switched Access Service (Cont'd)

6.1 General (Cont'd)

MAY 23 1995

6.1.3 Rate Categories (Cont'd)

PURSUANT TO 807 KAR 5.011,  
SECTION 9 (1)

(B) ~~Switched Transport~~ (Cont'd)

BY: Jordan C. Hill (C)  
FOR THE PUBLIC SERVICE COMMISSION (N)

(2) Switched Transport Connections (Cont'd)

With one exception, the customer may choose the Switched Transport connection comprising the Switched Transport facility. For the tandem to end office portion of Tandem-Switched Transport, the Telephone Company will determine the type of connection used. For all other requests, the customer may specify the connection by specifying an interface group, as set forth in 6.1.3(B)(5).

Each type of connection is composed of specific channels which are provided for use with a Switched Access service. Each channel in a Switched Transport connection equates to a transmission path. The following types of connections are available for all Switched Transport facilities.

(a) Voice Grade Service

A Voice Grade channel is a channel which provides voice frequency transmission capability in the normal frequency range of 300 to 3000Hz and may be terminated two-wire or four-wire. When a single Voice Grade channel is ordered to be terminated at a customer's premises where the premises is all digital and requires a minimum digital interface level of 1.544 Mbps (DS1), the Telephone Company will provide the required interface where facilities are available.

Technical Specifications for Voice Grade may be found in the following Technical Reference Publications:

TR-TSY-000335  
PUB 41004, Table 4  
TR-INS-000342

Issued: June 13, 1995

Effective: May 23, 1995

Deborah A. Nisen President, Cincinnati, Ohio  
Vice President  
Integrated Corporate Planning for

ACCESS SERVICE TARIFF  
PSC No. 2

CINCINNATI BELL TELEPHONE COMPANY

Original Page 166.4  
PUBLIC SERVICE COMMISSION  
OF KENTUCKY  
EFFECTIVE

6. Switched Access Service (Cont'd)

6.1 General (Cont'd)

6.1.3 Rate Categories (Cont'd)

(B) Switched Transport (Cont'd)

(2) Switched Transport Connections (Cont'd) *Jordan C. Neal (N)*  
PURSUANT TO 807 KAR 5:01  
SECTION 9(1)  
FOR THE PUBLIC SERVICE COMMISSION

(b) MercNET 1.544 (DS1)

A MercNET 1.544 (DS1) provides 24 channels for the transmission of nominal 64.0 kbps or 1.544 Mbps isochronous serial data. The actual bit rate and framing format is a function of the channel interface selected by the customer.

Technical specifications for MercNET 1.5 (DS1) may be found in the following Technical Reference Publications:

PUB-62411  
TR-INS-000342

(c) MercNET 45 (DS3)

MercNET 45 (DS3) provides 28 MercNET 1.544s (DS1) or 672 DSO channels and provides for transmission of nominal 44.736 Mbps isochronous serial data. The actual bit rate and framing format is a function of the channel interface selected by the customer. With MercNET 45 (DS3), customers may request to have an electrical interface installed at their customer premises. For DS3 connections utilizing an electrical interface, the customer will receive an electrical signal with a transmission speed of 44.736 Mbps per channel.

Technical specifications for DS3 may be found in the following Technical Reference Publications:

TR-INS-000342

(N)

Issued: June 13, 1995

Effective: May 23, 1995

*Deborah A. Nisch*  
President, Cincinnati, Ohio

Vice President  
Integrated Corporate Planning for

ACCESS SERVICE TARIFF  
PSCK No. 2

CINCINNATI BELL TELEPHONE COMPANY

Original Page 166.5

6. Switched Access Service (Cont'd)

6.1 General (Cont'd)

6.1.3 Rate Categories (Cont'd)

(B) Switched Transport (Cont'd)

(3) Multiplexing

Multiplexing provides the capability of converting the capacity or bandwidth of a Switched Transport facility from a higher level to a lower level or from a lower level to a higher level. Multiplexing is required when the customer requests to interconnect Entrance facilities or Direct-Trunked Transport facilities of different capacities or bandwidths, i.e., DS1 to Voice Grade or DS3 to DS1.

When customers request to interconnect DS3 facilities with Telephone Company switches, DS3 to DS1 multiplexing is required at appropriately equipped end offices. Locations where multiplexing is available are specified in the NECA Tariff F.C.C. No. 4.

Rates and charges for multiplexing are set forth in 6.8.2.

(C)

(D)

(N)

PUBLIC SERVICE COMMISSION  
OF KENTUCKY  
EFFECTIVE

MAY 23 1995

PURSUANT TO 807 KAR 5:011,  
SECTION 9(1)

BY: Jordan C. Neal  
FOR THE PUBLIC SERVICE COMMISSION

Issued: June 13, 1995

Effective: May 23, 1995

 \*President, Cincinnati, Ohio  
Vice President  
Integrated Corporate Planning for

ACCESS SERVICE TARIFF  
PSCK No. 2

CINCINNATI BELL TELEPHONE COMPANY

Original Page 1636  
PUBLIC SERVICE COMMISSION  
OF KENTUCKY  
EFFECTIVE

6. Switched Access Service (Cont'd)

6.1 General (Cont'd)

6.1.3 Rate Categories (Cont'd)

(B) Switched Transport (Cont'd)

(3) Multiplexing (Cont'd)

MAY 23 1995

PURSUANT TO 807 KAR 5:011,  
SECTION 9 (1) (C)

BY: Jordan C. Neel  
FOR THE PUBLIC SERVICE COMMISSION (N)

For each of the multiplexing options listed below, the multiplexer is associated with the Switched Transport facility with the higher capacity or bandwidth (e.g., a DS3 to DS1 multiplexer is associated with the facility DS3 connection).

(a) **MercNET 45 (DS3) to MercNET 1.544 (DS1)**

Available with all Switched Transport facilities using DS3 connections. Provides an arrangement that converts a DS3 signal to or from 28 DS1 channels. Conversion is accomplished using digital time division multiplexing.

(b) **MercNET 1.544 (DS1) to Voice Grade**

Available with all Switched Transport facilities using DS1 connections. Provides an arrangement that converts a DS1 connection to or from 24 voice grade channels. Conversion is accomplished using digital time division multiplexing.

(4) **Interconnection Charge**

The Interconnection Charge recovers the costs associated with Switched Transport that are not recovered by Entrance Facilities, Direct-Trunked Transport, Tandem-Switched Transport, Multiplexing, or CCSAC rates. The Interconnection Charge applies to all access minutes of use (i.e., both Tandem-Switched and Direct-Trunked).

Issued: June 13, 1995

Effective: May 23, 1995

  
President, Cincinnati, Ohio  
Vice President  
Integrated Corporate Planning for



ACCESS SERVICE TARIFF  
PSC No. 2

CINCINNATI BELL TELEPHONE COMPANY

1st Revised Page 167  
Cancels Original Page 167

6. Switched Access Service (Cont'd)

6.1 General (Cont'd)

6.1.3 Rate Categories (Cont'd)

(B) Switched Transport (Cont'd)

(C)

(5) Interface Groups

(T)

**Four** Interface Groups are provided for terminating an Entrance Facility at the customer's premises. Interface groups define the transmission characteristics associated with the Entrance Facility and all transport facilities with which it is interconnected. (C)

As a result of the customer's access order and the type of Telephone Company transport facilities serving the customer's premises, the need for signaling conversions or two-wire to four-wire conversions, or the need to terminate digital or high frequency facilities in channel bank equipment may require that Telephone Company equipment be placed at the customer's premises. For example, if a voice frequency interface is ordered by the customer and the Telephone Company facilities serving the customer's premises are digital, then Telephone Company channel bank equipment must be placed at the customer's premises in order to provide the voice frequency interface ordered by the customer.

PUBLIC SERVICE COMMISSION  
OF KENTUCKY  
EFFECTIVE

MAY 23 1995

PURSUANT TO 807 KAR 5011,  
SECTION 9(1)

BY: Jordan C. Neel  
FOR THE PUBLIC SERVICE COMMISSION

Issued: June 13, 1995

Effective: ~~May~~ 23, 1995

 President, Cincinnati, Ohio  
Vice President  
Integrated Corporate Planning for

ACCESS SERVICE TARIFF  
PSCK No. 2

CINCINNATI BELL TELEPHONE COMPANY

1st Revised Page 168  
Cancels Original Page 168

6. Switched Access Service (Cont'd)

6.1 General (Cont'd)

6.1.3 Rate Categories (Cont'd)

(B) Switched Transport (Cont'd)

(C)

(5) Interface Groups (Cont'd)

(T)

All Interface Groups are provided with transmission specifications and data transmission parameters. Specific technical parameters are set forth in Technical Reference **TR-NWT-000334**.

(C)

(C)

Only certain premises interfaces are available at the customer's premises. The premises interfaces associated with the Interface Groups may vary among different types of service. The various premises interfaces which are available with the Interface Groups, and the Feature Groups with which they may be used, are set forth in (5)(k) following.

(T)

(a) Interface Group 1 (USOC TPPLX)

Interface Group 1, except as set forth in the following, provides two-wire voice frequency transmission at the point of termination at the customer's premises.

(D)

(D)

Interface Group 1 is not provided in association with FGD when the first point of switching is an access tandem. In addition, Interface Group 1 is not provided in association with FGB or FGD when the first point of switching provides only ~~four-wire~~ terminations.

PUBLIC SERVICE COMMISSION  
OF KENTUCKY  
EFFECTIVE

MAY 23 1995

PURSUANT TO 807 KAR 5:011,  
SECTION 9(1)

BY: Jordan C. Neal  
FOR THE PUBLIC SERVICE COMMISSION

Issued: ~~June~~ 13, 1995

Effective: ~~May~~ 23, 1995

Deborah A. Nisch

President, Cincinnati, Ohio

Vice President  
Integrated Corporate Planning for

ACCESS SERVICE TARIFF  
PSCK No. 2

CINCINNATI BELL TELEPHONE COMPANY

1st Revised Page 169  
Cancels Original Page 169

6. Switched Access Service (Cont'd)

6.1 General (Cont'd)

6.1.3 Rate Categories (Cont'd)

(B) Switched Transport (Cont'd)

(5) Interface Groups (Cont'd)

(C)

(T)

(D)

(D)

(b) Interface Group 2 (USOC TTP2X)

Interface Group 2 provides four-wire voice frequency transmission at the point of termination at the customer's premises.

(D)

PUBLIC SERVICE COMMISSION  
OF KENTUCKY  
EFFECTIVE .

MAY 23 1995

PURSUANT TO 807 KAR 5:011,  
SECTION 9 (1)  
BY: Jordan C. Neal  
FOR THE PUBLIC SERVICE COMMISSION

(D)

Issued: ~~June~~ June 13, 1995

Effective: May 23, 1995

*Deborah A. Nisch* President, Cincinnati, Ohio  
Vice President  
Integrated Corporate Planning for

ACCESS SERVICE TARIFF  
PSCK No. 2

CINCINNATI BELL TELEPHONE COMPANY

1st Revised Page 170  
Cancels Original Page 170

6. Switched Access Service (Cont'd)

6.1 General (Cont'd)

6.1.3 Rate Categories (Cont'd)

(B) Switched Transport (Cont'd)

(C)

(5) Interface Groups (Cont'd)

(T)

(D)

PUBLIC SERVICE COMMISSION  
OF KENTUCKY  
EFFECTIVE

MAY 23 1995

PURSUANT TO 807 KAR 5.011,  
SECTION 9(1)

BY: Jordan C. Neel  
FOR THE PUBLIC SERVICE COMMISSION

(D)

Issued: June 13, 1995

Effective: May 23, 1995

Deborah A. Nisch President, Cincinnati, Ohio  
Vice President  
Integrated Corporate Planning for

ACCESS SERVICE TARIFF  
PSC No. 2

CINCINNATI BELL TELEPHONE COMPANY

1st Revised Page 171  
Cancels Original Page 171

6. Switched Access Service (Cont'd)

6.1 General (Cont'd)

6.1.3 Rate Categories (Cont'd)

(B) Switched Transport (Cont'd)

(C)

(5) Interface Groups (Cont'd)

(T)

(D)

PUBLIC SERVICE COMMISSION  
OF KENTUCKY  
EFFECTIVE

MAY 23 1995

PURSUANT TO 807 KAR 5.011,  
SECTION 9 (1)

BY: Jordan C. Neal  
FOR THE PUBLIC SERVICE COMMISSION

(D)

(f) Interface Group 6 (USOC TPP6X)

Interface Group 6 provides DS1 level digital transmission at the point of termination at the customer's premises. The interface is capable of transmitting electrical signals at a nominal 1.544

Issued: June 13, 1995

Effective: May 23, 1995



President, Cincinnati, Ohio

Vice President  
Integrated Corporate Planning for

ACCESS SERVICE TARIFF  
PSC No. 2

CINCINNATI BELL TELEPHONE COMPANY

1st Revised Page 172  
Cancels Original Page 172

6. Switched Access Service (Cont'd)

6.1 General (Cont'd)

6.1.3 Rate Categories (Cont'd)

(B) Switched Transport (Cont'd)

(C)

(5) Interface Groups (Cont'd)

(T)

(f) Interface Group 6 (USOC TPP6X) (Cont'd)

Mbps, with the capability to channelize up to  
24 voice frequency transmission paths.

(D)

PUBLIC SERVICE COMMISSION  
OF KENTUCKY  
EFFECTIVE

MAY 23 1995  
PURSUANT TO 807 KAR 5.011,  
SECTION 9 (1)  
BY: Jordan C. Neal  
FOR THE PUBLIC SERVICE COMMISSION

(D)

Issued: ~~June 13, 1995~~

Effective: ~~May 23, 1995~~

  
Deborah A. Nisch, President, Cincinnati, Ohio  
Vice President  
Integrated Corporate Planning for

ACCESS SERVICE TARIFF  
PSCK No. 2

CINCINNATI BELL TELEPHONE COMPANY

1st Revised Page 173  
Cancels Original Page 173

6. Switched Access Service (Cont'd)

6.1 General (Cont'd)

6.1.3 Rate Categories (Cont'd)

(B) Switched Transport (Cont'd)

(C)

(5) Interface Groups (Cont'd)

(T)

PUBLIC SERVICE COMMISSION  
OF KENTUCKY  
EFFECTIVE

MAY 23 1995

PURSUANT TO 807 KAR 5:011,  
SECTION 9(1)

BY: Jordan C. Neal  
FOR THE PUBLIC SERVICE COMMISSION

Issued: ~~June~~ 13, 1995

Effective: ~~May~~ 23, 1995

Deborah A. Nisich President, Cincinnati, Ohio  
Vice President  
Integrated Corporate Planning for

ACCESS SERVICE TARIFF  
PSC No. 2

CINCINNATI BELL TELEPHONE COMPANY

2nd Revised Page 174  
Cancels 1st Revised Page 174

6. Switched Access Service (Cont'd)

6.1 General (Cont'd)

6.1.3 Rate Categories (Cont'd)

(B) Switched Transport (Cont'd)

(5) Interface Groups (Cont'd)

(C)

(T)

(D)

PUBLIC SERVICE COMMISSION  
OF KENTUCKY  
EFFECTIVE

MAY 23 1995

PURSUANT TO 807 KAR 5:011,  
SECTION 9(1)

BY: Jordan C. Neal  
FOR THE PUBLIC SERVICE COMMISSION

(D)

(k) Available Premises Interface Codes

Following is a matrix showing, for each Interface Group, which premises interface codes are available as a function of the Telephone Company switch supervisory signaling and Feature Group. The explanations of these codes are set forth in Technical Reference TR-NPL-000334.

Issued: June 13, 1995

Effective: **May 23, 1995**

Deborah A. Dirsch President, Cincinnati, Ohio  
Vice President  
Integrated Corporate Planning for



ACCESS SERVICE TARIFF  
PSCK No 2

CINCINNATI BELL TELEPHONE COMPANY

2nd Revised Page 175  
Cancels 1st Revised Page 175

6. Switched Access Service (Cont'd)

6.1 General (Cont'd)

6.1.3 Rate Categories (Cont'd)

(B) Switched Transport (Cont'd)

(C)

(5) Interface Groups (Cont'd)

(T)

(k) Available Premises Interface Codes (Cont'd)

| Interface Group | Telephone Company |                       | Premises Interface Code | Feature Group |   |   |  |
|-----------------|-------------------|-----------------------|-------------------------|---------------|---|---|--|
|                 | Switch            | Supervisory Signaling |                         | A             | B | D |  |
| 1               | LO                |                       | 2LS2                    | X             |   |   |  |
|                 | LO                |                       | 2LS3                    | X             |   |   |  |
|                 | GO                |                       | 2GS2                    | X             |   |   |  |
|                 | GO                |                       | 2GS3                    | X             |   |   |  |
|                 | LO, GO            |                       | 2DX3                    | X             |   |   |  |
|                 | LO, GO            |                       | 4EA3-E                  | X             |   |   |  |
|                 | LO, GO            |                       | 4EA3-M                  | X             |   |   |  |
|                 | LO, GO            |                       | 6EB3-E                  | X             |   |   |  |
|                 | LO, GO            |                       | 6EB3-M                  | X             |   |   |  |
|                 | RV, EA, EB, EC    |                       | 2DX3                    |               | X | X |  |
|                 | RV, EA, EB, EC    |                       | 4EA3-E                  |               | X | X |  |
|                 | RV, EA, EB, EC    |                       | 4EA3-M                  |               | X | X |  |
|                 | RV, EA, EB, EC    |                       | 6EB3-E                  |               | X | X |  |
|                 | RV, EA, EB, EC    |                       | 6EB3-M                  |               | X | X |  |
|                 | EA, EB, EC        |                       | 6EC3                    |               |   | X |  |
|                 | RV                |                       | 2RV3-0                  |               | X | X |  |
|                 | RV                |                       | 2RV3-T                  |               | X | X |  |
|                 | CCS               |                       | 2N02                    |               |   | X |  |
|                 | 2                 | LO, GO                |                         | 4SF2          | X |   |  |
|                 |                   | LO, GO                |                         | 4SF3          | X |   |  |
| LO              |                   |                       | 4LS2                    | X             |   |   |  |
| LO              |                   |                       | 4LS3                    | X             |   |   |  |
| LO              |                   |                       | 6LS2                    | X             |   |   |  |
| GO              |                   |                       | 4GS2                    | X             |   |   |  |
| GO              |                   |                       | 4GS3                    | X             |   |   |  |
| GO              |                   |                       | 6GS2                    | X             |   |   |  |
| LO, GO          |                   |                       | 4DX2                    | X             |   |   |  |
| LO, GO          |                   |                       | 4DX3                    | X             |   |   |  |
| LO, GO          |                   |                       | 6EA2-E                  | X             |   |   |  |
| LO, GO          |                   |                       | 6EA2-M                  | X             |   |   |  |
| LO, GO          |                   |                       | 8EB2-E                  | X             |   |   |  |
| LO, GO          |                   | 8EB2-M                | X                       |               |   |   |  |
| LO, GO          |                   | 6EX2-B                | X                       |               |   |   |  |

(N)

PUBLIC SERVICE COMMISSION  
OF KENTUCKY  
EFFECTIVE

MAY 23 1995

PURSUANT TO 807 KAR 5.011,  
SECTION 9 (1)  
BY: Jordan C. Neal  
FOR THE PUBLIC SERVICE COMMISSION

Issued: June 13, 1995

Effective: May 23, 1995

Deborah A. Nisch President, Cincinnati, Ohio  
Vice President  
Integrated Corporate Planning for

ACCESS SERVICE TARIFF  
PSCK No. 2

CINCINNATI BELL TELEPHONE COMPANY

2nd Revised Page 176  
Cancels 1st Revised Page 176

6. Switched Access Service (Cont'd)

6.1 General (Cont'd)

6.1.3 Rate Categories (Cont'd)

(B) Switched Transport (Cont'd)

(C)

(5) Interface Groups (Cont'd)

(T)

(k) Available Premises Interface Codes (Cont'd)

| <u>Interface Group</u> | <u>Telephone Company</u> |                    |                  | <u>Premises Interface Code</u> | <u>Feature Group</u> |          |          |
|------------------------|--------------------------|--------------------|------------------|--------------------------------|----------------------|----------|----------|
|                        | <u>Switch</u>            | <u>Supervisory</u> | <u>Signaling</u> |                                | <u>A</u>             | <u>B</u> | <u>D</u> |
| 2 (Cont'd)             | RV,                      | EA,                | EB, EC           | 4SF2                           | X                    | X        |          |
|                        | RV,                      | EA,                | EB, EC           | 4SF3                           | X                    |          |          |
|                        | RV,                      | EA,                | EB, EC           | 4DX2                           | X                    | X        |          |
|                        | RV,                      | EA,                | EB, EC           | 4DX3                           | X                    |          |          |
|                        | RV,                      | EA,                | EB, EC           | 6DX2                           |                      |          |          |
|                        | RV,                      | EA,                | EB, EC           | 6EA2-E                         | X                    | X        |          |
|                        | RV,                      | EA,                | EB, EC           | 6EA2-M                         | X                    | X        |          |
|                        | RV,                      | EA,                | EB, EC           | 8EB2-E                         | X                    | X        |          |
|                        | RV,                      | EA,                | EB, EC           | 8EB2-M                         | X                    | X        |          |
|                        | EA,                      | EB,                | EC               | 8EC2-M                         |                      |          | X        |
|                        | RV                       |                    |                  | 4RV2-O                         | X                    | X        |          |
|                        | RV                       |                    |                  | 4RV2-T                         | X                    | X        |          |
|                        | RV                       |                    |                  | 4RV3-O                         | X                    |          |          |
|                        | RV                       |                    |                  | 4RV3-T                         | X                    |          |          |
|                        | CCS                      |                    |                  | 4N02                           |                      |          | X        |

PUBLIC SERVICE COMMISSION  
OF KENTUCKY  
EFFECTIVE

MAY 23 1995

PURSUANT TO 807 KAR 5.011,  
SECTION 9(1)

BY: Jordan C. Neal  
FOR THE PUBLIC SERVICE COMMISSION

Issued: June 13, 1995

Effective: **May 23, 1995**

*Deborah A. Nisch* President, Cincinnati, Ohio  
Vice President  
Integrated Corporate Planning for

ACCESS SERVICE TARIFF  
PSCK No. 2

CINCINNATI BELL TELEPHONE COMPANY

2nd Revised Page 177  
Cancels 1st Revised Page 177

6. Switched Access Service (Cont'd)

6.1 General (Cont'd)

6.1.3 Rate Categories (Cont'd)

(B) Switched Transport (Cont'd)

(C)

(5) Interface Groups (Cont'd)

(T)

(k) Available Premises Interface Codes (Cont'd)

| Interface Group | Telephone Company |                       | Premises Interface Code | Feature Group |   |   |
|-----------------|-------------------|-----------------------|-------------------------|---------------|---|---|
|                 | Switch            | Supervisory Signaling |                         | A             | B | D |
| 6               | LO, GO            |                       | 4DS9-15                 | X             |   |   |
|                 | LO, GO            |                       | 4DS9-15L                | X             |   |   |
|                 | RV, EA, EB, EC    |                       | 4DS9-15                 |               | X | X |
|                 | RV, EA, EB, EC    |                       | 4DS9-15L                |               | X | X |
|                 | CCS               |                       | 4DS9-15, 15S            |               |   | X |

(C)

(D)

(D)

|   |                |  |          |
|---|----------------|--|----------|
| 9 | LO, GO         |  | 4DS6-44  |
|   | LO, GO         |  | 4DS6-44L |
|   | RV, EA, EB, EC |  | 4DS6-44  |
|   | RV, EA, EB, EC |  | 4DS6-44L |
|   | CCS            |  | 4DS6-44  |

OF KENTUCKY  
EFFECTIVE

(D)

MAY 23 1995

PURSUANT TO 807 KAR 5011,  
SECTION 9 (1)

BY: Jordan C. Neel  
FOR THE PUBLIC SERVICE COMMISSION

Issued: June 13, 1995

Effective: **May 23, 1995**

*Deborah A. Nisch* President, Cincinnati, Ohio  
Vice President  
Integrated Corporate Planning for

ACCESS SERVICE TARIFF  
PSCK No. 2

CINCINNATI BELL TELEPHONE COMPANY

1st Revised Page 177.1  
Cancels Original Page 177.1

6. Switched Access Service (Cont'd)

6.1 General (Cont'd)

6.1.3 Rate Categories (Cont'd)

(B) Switched Transport (Cont'd) (C)

(5) Interface Groups (Cont'd) (T)

(1) CCSAC Signaling Connection Premises Interface Codes

The CCSAC optional feature is provided only with Feature Group D. Feature Group D trunks are provided using Interface Groups 2, 6 and 9. CCSAC Signaling connections are provided using Interface Groups 2 and 6. Following is a matrix for Interface Groups 2, 6 and 9 showing which premises interface codes are available for signaling connections as a function of the CCSAC level of digital transmission.

(C)  
|  
(C)

| <u>Interface Groups</u> | <u>Level of Transmission</u> | <u>Premises Interface Code</u> |     |
|-------------------------|------------------------------|--------------------------------|-----|
| 2                       | DS0                          | 4N02                           | (N) |
| 6                       | DS1                          | 4DS9-15, 15S                   | (B) |
|                         |                              |                                | (D) |
|                         |                              |                                | (D) |
| 9                       | DS3                          | 4DS6-44                        | (D) |

PUBLIC SERVICE COMMISSION  
OF KENTUCKY  
EFFECTIVE

MAY 23 1995

PURSUANT TO 807 KAR 5:011,  
SECTION 9 (1)

BY: Jordan C. Neel  
FOR THE PUBLIC SERVICE COMMISSION

Issued: June 13, 1995

Effective: May 23, 1995

 President, Cincinnati, Ohio  
Vice President  
Integrated Corporate Planning for

ACCESS SERVICE TARIFF  
PSCK No, 2

CINCINNATI BELL TELEPHONE COMPANY

2nd Revised Page 178  
Cancels 1st Revised Page 178

6. Switched Access Service (Cont'd)

6.1 General (Cont'd)

6.1.3 Rate Catenaries (Cont'd)

(B) Switched Transport (Cont'd)

(C)

(6) Nonchargeable Optional Features

(T)

Where transmission facilities permit, the Telephone Company will, at the option of the customer, provide the following nonchargeable optional features in association with Switched Transport. The optional features are provided as set forth in 6.8.2(G) following.

(C)

(T)

(a) Supervisory Signaling

Where the transmission parameters permit, and where signaling conversion is required by the customer to meet its signaling capability, the customer may order an optional supervisory signaling arrangement for each transmission path provided as follows:

- For Interface Groups 1 and 2

DX Supervisory Signaling,  
E&M Type I Supervisory Signaling  
E&M Type II Supervisory Signaling, or  
E&M Type III Supervisory Signaling

- For Interface Group 2

SF Supervisory Signaling, or  
Tandem Supervisory Signaling

PUBLIC SERVICE COMMISSION  
OF KENTUCKY  
EFFECTIVE

MAY 23 1995

PURSUANT TO 807 KAR 5011,  
SECTION 9(1)

BY: Jordan C. Neel  
FOR THE PUBLIC SERVICE COMMISSION

Issued: June 13, 1995

Effective: May 23, 1995

*Deborah A. Risch*  
President, Cincinnati, Ohio  
Vice President  
Integrated Corporate Planning for

ACCESS SERVICE TARIFF  
PSCK No. 2

CINCINNATI BELL TELEPHONE COMPANY

2nd Revised Page 179  
Cancels 1st Revised Page 179

PUBLIC SERVICE COMMISSION  
OF KENTUCKY  
EFFECTIVE

6. switched Access Service (Cont'd)

6.1 General (Cont'd)

6.1.3 Rate Categories (Cont'd)

MAY 23 1995

(B) Switched Transport (Cont'd)

PURSUANT TO 807 KAR 5:011,  
SECTION 9 (1)

(C)

(6) Nonchargeable Optional Features (Cont'd)

BY: Judith C. Neul  
FOR THE PUBLIC SERVICE COMMISSION

(T)

(a) Supervisory Signaling (Cont'd)

- For Interface Groups 6 and 9

(C)

These Interface Groups may, at the option of the customer, be provided with individual transmission path SF supervisory signaling where such signaling is available in Telephone Company central offices. Generally such signaling is available only where the entry switch provides an analog, i.e., non digital digital, interface to the transport termination and a portion of the facility between the analog entry switch and the customer's premises is analog.

These optional supervisory signaling arrangements are not available in combination with the CCSAC option as specified in 6.1.3(B)(7)(a) following.

(T)

(b) Customer Specified Entry Switch Receive Level

This feature allows the customer to specify the receive transmission level at the first point of switching. The range of transmission levels which may be specified is described in Technical Reference TR-NPL-000334. This feature is available with Interface Groups 2, 6 and 9 for Feature Groups A and B.

(C)

(C)

Issued: June 13, 1995

Effective: May 23, 1995



President, Cincinnati, Ohio

Vice President  
Integrated Corporate Planning for

ACCESS SERVICE TARIFF  
PSCK No. 2

CINCINNATI BELL TELEPHONE COMPANY

2nd Revised Page 180  
Cancels 1st Revised Page 180

6. Switched Access Service (Cont'd)

6.1 General (Cont'd)

6.1.3 Rate Categories (Cont'd)

(B) Switched Transport

(C)

(6) Nonchargeable Optional Features (Cont'd)

(T)

(c) Customer Specification of Local Transport Termination

This option allows the customer to specify, for Feature Group B routed directly to an end office or access tandem, a four-wire termination of the Local Transport at the entry switch in lieu of a Telephone Company selected two-wire termination. This option is available only when the Feature Group B arrangement is provided with Type B Transmission Specifications.

(d) 64 Clear Channel Capability (64CCC)

(N)

This option allows the customer to specify 64CCC, for Feature Group D trunks equipped with Signaling System 7 (SS7) Signaling. The 64CCC option allow customers to use the Full 64 Kilobits bandwidth of a Switched digital trunk channel. This option is available where facilities are available as set forth in the Rational Exchange Carrier Association, Inc. Tariff F.C.C. No. 4.

(N)

PUBLIC SERVICE COMMISSION  
OF KENTUCKY  
EFFECTIVE

MAY 23 1995

PURSUANT TO 807 KAR 5:011,  
SECTION 9(1)

BY: Jordan C. Neel  
FOR THE PUBLIC SERVICE COMMISSION

Certain regulations previously found on this page now appear on Page 180.1.

Issued: June 13, 1995

Effective: May 23, 1995

*Deborah A. Nisch* President, Cincinnati, Ohio  
Vice President  
Integrated Corporate Planning for

ACCESS SERVICE TARIFF  
PSCK No. 2

CINCINNATI BELL TELEPHONE COMPANY

2nd Revised Page 180.1  
Cancels 1st Revised Page 180.1

6. Switched Access Service (Cont'd)

6.1 General (Cont'd)

6.1.3 Rate Categories (Cont'd)

(B) Switched Transport (Cont'd)

(T)

(7) Changeable Optional Features

(T)

(a) Common Channel Signaling Access Capability (CCSAC)

(M)(T)

This option allows the customer to receive signals for call set-up out of band. This option is only available with Feature Group D.

(M)

This option requires the establishment of signaling connections between the customer's signaling point of interconnection and the Telephone Company's designated Signaling Transfer Points (STPs). The STP locations are set forth in the National Exchange Carrier Association, Inc. Tariff P.C.C. No. 4.

(M)

PUBLIC SERVICE COMMISSION  
OF KENTUCKY  
EFFECTIVE

MAY 23 1995

PURSUANT TO 807 KAR 5.011,  
SECTION 9 (1)

BY Quinn C. Neal  
FOR THE PUBLIC SERVICE COMMISSION

The Telephone Company will provide the CCSAC option in accordance with the technical specifications set forth in Technical Reference TR-TSV-000905 from properly equipped signaling elements in the Telephone Company CCS network.

(M)

(C)

This option requires the establishment of the required number of CCSAC signaling links between the customer's signaling point of interconnection and each of the Telephone Company's designated Signaling Transfer Points (STPs) and STP Port Terminations. The STP locations are set forth in the National Exchange Carrier Association, Inc. Tariff F.C.C. No. 4. The customer will have the option of ordering a Signaling Link provisioned over a dedicated MercNet 1.544 (DS1) Facility or over a 56 Kbps DDS channel.

(C)

Certain regulations previously found on this page now appear on Page 180.2.  
Certain regulations found on this page previously appeared on Page 180.

Issued: June 13, 1995

Effective: May 23, 1995

*Deborah A. Nisich*

President, Cincinnati, Ohio

Vice President  
Integrated Corporate Planning for



ACCESS SERVICE TARIFF  
PSC No. Z

CINCINNATI 8311 TELEPHONE COMPANY

6.

Switched Access Service (Cont'd)  
6.1 General (Cont'd)

6.1.3 Rate Categories (Cont'd)

(B) Switched Transport (Cont'd)

(7) Chargeable Optional Features

(b) Signaling for Tandem Switching (Cont'd)

The customer may choose to have this option provided with Multifrequency or Common Channel Signaling.

When tandem switching is provided by a TSP, the TSP will be required to order one-way direct-trunks between the desired Telephone Company end offices and the TSP's access tandem switch. These one-way trunks will be billed as direct-trunks to the TSP.

Either the TSP or the IXC using the TSP as its access tandem provider, may be the customer for the remaining FGD usage charges, i.e., carrier common line, local switching, information surcharge and the interconnection charge. The signaling nonrecurring charge, described in Section 6.7.1(C)(4), will be assessed to the TSP. Any link between the TSP's access tandem switch and an IXC Point of Presence (POP) location may be purchased from the Telephone Company's special access section in this tariff.

If an IXC wishes to move their traffic to a TSP's access tandem switch, the TSP must provide the Telephone Company with a written letter of authorization (LOA). If a TSP contacts the Telephone Company on behalf of an IXC to move the IXC traffic from the Telephone Company access tandem switch to a TSP access tandem switch, the IXC must provide the Telephone Company an LOA.

If the IXC is the customer of record, for terminating usage, the IXC's TSP of choice is obligated to provide the Telephone Company with all billing detail needed to accurately count and bill usage. The requirements for providing this billing data are described in the following paragraphs.

(N)

(N)

6. Switched Access Service (Cont'd)

6.1 General (Cont'd)

6.1.3 Rate Categories (Cont'd)

(B) Switched Transport (Cont'd)

(7) Chargeable Optional Features

(b) Signaling for Tandem Switching (Cont'd)

(N)

Terminating Bill Detail Requirements

The TSP will be obligated to provide billing data to the Telephone Company so that minutes of use may be billed accurately and in a timely manner. Certain requirements must be met for the Telephone Company to appropriately handle and bill the TSP's usage.

- All billing information must be provided in standard Exchange Message Interface (EMI) format.
- Current call detail transmissions must be provided from the TSP to the Telephone Company on a daily basis, (excluding weekends and holidays).
- No summary billing detail will be accepted.
- Customers may transmit billing detail via Network Data Mover (NDPP) electronic data transmission or , if NDMSm is unavailable, magnetic tapes will be accepted.
- TSPs will be required to provide test data via NDM<sup>sm</sup> or magnetic tape prior to the implementation of the service.

If billing information does not meet the above requirements, the Telephone Company reserves the right to bill the total terminating switched access charges to the TSP.

(N)

6. Switched Access Service (Cont'd)

6.1 General (Cont'd)

6.1.3 Rate Categories (Cont'd)

(B) Switched Transport (Cont'd)

(7) Chargeable Optional Features

(b) Signaling for Tandem Switching (Cont'd)

(N)

Terminating Bill Detail Requirements

Resolutions of this nature could result in additional charges to the TSP. in the event extensive investigation and/or validation system development is required to reconcile discrepancies. If usage discrepancies are resolved in favor of the Telephone Company, the TSP will be responsible for payment of unbilled usage.

Signaling for tandem switching will not be available with Feature Group B; Feature Group D with 950 Access; and, 800 traffic.

(N)

ACCESS SERVICE TARIFF  
PSC No. 2

CINCINNATI BELL TELEPHONE COMPANY

1st Revised Page 180.2  
Cancels Original Page 180.2

6. Switched Access Service (Cont'd)  
6.1 General (Cont'd)  
6.1.3 Rate Categories (Cont'd)  
(C) Local Switching

This rate category provides for (1) local end office switching, i.e., the common switching functions associated with the various Switched Access Service arrangements, (2) the termination of Switched transport at end offices, (3) the termination of common lines and WATS Access Lines at end offices, (4) intercept functions, i.e., the termination of certain calls at a Telephone Company intercept operator or recording and (5) 800 Data Base Queries. This category includes usage sensitive rates and both chargeable and non-chargeable optional features.

- (1) Usage Sensitive Rates - The usage sensitive rates are applied as follows:

- (a) (D)
- (b) Local Switching applies on a per minute of use basis, providing local switching functions for FGA, FGB, FGD, 500, 800, and 900 Access Service. Where end offices are appropriately equipped, international dialing may also be provided as a capability of local switching, i.e., the capability of switching international calls with service prefix and address codes having more digits than can be switched through a standard FGD end office. (T)
- (c) 800 Access Service Data Base Query Charge and Routing Options Capability apply on a per query basis and are originating offerings utilizing FGD. These services provide customer identification and additional call handling and destination features (i.e., time of day, day of week, etc.). (T)

The application of these rates is set forth in 6.7.1(D) following.

- (2) optional Features - Various Common Switching, Transport Termination and WATS Access Line Termination optional features are available and are described in 6.3 following.

ACCESS SERVICE TARIFF  
PSCK No. 2

CINCINNATI BELL TELEPHONE COMPANY

1st Revised Page 181  
Cancels Original Page 181

6. Switched Access Service (Cont'd)

6.1 General (Cont'd)

6.1.4 Special Facilities Routing

Any customer may request that the facilities used to provide Switched Access Service be specially routed. The regulations, rates and charges for Special Facilities Routing (i.e., Avoidance, Diversity and Cable-Only) are set forth in 11. following.

6.1.5 Design Layout Report

At the request of the customer, the Telephone Company will provide to the customer the makeup of the facilities and services provided from the customer's premises to the first point of switching. This information will be provided in the form of a Design Layout Report. The Design Layout Report will be provided to the customer at no charge, and will be reissued or updated whenever these facilities are materially changed.

6.1.6 Acceptance Testing

At no additional charge, the Telephone Company will, at the time of installation of Feature Group D with the 64CCC Switched Transport option trunks, perform the Digital Trunk Acceptance Tests described in TR-TSV-000905.

(N)  
|  
(N)

PUBLIC SERVICE COMMISSION  
OF KENTUCKY  
EFFECTIVE

MAY 23 1995

PURSUANT TO 807 KAR 5.011,  
SECTION 9 (1)  
BY: Jordan C. Neal  
FOR THE PUBLIC SERVICE COMMISSION

Issued: June 13, 1995

Effective: May 23, 1995

  
Deborah A. Nisch, President, Cincinnati, Ohio  
Vice President  
Integrated Corporate Planning for

ACCESS SERVICE TARIFF  
PSCK No. 2

CINCINNATI BELL TELEPHONE COMPANY

2nd Revised Page 182  
Cancels 1st Revised Page 182

6. Switched Access Service (Cont'd)

6.1 General (Cont'd)

6.1.7 Ordering Options and Conditions

**Switched** Access Service is ordered under the Access Order provisions set forth in Section 5 (Ordering options For **Switched** and **Special Access**). For **Switched Transport**, ordering provisions as set forth in 2.4.8 (**Billing of Access Service Provided by Multiple Companies**) will apply when more than one Exchange Telephone Company is involved in the provision of a **Switched Transport Facility**. Rate elements for **Switched Access Services** are defined in 6.8.

(C)  
|  
(C)

6.1.8 CCSAC Testing Requirements

When Feature Group D with CCSAC option is ordered, network compatibility and other operational tests will be performed cooperatively by the Telephone Company and the customer. These tests are as specified in Technical Reference TR-TSV-000905.

PUBLIC SERVICE COMMISSION  
OF KENTUCKY  
EFFECTIVE

MAY 23 1995

PURSUANT TO 807 KAR 5:011,  
SECTION 9(1)

BY: Jordan C. Neel  
FOR THE PUBLIC SERVICE COMMISSION

Issued: **June** 13, 1995

Effective: **May** 23, 1995

Deborah A. Nisch President, Cincinnati, Ohio

Vice President  
Integrated Corporate Planning for

6. Switched Access Service (Cont'd)

6.2 Provision and Description of Switched Access Service Feature Groups

Switched Access Service is provided in three different Feature Group arrangements. The provision of each Feature Group requires switched transport facilities and the appropriate end office functions. There are various optional features available with the Feature Groups. The Switched Transport, Common Switching and Transport Termination optional features are available at all Telephone Company end office switches, unless stated otherwise. In addition, WATS Access Line Service as described in 7.2.3 following may, at the option of the customer, be provided for use with Feature Groups A, B and D. WATS Access Line Termination optional features are available in end offices designated as WATS Serving Offices.

There are three specific transmission specifications (i.e., Types A, B and C) that have been identified for the provision of Feature Groups. The specifications provided are dependent on the Interface Group and the routing of the service, i.e., whether the service is routed directly to the end office or via an access tandem. The parameters for the transmission specifications are set forth in 6.4.1 following.

Feature Groups are arranged for either originating, terminating or two-way calling, based on the customer end office switching capacity ordered. Originating calling permits the delivery of calls from Telephone Exchange Service locations to the customer's premises. Terminating calling permits the delivery of calls from the customer's premises to Telephone Exchange Service locations. Two-way calling permits the delivery of calls in both directions, but not simultaneously. The Telephone Company will determine the type of calling to be provided unless the customer requests that a different type of directional calling is to be provided. In such cases, the Telephone Company will work cooperatively with the customer to determine the directionality.

Following are detailed descriptions of each of the available Feature Groups. Each Feature Group is described in terms of its specific physical characteristics and calling patterns, the transmission specifications with which it is provided, the optional features available for use with it and the standard testing capabilities.

PUBLIC SERVICE COMMISSION  
OF KENTUCKY  
EFFECTIVE

MAY 23 1995

PURSUANT TO 807 KAR 5.011,  
SECTION 9(1)

BY: Jordan C. Neel  
FOR THE PUBLIC SERVICE COMMISSION

Issued: June 13, 1995

Effective: May 23, 1995

Deborah A. Nisch President, Cincinnati, Ohio  
Vice Presiden:  
Integrated Corporate Planning for

ACCESS SERVICE TARIFF  
PSC No. 2

CINCINNATI BELL TELEPHONE COMPANY

Original Page 184

6. Switched Access Service (Cont'd)

6.2 Provision and Description of Switched Access Service Feature Groups (Cont'd)

6.2.1 Feature Group A (FGA)

(A) Description

- (1) FGA is provided in connection with Telephone Company electronic and electromechanical end offices. At the option of the customer, FGA is provided on a single or multiple line group basis and is arranged for originating calling only, terminating calling only, or two-way calling.
- (2) FGA provides a line side termination at the first point of switching. The line side termination will be provided with either ground start supervisory signaling or loop start supervisory signaling. The type of signaling is at the option of the customer.
- (3) The Telephone Company shall select the first point of switching, within the selected LATA, at which the line side termination is to be provided unless the customer requests a different first point of switching and Telephone Company facilities and measurement capabilities, are available to accommodate such a request.

PUBLIC SERVICE COMMISSION  
OF KENTUCKY  
EFFECTIVE

MAR 3 1992

PURSUANT TO 807 KAR 5:011,  
SECTION 9 (1)

BY: *[Signature]*

Effective: *[Signature]* March 3, 1992

Issued: February 7, 1992

*Robert E. Aigmon* for President, Cincinnati, Ohio

Vice President - Regulatory Affairs



6. Switched Access Service (Cont'd)

6.2 Provision and Description of Switched Access Service Feature Groups  
(Cont'd)

6.2.1 Feature Group A (FGA)

(A) Description (Cont'd)

(4) A seven digit local telephone number assigned by the Telephone Company is provided for access to FGA switching in the originating direction. The seven digit local telephone number will be associated with the selected end office switch and is of the form NXX-XXXX.

If the customer requests a specific seven digit telephone number that is not currently assigned, and the Telephone Company can, with reasonable effort, comply with that request, the requested number will be assigned to the customer.

PUBLIC SERVICE COMMISSION  
OF KENTUCKY  
EFFECTIVE

MAR 3 1992

PURSUANT TO 807 KAR 5:011 .  
SECTION 9 (1)

BY: Sharon Helle  
PUBLIC SERVICE COMMISSION MANAGER

Issued: February 7, 1992

Effective: March 3, 1992

Robert E. Sigmon for President, Cincinnati, Ohio

Vice President - Regulatory Affairs

ACCESS SERVICE TARIFF  
PSC No. 2

CINCINNATI BELL TELEPHONE COMPANY

1st Revised Page 186  
Cancels Original Page 186

6. Switched Access Service (Cont'd)

6.2 Provision and Description of Switched Access Service Feature Groups  
(Cont'd)

6.2.1 Feature Group A (FGA) (Cont'd)

(A) Description (Cont'd)

(5) FGA switching, when used in the terminating direction, is arranged with dial tone start-dial signaling. When used in the terminating direction FGA switching may, at the option of the customer, be arranged for dial pulse or dual tone multifrequency address signaling, subject to availability of equipment at the first point of switching. When FGA switching is provided in a hunt group or uniform call distribution arrangement, all FGA switching will be arranged for the same type of address signaling.

PUBLIC SERVICE COMMISSION:  
OF KENTUCKY (6)  
EFFECTIVE

No address signaling is provided by the Telephone Company when FGA Switching is used in the originating direction. Address signaling in such cases, if required by the customer, must be provided by the customer's end user using inband tone signaling techniques. Such inband tone address signals will not be regenerated by the Telephone Company and will be subject to the ordinary transmission capabilities of the Switched Transport provided. (C)

MAY 23 1995

PURSUANT TO 807 KAR 5.011,  
SECTION 9(1)

BY: Jordan C. Neel  
FOR THE PUBLIC SERVICE COMMISSION

(7) FGA switching, when used in the terminating direction, may be used to access valid NXXs in the LATA, local operator service (0- and 0+), Directory Assistance (555-1212), emergency reporting service (911 where available), exchange telephone repair (611 where available), time or weather announcement services of the Telephone Company, community information services of an information service provider, and other customers' services (by dialing the appropriate digits). Effective June 30, 1988, FGA service will be equipped on new installations with the Common Switching Optional Feature of Call Denial. If Call Denial is not desired, the customer must so specify at the time service is requested. Charges for FGA terminating calls requiring operator assistance or calls to 611 or 911 will only apply where sufficient call details are available. Additional non-access charges will also be billed on a separate account for (1) an operator surcharge, as set forth in the local exchange tariffs, for local operator assistance (0- and 0+) calls, (2) calls to certain

Issue . 1995  
W. Neel

Effective: May 23, 1995

Vice President  
Integrated Corporate Planning for

President, Cincinnati, Ohio

ACCESS SERVICE TARIFF  
PSC No. 2

CINCINNATI BELL TELEPHONE COMPANY

Original Page 187

6. Switched Access Service (Cont'd)

6.2 Provision and Description of Switched Access Service Feature Groups  
(Cont'd)

6.2.1 Feature Group A (FGA) (Cont'd)

(A) Description (Cont'd)

(7) (Cont'd)

community information services, for which rates are applicable under Telephone Company exchange service tariffs, e.g., 976 (DIAL-IT) Network services, and (3) calls from a FGA line to another customer's service in accordance with that customer's applicable service rates when the Telephone Company performs the billing function for that customer. For FGA calls to Directory Assistance (555-1212), Switched Access Service usage rates will not apply. Instead, FGA calls to this service are subject to Directory Assistance Service per call rates as set forth in 9.6(A) and (B) following.

(8) When a FGA switching arrangement for an individual customer (a single line or entire hunt group) is discontinued at an end office, an intercept announcement is provided. This arrangement provides, for a limited period of time, an announcement that the service associated with the number dialed has been disconnected and, if desired, reference to another number.

(B) Optional Features

(1) Common Switching Optional Features

- (a) Hunt Group Arrangement
- (b) Uniform Call Distribution Arrangement
- (c) Nonhunting Number for Use with Hunt Group Arrangement or Uniform Call Distribution Arrangement
- (d) Call Denial
- (e) Service Code Denial

**PUBLIC SERVICE COMMISSION  
OF KENTUCKY  
EFFECTIVE**

MAR 3 1992

**PURSUANT TO 807 KAR 5:011,**

Issued: February 7, 1992

Effective: SECTION 9 (1)  
March 3, 1992

*Robert E. Aigmon* for President, Cincinnati, Ohio

BY: *[Signature]*  
PUBLIC SERVICE COMMISSION MANAGER

Vice President - Regulatory Affairs

ACCESS SERVICE TARIFF  
PSCK No. 2

CINCINNATI BELL TELEPHONE COMPANY

Original Page 188

6. Switched Access Service (Cont'd)

6.2 Provision and Description of Switched Access Service Feature Groups  
(Cont'd)

6.2.1 Feature Group A (FGA) (Cont'd)

(B) Optional Features (Cont'd)

(1) Common Switching Optional Features (Cont'd)

- (f) Band Advance Arrangement for Use with WAIS Access Line Service
- (g) Hunt Group Arrangement for Use with WAIS Access Line Service
- (h) Uniform Call Distribution Arrangement for Use with WAIS Access Line Service
- (i) Nonhunting Number for Use with Hunt Group Arrangement or Uniform Call Distribution Arrangement for use with WAIS Access Line Service
- (j) 900/700/976 Call Blocking

PUBLIC SERVICE COMMISSION  
OF KENTUCKY  
EFFECTIVE

MAR 3 1992

PURSUANT TO 807 KAH 5:011,  
SECTION 9 (1)

BY: 

Effective:  March 3, 1992

Issued: February 7, 1992

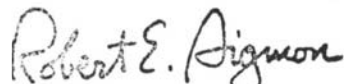
 for President, Cincinnati, Ohio

Vice President - Regulatory Affairs

ACCESS SERVICE TARIFF  
PSC No. 2

CINCINNATI BELL TELEPHONE COMPANY

1st Revised Page 189  
Cancels Original Page 189

6. Switched Access Service (Cont'd)

6.2 Provision and Description of Switched Access Service Feature Groups  
(Cont'd)

6.2.1 Feature Group A (FGA) (Cont'd)

(B) Optional Feature (Cont'd)

(2) Transport Termination Optional Features

- (a) Two-way operation with dial pulse address signaling and loop start supervisory signaling
- (b) Two-way operation with dial pulse address signaling and ground start supervisory signaling
- (c) Two-way operation with dual tone multi-frequency address signaling and loop start supervisory signaling
- (d) Two-way operation with dual tone multi-frequency address signaling and ground start supervisory signaling
- (e) Terminating operation with dial pulse address signaling and loop start supervisory signaling
- (f) Terminating operation with dial pulse address signaling and ground start supervisory signaling
- (g) Terminating operation with dual tone multi-frequency address signaling and loop start supervisory signaling
- (h) Terminating operation with dual tone multi-frequency address signaling and ground start supervisory signaling
- (i) Originating operation with loop start supervisory signaling
- (j) Originating operation with ground start supervisory signaling

(3) Switched Transport Operational Features

- (a) Supervisory Signaling (as set forth in 6.1.3(B)(6)(a) preceding)
- (b) Customer Specified Entry Switch Receive Level

PUBLIC SERVICE COMMISSION  
OF KENTUCKY  
EFFECTIVE  
MAY 23 1995  
MAY 23 1995  
PURSUANT TO 807 KAR 5.011  
SECTION 9(1)  
BY: Joseph C. Neal  
FOR THE PUBLIC SERVICE COMMISSION

Issued: **June 13, 1995**

Effective: **May 23, 1995**

President, Cincinnati, Ohio  
*Sarah A. Nisch*  
Vice President  
Integrated Corporate Planning for

ACCESS SERVICE TARIFF  
PSC No. 2

CINCINNATI BELL TELEPHONE COMPANY

1st Revised Page 190  
Cancels Original Page 190

6. Switched Access Service (Cont'd)

6.2 Provision and Description of Switched Access Service Feature Groups  
(Cont'd)

6.2.1 Feature Group A (FGA) (Cont'd)

(B) Optional Feature (Cont'd)

(4) Certain other features which may be available in connection with Feature Group A, such as Custom Calling Features and IntraLATA extensions, are provided under the Telephone Company's Local and/or general exchange service tariffs.

(C) Transmission Specifications

FGA is provided with either Type B or Type C Transmission Specifications. The specifications for the associated parameters are guaranteed to the first point of switching. Type C Transmission Specifications are provided with Interface Group 1 and Type B is provided with Interface Groups 2, 6 and 9. Type DB Data Transmission Parameters (C) are provided with FGA to the first point of switching.

(D) Testing Capabilities

FGA is provided, in the terminating direction where equipment is available, with seven digit access to balance (100 type) test line and milliwatt (102 type) test line. In addition to the tests described in 6.1.6 preceding which are included with the installation of service, additional Cooperative Acceptance Testing and Nonscheduled Testing are available for FGA as set forth in 13.3.5 following.

PUBLIC SERVICE COMMISSION  
OF KENTUCKY  
EFFECTIVE

MAY 23 1995  
PURSUANT TO 807 KAR 5.011,  
SECTION 9(1)  
BY: Jordan C. Neal  
FOR THE PUBLIC SERVICE COMMISSION

Issued: June 13, 1995

Effective: May 23, 1995

  
President, Cincinnati, Ohio  
Vice President  
Integrated Corporate Planning for

6. Switched Access Service (Cont'd)

6.2 Provision and Description of Switched Access Service Feature Groups (Cont'd)

6.2.2 Feature Group B (FGB)

(A) Description

- (1) FGB, when directly routed to an end office (i.e., provided without the use of an access tandem switch), is provided at appropriately equipped Telephone Company electronic end office switches. When provided via Telephone Company designated electronic access tandem switches, FGB switching is provided at all Telephone Company end office switches.
- (2) FGB is provided as trunk side switching through the use of end office or access tandem switch trunk equipment. The switch trunk equipment is provided with wink start start-pulsing signals and answer and disconnect supervisory signaling.
- (3) FGB switching is provided with multifrequency address signaling in both the originating and terminating directions. Except for FGB switching provided with the automatic number identification (ANI) or rotary dial station signaling arrangements as set forth in 6.3 following, any other address signaling in the originating direction, if required by the customer, must be provided by the customer's end user using inband tone signaling techniques. Such inband tone address signals will not be regenerated by the Telephone Company and will be subject to the ordinary transmission capabilities of the Local Transport provided.
- (4) The access code for FGB switching is a uniform access code. The form of the uniform access code is 950-1XXX. These uniform access codes will be the assigned access numbers of all FGB Switched Access Service provided to the customer by the Telephone Company. (T)

6. Switched Access Service (Cont'd)

6.2 Provision and Description of Switched Access Service Feature Groups  
(Cont'd)

6.2.2 Feature Group B (FGB) (Cont'd)

(A) Description (Cont'd)

- (5) FGB switching, when used in the terminating direction, may be used to access Telephone Company specified NXXs in the LATA, time or weather announcement services of the Telephone Company, community information services of an information service provider and other customers' services (by dialing the appropriate digits). When directly routed to an end office, only those valid NXX codes served by that end office may be accessed. When routed through an access tandem, only those valid NXX codes served by end offices subtending the access tandem may be accessed. The customer will also be billed additional non-access charges for calls to certain community information services for which rates are applicable under Telephone Company exchange service tariffs, e.g., 976 (DIAL-IT) Network Service. Additionally, non-access charges will also be billed for calls from a FGB trunk to another customer's service in accordance with that customer's applicable service rates when the Telephone Company performs the billing function for that customer. Calls in the terminating direction will not be completed to 950-XXXX access codes, local operator assistance (0- and 0+), Directory Assistance (555-1212), service codes 611 and 911, 10XXX, or 101-XXXX access codes. Calls will be completed to (C) Directory Assistance (NPA-5551212 or 555-1212) when FGB switching is combined with Directory Assistance switching. The combination of FGB Switched Access Service with DA service is provided as set forth in 9. following. FGB may not be switched, in the terminating direction, to Switched Access Service Feature Groups B or D.



ACCESS SERVICE TARIFF  
PSCK NO. 2

CINCINNATI BELL TELEPHONE COMPANY

1st Revised Page 193  
Cancels **Original** Page 193

6. Switched Access Service (Cont'd)

6.2 Provision and Description of Switched Access Service Feature Groups  
(Cont'd)

6.2.2 Feature Group B (FGB) (Cont'd)

---

Telephone Switching Office (MTSO) interconnected to a Telephone Company access tandem, the customer will be assessed charges only from the customer's point of presence to the access tandem. Entrance Facility Charges, Tandem-Switched Transmission charges, Tandem Switching Charges and an Interconnection

PUBLIC SERVICE COMMISSION  
OF KENTUCKY  
EFFECTIVE

MAY 23 1995

PURSUANT TO 807 KAR 5:011,  
SECTION 9(1)

BY: Jordan C. Neal  
FOR THE PUBLIC SERVICE COMMISSION

---

Issued: **June** 13, 1995

Effective: **May** 23, 1995

*Deborah A. Nisich* President, Cincinnati, Ohio  
Vice President  
Integrated Corporate **Planning** for

6. Switched Access Service (Cont'd)

6.2 Provision and Description of Switched Access Service Feature Groups  
(Cont'd)

6.2.2 Feature Group B (FGB) (Cont'd)

(A) Description (Cont'd)

- (7) When all FGB switching arrangements are discontinued at an end office and/or in a LATA, an intercept announcement is provided. This arrangement provides, for a limited period of time, an announcement that the service associated with the number dialed has been discontinued.

(B) Optional Features

(1) Common Switching Optional Features

PUBLIC SERVICE COMMISSION  
OF KENTUCKY  
EFFECTIVE

MAY 23 1995

PURSUANT TO 807 KAR 5.011,  
SECTION 9 (1)

BY: Jordan C. Neal  
FOR THE PUBLIC SERVICE COMMISSION

- (a) Automatic Number Identification (ANI)  
(b) Up to 7 Digit Outpulsing of Access Digits to Customer  
(c) Alternate Traffic Routing  
(d) Band Advance Arrangement for Use with WATS Access Line Service  
(e) Hunt Group Arrangement for Use with WATS Access Line Service  
(f) Uniform Call Distribution Arrangement for Use with WATS Access Line Service  
(g) Nonhunting Number for Use with Hunt Group Arrangement or Uniform Call Distribution Arrangement for Use with WATS Access Line Service

(2) Transport Termination Optional Features

- (a) Rotary Dial Station Signaling

(3) Switched Transport Optional Features

- (a) Customer Specification of Switched Transport Termination (C)  
(b) Supervisory Signaling (as set forth in 6.1.3(B)(6)(a) preceding) (T)  
(c) Customer Specified Entry Switch Receive Level

Issued: June 13, 1995

Effective: May 23, 1995

*Deborah A. Nisch*  
President, Cincinnati, Ohio  
Vice President  
Integrated Corporate Planning for

ACCESS SERVICE TARIFF  
PSCK No. 2

CINCINNATI BELL TELEPHONE COMPANY

1st Revised Page 195  
Cancels Original Page 195

6. Switched Access Service (Cont'd)

6.2 Provision and Description of Switched Access Service Feature Groups  
(Cont'd)

6.2.2 Feature Group B (FGB) (Cont'd)

(C) Transmission Specifications

FGB is provided with either Type B or Type C Transmission Specifications. The specifications for the associated parameters are guaranteed to the end office when routed directly or to the first point of switching when routed via an access tandem. Type C Transmission Specifications are provided with Interface Group 1 and Type B is provided with Interface Groups 2, 6 and 9. Type DB Data Transmission Parameters are provided with FGB to the first point of switching. (C)

(D) Testing Capabilities

FGB is provided, in the terminating direction where equipment is available, with seven digit access to balance (100 type) test line, milliwatt (102 type) test line, nonsynchronous or synchronous test line, automatic transmission measuring (105 type) test line, data transmission (107 type) test line, loop around test line, short circuit test line and open circuit test line. In addition to the tests described in 6.1.6 preceding which are included with the installation of service, additional Cooperative Acceptance Testing, Automatic Scheduled Testing, Cooperative Scheduled Testing, Manual Scheduled Testing and Nonscheduled Testing are available as set forth in 13.3.5 following.

6.2.3 Reserved

PUBLIC SERVICE COMMISSION  
OF KENTUCKY  
EFFECTIVE

MAY 23 1995

PURSUANT TO 807 KAR 5:011,  
SECTION 9(1)

BY: Jordan C. Neal  
FOR THE PUBLIC SERVICE COMMISSION

Issued: June 13, 1995

Effective: May 23, 1995

Deborah A. Niseb President, Cincinnati, Ohio  
Vice President  
Integrated Corporate Planning for

ACCESS SERVICE TARIFF  
PSCK No. 2

CINCINNATI BELL TELEPHONE COMPANY

2nd Revised Page 196  
Cancels 1st Revised Page 196

6. Switched Access Service (Cont'd)

6.2 Provision and Description of Switched Access Service Feature Groups  
(Cont'd)

6.2.4 Feature Group D (FGD)

(A) Description

- (1) FGD is provided at Telephone Company designated electronic end office switches whether routed directly or via Telephone Company designated electronic access tandem switches.

For Feature Group D with CCSAC, the CCSAC option is provided through Telephone Company-designated STPs.

- (2) FGD is provided as trunk side switching through the use of end office or access tandem switch trunk equipment. The switch trunk equipment may be provided with wink start start-pulsing signals and answer and disconnect supervisory signaling, or, without signaling when the CCSAC optional feature is specified.

PUBLIC SERVICE COMMISSION (3)  
OF KENTUCKY  
EFFECTIVE

MAY 23 1995

PURSUANT TO 807 KAR 5.011,  
SECTION 9 (1)

BY: Jordan C. Neal  
FOR THE PUBLIC SERVICE COMMISSION

FGD switching is provided with multifrequency address signaling or common channel signaling. Up to 12 digits of the called party number dialed by the customer's end user using dual tone multi-frequency or dial pulse address or common channel (out-of-band) signals will be provided by Telephone Company equipment to the customer's premises where the Switched Access Service terminates. Such address signals will be subject to the ordinary transmission capabilities of the Switched Transport provided. (C)

- (4) FGD switching, when used in the terminating direction, may be used to access valid NXXs in the LATA, time or weather announcement services of the Telephone Company, community

Issued: June 13, 1995

Effective: May 23, 1995

  
Deborah A. Nisch, President, Cincinnati, Ohio  
Vice President  
Integrated Corporate Planning for

6. Switched Access Service (Cont'd)

6.2 Provision and Description of Switched Access Service Feature Groups (Cont'd)

6.2.4 Feature Group D (FGD) (Cont'd)

(A) Description (Cont'd)

(4) (Cont'd)

information services of an information service provider, and other customers' services (by dialing the appropriate codes) when such services can be reached using valid NXX codes. When directly routed to an end office, only those valid NXX codes served by that office may be accessed. When routed through an access tandem, only those valid NXX codes served by end offices subtending the access tandem may be accessed. The customer will also be billed additional non-access charges for calls to certain community information services, for which rates are applicable under Telephone Company exchange service tariffs, e.g., 976 (DIAL-IT) Network Service. Additionally, non-access charges will also be billed for calls from a FGD trunk to another customer's service in accordance with that customer's applicable service rates when the Telephone Company performs the billing function for that customer. Calls in the terminating direction will not be completed to 950-XXXX access codes, local operator assistance (0- and 0+), Directory Assistance (411 and 555-1212), service codes 611 and 911, 10XXX, and 101-XXXX access codes, Calls will be completed to Directory Assistance (NPA-555-1212 or 555-1212) when FGD switching is combined with Directory Assistance switching. The combination of FGD Switched Access Service with DA Service is provided as set forth in 9. following. FGD may not be switched, in the terminating direction, to Switched Access Service Feature Groups B or D.

(C)

- (5) The Telephone Company will establish a trunk group or groups for the customer at end office switches or access tandem switches where FGD switching is provided. When required by technical limitations, a separate trunk group will be established for each type of FGD switching arrangement provided. Different types of FGD or other switching arrangements may be combined in a single trunk group at the option of the Telephone Company.

ACCESS SERVICE TARIFF  
PSCK No. 2

CINCINNATI BELL TELEPHONE COMPANY

2nd Revised Page 198  
Cancels 1st Revised Page 198

6. Switched Access Service (Cont'd)

6.2 Provision and Description of Switched Access Service Feature Groups  
(Cont'd)

6.2.4 Feature Group D (FGD) (Cont'd)

(A) Description (Cont'd)

- (6) The access code for FGD switching is a uniform access code of the form 10XXX or 101-XXXX. These uniform access codes will be the assigned access numbers of all FGD access provided to the customer by the Telephone Company. In addition, when the customer elects the FGD with 950 Access optional feature described in 6.3.1(X) following, FGD calls may also be originated using the customer's 950-XXXX access code. No access code is required for calls to a customer over FGD Switched Access Service if the end user's telephone exchange service is arranged for presubscription to that customer, as set forth in 13. following. (C)

Where no access code is required, the number dialed by the customer's end user shall be a seven or ten digit number for calls in the North American Numbering Plan (NANP). For international calls outside the NANP, a seven to twelve digit number may be dialed. The form of the numbers dialed by the customer's end user is 0 or 1 + NXX-XXXX, 0 or 1 + NPA + NXX-XXXX, and, when the end office is equipped for International Direct Distance Dialing (IDDD), 01+ CC + NN or 011 + CC + NN.

When the 10XXX or 101-XXXX access code is used, FGD switching also provides access to a variety of services available through the customer's system or at the customer's option, the end-of-dialing digit (#) for cut-through access to the customer's premises. (C)

- (7) FGD switching will be arranged to accept calls from telephone exchange service locations without the need for dialing the 10XXX or 101-XXXX uniform access code. Each telephone exchange service line may be marked with a presubscription code to identify which 10XXX or 101-XXXX code its calls will be directed to for (C) interLATA service. Presubscription codes are applied as set forth in 13. following. (C)

ACCESS SERVICE TARIFF  
PSCK No. 2

CINCINNATI BELL TELEPHONE COMPANY

1st Revised Page 199  
Cancels *Original* Page 199

6. Switched Access Service (Cont'd)

6.2 Provision and Description of Switched Access Service Feature Groups  
(Cont'd)

6.2.4 Feature Group D (FGD) (Cont'd)

(A) Description (Cont'd)

- (8) When a customer has had FGB access in an end office and subsequently replaces the FGB access with FGD access, the Telephone Company will, for a period of up to 90 days, direct calls dialed by the customer's end users using the customer's previous FGB access code to the customer's FGD access service. The customer must be prepared to handle normally dialed FGD calls as well as calls dialed with the FGB access code which require the customer to receive additional address signaling from the end user. Such calls will be rated as FGD.

of presence to the access tandem. Entrance Facility charges, Tandem-Switched Transmission charges,

PUBLIC SERVICE COMMISSION  
OF KENTUCKY  
EFFECTIVE

MAY 23 1995

PURSUANT TO 807 KAR 5:011,  
SECTION 9(1)

BY: Jordan C. Neal  
FOR THE PUBLIC SERVICE COMMISSION

Issued: **June** 13, 1995

Effective: **May** 23, 1995

\* P sident, Cincinnati, Ohio

Vice President  
Integrated Corporate Planning for

ACCESS SERVICE TARIFF  
PSCK No. 2

CINCINNATI BELL TELEPHONE COMPANY

2nd Revised Page 200  
Cancels 1st Revised Page 200

6. Switched Access Service (Cont'd)

6.2 Provision and Description of Switched Access Service Feature Groups  
(Cont'd)

6.2.4 Feature Group D (FGD) (Cont'd)

(B) Optional Features

(1) Common Switching Optional Features

- (a) Automatic Number Identification (ANI) and Flexible Automatic Number Identification (FLEX ANI)
- (b) Service Class Routing
- (c) Alternate Traffic Routing
- (d) Call Gaping Arrangement
- (e) Trunk Access Limitation
- (f) International Carrier Option
- (g) End Office End User Line Service Screening for Use with WATS Access Line Service
- (h) Hunt Group Arrangement for Use with WATS Access Line Service
- (i) Uniform Call Distribution Arrangement for Use with WATS Access Line Service
- (j) Nonhunting Number for Use with Hunt Group Arrangement or Uniform Call Distribution Arrangement for Use with WATS Access Line Service
- (k) Band Advance Arrangement for Use with WATS Access Line Service
- (l) Cut-Through
- (m) Feature Group D with 950 Access
- (n) Calling Party Number (CPN)
- (o) Charge Number (CN)
- (p) Carrier Selection Parameter (CSP)

MAY 23 1995

PURSUANT TO 807 KAR 5.011,  
SECTION 9(1)

BY: *Jordan C. Neal*  
PUBLIC SERVICE COMMISSION  
OF KENTUCKY  
EFFECTIVE

(2) Transport Termination Optional Features

- (a) Operator Trunk, Full Feature Arrangement

(3) Switched Transport Optional Features

- (a) Supervisory Signaling (as set forth in 6.1.3(B)(6)(a) preceding) (T)
- (b) Common Channel Signaling Access Capability (CCSAC) as set forth in 6.1.3(B)(7)(a) preceding.
- (c) 64CCC as set forth in 6.1.3(B)(6)(d) preceding. (19)

Issued: June 13, 1995

Effective: May 23, 1995

*Deborah L. Nisch*

Vice President  
Integrated Corporate Planning for

President, Cincinnati, Ohio



ACCESS SERVICE TARIFF  
PSCK No. 2

CINCINNATI BELL TELEPHONE COMPANY

1st Revised Page 201  
Cancels Original Page 201

6. Switched Access Service (Cont'd)

6.2 Provision and Description of Switched Access Service Feature Groups  
(Cont'd)

6.2.4 Feature Group D (FGD) (Cont'd)

(C) Transmission Specifications

FGD is provided with either Type A, Type B or Type C Transmission Specifications as follows:

- When routed directly to the end office either Type B or C is provided.
- When routed to an access tandem only Type A is provided.
- Type A is provided on the transmission path from the access tandem to the end office.

Type C Transmission Specifications are provided with Interface Group 1. Type A and Type B Transmission Specifications are provided with Interface Groups 2, 6 and 9. (C)

Type DA Data Transmission Parameters are provided for the transmission path between the customer's premises and the access tandem and between the access tandem and the end office. Type DB Data Transmission Parameters are provided with FGD for the transmission path between the customer's premises and the end office when directly routed to the end office.

PUBLIC SERVICE COMMISSION  
OF KENTUCKY  
EFFECTIVE

MAY 23 1995

PURSUANT TO 807 KAR 5011,  
SECTION 9(1)

BY: Jordan C. Neel  
FOR THE PUBLIC SERVICE COMMISSION

Issued: **June 13, 1995**

Effective: **May 23, 1995**

  
President, Cincinnati, Ohio  
Vice President  
Integrated Corporate Planning for

6. Switched Access Service (Cont'd)

6.2 Provision and Description of Switched Access Service Feature Groups  
(Cont'd)

6.2.4 Feature Group D (FGD) (Cont'd)

(D) Testing Capabilities

FGD is provided, in the terminating direction where equipment is available, with seven digit access to balance (100 type) test line, milliwatt (102 type) test line, nonsynchronous or synchronous test line, automatic transmission measuring (105 type) test line, data transmission (107 type) test line, loop around test line, short circuit test line and open circuit test line. In addition to the tests described in 6.1.6 preceding which are included with the installation of service, additional Cooperative Acceptance Testing, Automatic Scheduled Testing, Cooperative Scheduled Testing, Manual Scheduled Testing, and Nonscheduled Testing, are available for FGD as set forth in 13.3.5 following.

6.3 Local Switching Optional Features

Following are descriptions of the various optional features that are available in lieu of, or in addition to, the standard features provided with the Feature Groups.

6.3.1 Common Switching

(A) Call Denial on Line or Hunt Group

This option allows for the screening of terminating calls within the LATA, and for the completion only of calls to 611, 911, 800, 555-1212, and a Telephone Company specified set of NXXs within the Telephone Company local exchange calling area of the dial tone office in which the arrangement is provided. All other "toll" calls are routed to a reorder tone or recorded announcement. This feature is provided in all Telephone Company electronic end offices and, where available, in electromechanical end offices. It is available with Feature Group A. Call Denial, Service Code Denial and 900/700/976 Call Blocking are mutually exclusive.

MAR 3 1992

PURSUANT TO 807 KAR 5:011,  
SECTION 9 (1)

Issued: February 7, 1992

BY: *Shawn Deller*  
Effective: March 3, 1992  
PUBLIC SERVICE COMMISSION MANAGER

*Robert E. Sigmon* for President, Cincinnati, Ohio

Vice President - Regulatory Affairs

ACCESS SERVICE TARIFF  
PSCK No. 2

CINCINNATI BELL TELEPHONE COMPANY

Original Page 203

6. Switched Access Service (Cont'd)

6.3 Local Switching Optional Features (Cont'd)

6.3.1 Common Switching (Cont'd)

(B) Service Code Denial on Line or Hunt Group

This option allows for the screening of terminating calls within the LATA, and for disallowing completion of calls to 0- and N11 (e.g., 611, and 911). This feature is provided where available in all Telephone Company electronic end offices and electromechanical end offices. It is available with Feature Group A. Service Code Denial, Call Denial and 900/700/976 Call Blocking are mutually exclusive.

(C) Hunt Group Arrangement

This option provides the ability to sequentially access one of two or more line side connections in the originating direction, when the access code of the line group is dialed. This feature is provided in all Telephone Company end offices. It is available with Feature Group A. FGA services with different methods of providing off-hook supervisory signaling (i.e., provided by customer's equipment vs forwarded by customer's equipment when the called party answers) cannot be mixed in the same group arrangement.

(D) Uniform Call Distribution Arrangement

This option provides a type of multiline hunting arrangement which provides for an even distribution of calls among the available lines in a hunt group. Where available, this feature is provided in Telephone Company electronic end offices only. It is available with Feature Group A.

PUBLIC SERVICE COMMISSION  
OF KENTUCKY  
EFFECTIVE

MAR 3 1992

PURSUANT TO 807 KAR 5:011,  
SECTION 9 (1)

Effective: March 3, 1992  
PUBLIC SERVICE COMMISSION MARKER

Issued: February 7, 1992

Robert E. Sigmon for President, Cincinnati, Ohio

Vice President - Regulatory Affairs

ACCESS SERVICE TARIFF  
PSCK No. 2

CINCINNATI BELL TELEPHONE COMPANY

1st Revised Page 204  
Cancels Original Page 204

6. Switched Access Service (Cont'd)

6.3 Local Switching Optional Features (Cont'd)

6.3.1 Common Switching (Cont'd)

(E) Nonhunting Number for Use with Hunt Group or Uniform Call Distribution Arrangement

This option provides an arrangement for an individual line within a multiline hunt or uniform call distribution group that provides access to that line within the hunt or uniform call distribution group when it is idle or provides busy tone when it is busy, when the nonhunting number is dialed. Where available, this feature is provided in Telephone Company electronic end offices only. It is available with Feature Group A.

(F) Automatic Number Identification (ANI) and Flexible Automatic Number Identification (Flex ANI)

This option provides the automatic transmission of a seven or ten digit number and information digits to the customer's premises for calls originating in the LATA, to identify the calling station. The ANI feature is an end office software function which is associated on a call-by-call basis with (1) all individual transmission paths in a trunk group routed directly between an end office and a customer's premises or, where technically feasible, with (2) all individual transmission paths in a trunk group between an end office and an access tandem, and a trunk group between an access tandem and a customer's premises.

PUBLIC SERVICE COMMISSION  
OF KENTUCKY  
EFFECTIVE

MAY 23 1995

PURSUANT TO 807 KAR 5011,  
SECTION 9(1)

BY: Jordan C. Neal  
FOR THE PUBLIC SERVICE COMMISSION

The seven digit ANI telephone number is available with Feature Group B. With this Feature Group, technical limitations may exist in Telephone Company switching facilities which require ANI to be provided only on a Direct-Trunked Transport basis. ANI will be transmitted (C) on all calls except those originating from coin stations and coinless pay telephones using Feature Group B, or when an ANI failure has occurred.

Issued: June 13, 1995

Effective: **May** 23, 1995

*Deborah A. Hirsch* President, Cincinnati, Ohio  
Vice President  
Integrated Corporate Planning for

6. Switched Access Service (Cont'd)6.3 Local Switching Optional Features (Cont'd)6.3.1 Common Switching (Cont'd)(F) Automatic Number Identification (ANI) and Flexible Automatic Number Identification (Flex ANI) (Cont'd)

The ten digit ANI telephone number is only available with Feature Group D with multifrequency address signaling. When the CCSAC optional feature is specified, the customer may obtain an ANI equivalent by ordering the charge number (CN) optional feature as specific in 6.3.1(K) following. The ten digit ANI telephone number consists of the Numbering Plan Area (NPA) plus the seven digit ANI telephone number. The ten digit ANI telephone number will be transmitted on all calls except those identified as ANI failure, in which case only the NPA will be transmitted (in addition to the information digits described below). Also, ANI information digits or Flexible ANI information digits will be provided to the customer along with the ten digit ANI telephone number.

- (1) The ANI Information Indicator (ANI II) digits identify: (1) telephone number is the station billing number - no special treatment required, (2) ANI failure has occurred in the end office switch which prevents identification of calling telephone number - must be obtained by operator or in some other manner, (3) hotel/motel originated call which requires room number identification, (4) coinless station, hospital inmate, etc., call which requires special screening or handling by the customer, and (5) Local Exchange Company coin. Now ANI (II) digits are either 00, 01, 02, 06, 07, 20, or 27. (C)  
(C)

Customers who subscribe to ANI may also elect to obtain expanded ANI digits, 52 for WATS, at no extra charge. (N)  
Expanded ANI digits, 52 for WATS was previously provided in this tariff under the name Flexible ANI. (N)

ACCESS SERVICE TARIFF  
PSC No. 2

CINCINNATI BELL TELEPHONE COMPANY

1st Original Page 206  
Cancels Original Page 206

6. Switched Access Service (Cont'd)

6.3 Local Switching Optional Features (Cont'd)

6.3.1 Common Switching (Cont'd)

(F) Automatic Number Identification (ANI) (Cont'd)

(2) Flexible Automatic Identification (Flex-ANI)

(C)

The Flex-ANI feature is an Optional Switching Feature and enhancement to ANI. The feature is available on inband signalling or in the Originating Line Information (IAM) Delivery Optional feature for SS7 Signalling. Flex-ANI provides additional values for the Information Indicator (ii) digits that are associated with various classes of services not available with the standard ANI digits. The customer must have ANI in order to have Flex ANI or many other features simultaneously.

The following Flex-ANI are currently available

29 confinement/detention facility  
70 private pay station

(C)

All ii codes will be delivered to the customer when Flex-ANI is ordered.

Flex ANI information digits must be ordered per Carrier Identification Code (CIC). per End Office and must be provisioned in conjunction with the ANI optional feature.

(G) (Up) to 7 Digit Outpulsing of Access Digits to Customer

**This** option provides for the end office capability of providing up to 7 digits of the uniform access code (950-OXXX or 950-1XXX) to the customer's premises. The customer can request that only some of the digits in the access code be forwarded. The access code digits would be provided to the customer's premises using multifrequency signaling, and transmission of the digits would precede the forwarding of ANI if that feature were provided. It is available with Feature Group B.

ACCESS SERVICE TARIFF  
PSC No. 2

CINCINNATI BELL TELEPHONE COMPANY

1st Revised Page 207  
Cancels Original Page 207

6. Switched Access Service (Cont'd)

6.3 Local Switching Optional Features (Cont'd)

6.3.1 Common Switching (Cont'd)

(H) Cut-Through

This option allows end users of the customer to reach the customer's premises by using the end of dialing digit. This option provides for connection of the call to the premises of the customer indicated by the 10XXX or 10XXXX (C) code upon receipt of the end of dialing digit (#). The Telephone Company will not record any other dialed digits for these calls. This option is available with Feature Group D.

(C)

(I) 900/700/976 Call Blocking

This option, where available, allows for the screening of terminating calls within the LATA for the purpose of blocking 900/976 or "dial-it" type calls only. 900/976 calls are routed to a reorder tone or to a recorded announcement. This option is available with Feature Group A. 900/976 Call Blocking, Call Denial and Service Code Denial are mutually exclusive.

(C)

(C)

900/976 Call Blocking blocks 1+900, and 976 dialed calls

(C)

ACCESS SERVICE TARIFF  
PSCK No. 2

CINCINNATI BELL TELEPHONE COMPANY

Original Page 207.1

6. Switched Access Service (Cont'd)

6.3 Local Switching Optional Features (Cont'd)

6.3.1 Common Switching (Cont'd)

(J) Calling Party Number (CPN)

This option provides for the automatic transmission of the calling party's ten digit telephone number to the customer's premises for calls originating in the LATA. The ten digit telephone number consists of the NPA plus the seven digit telephone number, which may or may not be the same number as the calling station's charge number. The specific protocol for CPN is contained in Technical Reference TR-TSV-000905. This feature is available only with Feature Group D when the CCSAC option is specified.

(K) Charge Number (CN)

This option provides for the automatic transmission of the ten digit billing number of the calling station number and originating line information. The specific protocol for CN is contained in Technical Reference TR-TSV-000905. This feature is available only with Feature Group D when CCSAC is specified.

(L) Carrier Selection Parameter (CSP)

This option provides for the automatic transmission of a signaling indicator which signifies to the customer whether the call being processed originated from a presubscribed end user of that customer. The specific protocol for CSP is contained in Technical Reference TR-TSV-000905. This feature is available only with Feature Group D when CCSAC is specified.

(N)

(N)

**PUBLIC SERVICE COMMISSION  
OF KENTUCKY  
EFFECTIVE**

OCT 26 1992

Issued: September 24, 1992

PURSUANT TO 807 KAR 5.011,  
Effective: October 26, 1992  
SECTION 9 (1)

*Robert E. Hyman*

President, Cincinnati, Ohio

BY: *Sharon Hallee*  
PUBLIC SERVICE COMMISSION MANAGER

Vice President - Regulatory Affairs



6. Switched Access Service (Cont'd)

6.3 Local Switching Optional Features (Cont'd)

6.3.1 Common Switching (Cont'd)

(M) Service Class Routing

This option provides the capability of directing originating traffic from an end office to a trunk group to a customer designated premises, based on the line class of service (e.g., coin or hotel/motel), service prefix indicator (e.g., 0-, 0+, 01+ or 011+) or service access code (e.g., 500, 800 or 900). (C)  
It is provided in suitably equipped end office or access switches and is available with Feature Group D.

(N) Alternate Traffic Routing

(1) Multiple Customer Premises Alternate Routing

This option provides the capability of directing originating traffic from an end office (or appropriately equipped access tandem) to a trunk group (the "high usage" group) to a customer designated premises until that group is fully loaded, and then delivering additional originating traffic (the "overflowing" traffic) from the same end office or access tandem to a different trunk group (the "final" group) to a second customer designated premises. It is provided in suitably equipped end office or access tandem switches and is available with Feature Groups B and D.

(2) End Office Alternate Routing

This option provides an alternate routing arrangement for customers who have access for a particular Feature Group to an end office via two routes: one route via an access tandem and one direct route. The feature allows the customers originating traffic from the end office to be offered first to the direct trunk group and then overflow to the access tandem group. It is provided in suitably equipped end offices and is available with Feature Groups B and D.

6. Switched Access Service (Cont'd)

6.3 Local Switching Optional Features (Cont'd)

6.3.1 Common Switching (Cont'd)

(0) International Carrier Option

This option allows for Feature Group D end offices or access tandem switches equipped for International Direct Distance Dialing to be arranged to forward the international calls of one or more international carriers to the customer (i.e., the Telephone Company is able to route originating international calls to a customer other than the one designated by the end user either through presubscription or 10XXX or 101-XXXX dialing). (C)  
This arrangement requires provision of written verification to the Telephone Company that the customer is authorized to forward such calls. The written verification must be in the form of a letter of agency authorizing the customer to order the option on behalf of the international carrier. This option is only provided at Telephone Company end offices or access tandems equipped for International Direct Distance Dialing. It is available with Feature Group D.

ACCESS SERVICE TARIFF  
PSCK No. 2

CINCINNATI BELL TELEPHONE COMPANY

1st Revised Page 210  
Cancels Original Page 210

6. Switched Access Service (Cont'd)

6.3 Local Switching Optional Features (Cont'd)

6.3.1 Common Switching (Cont'd)

(P) Band Advance Arrangement for Use with WATS Access Line Service (T)

This option, which is provided in association with two or more WATS Access Line Service groups, provides for the automatic overflow of terminating calls to a WATS Access Line Service group, when that group has exceeded its call capacity, to another WATS Access Line Service group with a band designation equal to or greater than that of the overflowing WATS Access Line Service group. This arrangement does not provide for call overflow from a group with a higher band designation to one with a lower one. This option is available with Features Groups A, B and D.

(Q) End Office End User Line Service Screening for Use with WATS Access Line Service (T)

This option provides the ability to verify that an end user has dialed a called party address (by screening the called NPA and/or NXX on the basis of geographical bands selected by the Telephone Company) which is in accordance with that end user's service agreement with the customer, e.g., WATS. This option is provided in all Telephone Company electronic end offices and, where available, in electromechanical end offices in which WATS or Special Access Line Service is provided. It is available with Feature Group D.

(R) Hunt Group Arrangement for Use with WATS Access Line Service (T)

This option provides the ability to sequentially access one of two or more WATS Access Line Services (e.g., 800 Service access lines) in the terminating direction, when the hunting number of the WATS Access Line Service group is forwarded from the customer to the Telephone Company. This feature is provided in all Telephone Company end offices in which WATS Access Line Service is provided. It is available with Feature Groups A, B and D.

**PUBLIC SERVICE COMMISSION  
OF KENTUCKY  
EFFECTIVE**

OCT 26 1992

PURSUANT TO 807 KAR 5:011.

Issued: September 24, 1992

Effective: October 28, 1992

Robert E. & — for

President, Cincinnati, Ohio

BY:   
PUBLIC SERVICE COMMISSION MANAGER

Vice President - Regulatory Affairs

ACCESS SERVICE TARIFF  
PSCK No. 2

CINCINNATI BELL TELEPHONE COMPANY

Original Page 211

6. Switched Access Service (Cont'd)

6.3 Local Switching Optional Features (Cont'd)

6.3.1 Common Switching (Cont'd)

(P) Uniform Call Distribution Arrangement for Use with WATS Access Line Service

This option provides a type of multiline hunting arrangement which provides for an even distribution of terminating calls among the available WATS Access Line Services in the hunt group. Where available, this feature is only provided in Telephone Company electronic end offices in which WATS Access Line Service is provided. It is available with Feature Groups A, B and D.

(Q) Nonhunting Number for Use with Hunt Group Arrangement or Uniform Call Distribution Arrangement for Use with WATS Access Line Service

This option provides an arrangement for an individual WATS Access Line Service within a multiline hunt or uniform call distribution group that provides access to that WATS Access Line Service within the hunt or uniform call distribution group when it is idle or provides busy tone when it is busy, when the nonhunting number is dialed. Where available, this feature is only provided in Telephone Company electronic end offices in which WATS Access Line Service is provided. It is available with Feature Groups A, B and D.

(R) Feature Group D with 950 Access

This option provides for the routing of originating calls dialed using a customer's 950-~~XXXX~~ access code to the customer over Feature Group D trunks, using Feature Group D signaling protocols and technical specifications. The customer's switch must be prepared to differentiate between standard Feature Group D calls and 950-dialed calls delivered over the same trunk group, and must also differentiate between Non-Public Stations and Coin or Hotel/Motel Stations. Where technically feasible, this feature is available with Feature Group D.

PUBLIC SERVICE COMMISSION  
OF KENTUCKY  
EFFECTIVE

MAR 3 1992

Issued: February 7, 1992

PURSUANT TO 907 KAR 5-0192  
Effective: March 3, 1992

SECTION 9 (1)

*Robert E. Aigmon* for President, Cincinnati, Ohio

BY: *Sharon Hella*  
PUBLIC SERVICE COMMISSION MANAGER

Vice President - Regulatory Affairs

ACCESS SERVICE TARIFF  
PSCK No. 2

CINCINNATI BELL TELEPHONE COMPANY

1st Revised Page 212  
Cancels Original Page 212

6. Switched Access Service (Cont'd)

6.3 Local Switchinn Optional Features (Cont'd)

6.3.2 Transport Termination

(A) Rotary Dial Station Signaling

This option provides for the transmission of called party address signaling from rotary dial stations to the customer's premises for originating calls. This option is provided in the form of a specific type of Transport Termination. It is available with Feature Group B, only on a ~~Direct-Trunked~~ Transport basis.

(C)

PUBLIC SERVICE COMMISSION  
OF KENTUCKY  
EFFECTIVE

MAY 23 1995

PURSUANT TO 807 KAR 5011,  
SECTION 9(1)

BY: Jordan C. Neal  
FOR THE PUBLIC SERVICE COMMISSION

Issued: June 13, 1995

Effective: May 23, 1995

*Deborah A. Nisch* President, Cincinnati, Ohio  
Vice President  
Integrated Corporate Planning for

ACCESS SERVICE TARIFF  
PSCK No. 2

CINCINNATI BELL TELEPHONE COMPANY

2nd Revised Page 213  
Cancels 1st Revised Page 213

6. Switched Access Service (Cont'd)

6.3 Local Switching Optional Features (Cont'd)

6.3.2 Transport Termination (Cont'd)

(B) Operator Trunk - Full Feature

This option provides the operator functions available in the end office to the customer's operator. These functions are (1) Operator Released, (2) Operator Attached, (3) Coin Collect, (4) Coin Return, and (5) Ring-back. It is available with Feature Group D and is provided as a trunk type for Switched Transport Termination. This option is not available in combination with the CCSAC option. (C)

6.3.3 WATS Access Line Termination

The WATS Access Line or Voice Grade Special Access Service Terminations are differentiated by line side vs. trunk side terminations. The standard WATS Access Line or Voice Grade Special Access arrangement is available with a line side termination. There are various types of originating and terminating line side terminations depending on the type of signaling associated with the WATS Access Line or Voice Grade Special Access Service (i.e., loop start or ground start). Line side terminations are available with either dial pulse or dual tone multifrequency address signaling.

PUBLIC SERVICE COMMISSION  
OF KENTUCKY  
EFFECTIVE

MAY 23 1995

PURSUANT TO 807 KAR 5:011,  
SECTION 9 (1)  
BY: Jordan C. Neal  
FOR THE PUBLIC SERVICE COMMISSION

Issued: **June 13, 1995**

Effective: **May 23, 1995**

 Deborah A. Nisch, President, Cincinnati, Ohio  
Vice President  
Integrated Corporate Planning for

ACCESS SERVICE TARIFF  
PSC No. 2

CINCINNATI BELL TELEPHONE COMPANY

1st Revised Page 214  
Cancels Original Page 214

6. Switched Access Service (Cont'd)

6.4 Transmission Specifications

Each Switched Access Service transmission path is provided with standard transmission specifications. There are three different standard specifications (Types A, B and Q). The standard for a particular transmission path is dependent on the Feature Group, the Interface Group and whether the service is directly routed or via an access tandem. The available transmission specifications are set forth in 6.4.1 following. Data Transmission Parameters are also provided with each Switched Access Service transmission path. The Telephone Company will, upon notification by the customer that the data parameters set forth in 6.4.2(A) or 6.4.2(B) are not being met, conduct tests independently or in cooperation with the customer, and take any necessary action to insure that the data parameters are met.

The Telephone Company will maintain existing transmission specifications on functioning service configurations installed prior to the effective date of this tariff except that service configurations having performance specifications exceeding the standards listed in this provision will be maintained at performance levels specified in this tariff.

The transmission specifications contained in this Section are immediate action limits. Acceptance limits are set forth in Technical Reference TR-NPL-000334. This Technical Reference also provides the basis for determining Switched Access Service maintenance limits. Transmission specifications for CCSAC signaling connections are set forth in Technical Reference TR-TSV-000905.

(C)  
|  
(C)

PUBLIC SERVICE COMMISSION  
OF KENTUCKY  
EFFECTIVE

OCT 26 1992

PURSUANT TO 807 KAR 5:011.  
SECTION 9 (1)

BY: Sharon Helle  
PUBLIC SERVICE COMMISSION MANAGER

Issued: September 24, 1992

Effective: October 26, 1992

Robert E. Sigmon for President, Cincinnati, Ohio

Vice President - Regulatory Affairs

6. Switched Access Service (Cont'd)

6.4 Transmission Specifications (Cont'd)

6.4.1 Standard Transmission Specifications

Following are descriptions of the three Standard Transmission Specifications available with Switched Access Service Feature Groups. The specific applications in terms of the Feature Groups and Interface Groups with which the Feature Group Standard Transmission Specifications are provided are set forth in 6.2.1(C), 6.2.2(C) and 6.2.4(C) preceding.

(A) Type A Transmission—Specifications

Type A Transmission Specifications is provided with the following parameters:

(1) Loss Deviation

The maximum Loss Deviation of the 1004 Hz loss relative to the Expected Measured Loss (EML) is  $\pm 2.0$  dB

PUBLIC SERVICE COMMISSION  
OF KENTUCKY  
EFFECTIVE

MAR 3 1992

PURSUANT TO 807 KAR 5:011,  
SECTION 9 (1)

Effective: March 3, 1992  
BY: [Signature]  
PUBLIC SERVICE COMMISSION MANAGER

Issued: February 7, 1992

Robert E. Sigman for  
President, Cincinnati, Ohio

Vice President - Regulatory Affairs



ACCESS SERVICE TARIFF  
PSCK No. 2

CINCINNATI BELL TELEPHONE COMPANY

Original Page 216

6. Switched Access Service (Cont'd)

6.4 Transmission Specifications (Cont'd)

6.4.1 Standard Transmission Specifications (Cont'd)

(A) Type A Transmission Specifications (Cont'd)

(2) Attenuation Distortion

The maximum Attenuation Distortion in the 404 to 2804 Hz frequency band relative to the loss at 1004 Hz is -1.0 dB to +3.0 dB.

(3) C-Message Noise

The maximum C-Message Noise for the transmission path at the route miles listed is less than or equal to:

| <u>Route Miles</u> | <u>C-Message Noise</u> |
|--------------------|------------------------|
| less than 50       | 32 dBrnC0              |
| 51 to 100          | 34 dBrnC0              |
| 101 to 200         | 37 dBrnC0              |
| 201 to 400         | 40 dBrnC0              |
| 401 to 1000        | 42 dBrnC0              |

(4) C-Notch Noise

The maximum C-Notch Noise, utilizing a -16 dBm0 holding tone, is less than or equal to 45 dBrnC0.

(5) Echo Control

Echo Control, identified as Equal Level Echo Path Loss, and expressed as Echo Return Loss and Singing Return Loss, is dependent on the routing, i.e., whether the service is routed directly from the customer's point of termination (POT) to the end office or via an access tandem. It is equal to or greater than the following:

PUBLIC SERVICE COMMISSION  
OF KENTUCKY  
EFFECTIVE

MAR 3 1992

Issued: February 7, 1992

*Robert L. Johnson* for

President, Cincinnati, Ohio

PURSUANT TO 807 KAR 5:011,

SECTION 9 (1)

Effective: March 3, 1992

BY: *Glenn D. Helle*  
PUBLIC SERVICE COMMISSION MANAGER

Vice President - Regulatory Affairs

ACCESS SERVICE TARIFF  
PSCK No. 2

CINCINNATI BELL TELEPHONE COMPANY

Original Page 217

6. Switched Access Service (Cont'd)

6.4 Transmission Specifications (Cont'd)

6.4.1 Standard Transmission Specifications (Cont'd)

(A) Type A Transmission Specifications (Cont'd)

(5) Echo Control (Cont'd)

|                      | <u>Echo Return Loss</u> | <u>Singing Return Loss</u> |
|----------------------|-------------------------|----------------------------|
| POT to Access Tandem | 21 dB                   | 14 dB                      |
| POT to End Office    |                         |                            |
| - Direct             | N/A                     | N/A                        |
| - Via Access Tandem  | 16 dB                   | 11 dB                      |

(B) Type B Transmission Specifications

Type B Transmission Specifications is provided with the following parameters:

(1) Loss Deviation

The maximum Loss Deviation of the 1004 Hz loss relative to the Expected Measured Loss (EML) is + 2.5 dB.

(2) Attenuation Distortion

The maximum Attenuation Distortion in the 404 to 2804 Hz frequency band relative to loss at 1004 Hz is 2.0 dB to +4.0 dB.

PUBLIC SERVICE COMMISSION  
OF KENTUCKY  
EFFECTIVE

MAR 3 1992

PURSUANT TO 807 KAR 5:011,

SECTION 9 (1)

Effective March 3, 1992

BY: *[Signature]*  
PUBLIC SERVICE COMMISSION MANAGER

Issued: February 7, 1992

*Robert E. Aigunon*

for

President, Cincinnati, Ohio

**Vice President - Regulatory Affairs**

ACCESS SERVICE TARIFF  
PSCK No. 2

CINCINNATI BELL TELEPHONE COMPANY

Original Page 218

6. Switched Access Service (Cont'd)

6.4 Transmission Specifications (Cont'd)

6.4.1 Standard Transmission Specifications (Cont'd)

(B) Type B Transmission Specifications (Cont'd)

(3) C-Message Noise

The maximum C-Message Noise for the transmission path at the route miles listed is less than or equal to:

| <u>Route Miles</u> | <u>C-Message Noise*</u> |                |
|--------------------|-------------------------|----------------|
|                    | <u>Type B1</u>          | <u>Type B2</u> |
| less than 50       | 32 dBrnC0               | 35 dBrnC0      |
| 51 to 100          | 33 dBrnC0               | 37 dBrnC0      |
| 101 to 200         | 35 dBrnC0               | 40 dBrnC0      |
| 201 to 400         | 37 dBrnC0               | 43 dBrnC0      |
| 401 to 1000        | 39 dBrnC0               | 45 dBrnC0      |

(4) C-Notch Noise

The maximum C-Notch Noise, utilizing a -16 dBm0 holding tone is less than or equal to 47 dBrnC0.

(5) Echo Control

Echo Control, identified as Impedance Balance for FGA and FGB and Equal Level Echo Path Loss for FGD, and expressed as Echo Return Loss (ERL) and Singing Return Loss (SRL), is dependent on the routing, i.e., whether the service is routed directly from the customer's point of termination (POT) to the end office or via an access tandem. The ERL and SRL also differ by Feature Group, type of termination, and type of transmission path. They are greater than or equal to the following:

**PUBLIC SERVICE COMMISSION  
OF KENTUCKY  
EFFECTIVE**

MAR 3 1992

\* For Feature Group D only Type B2 will be provided. For Feature Groups A and B, Type B1 and B2 will be provided as set forth in Technical Reference CAR 5:011, TR-NPL-000334. SECTION 9 (1)

BY: *[Signature]*  
Effective Date: March 3, 1992  
PUBLIC SERVICE COMMISSION MANAGER

Issued: February 7, 1992

*[Signature]*

for

President, Cincinnati, Ohio

**Vice President - Regulatory Affairs**

ACCESS SERVICE TARIFF  
PSCK No. 2

CINCINNATI BELL TELEPHONE COMPANY

Original Page 219

6. Switched Access Service (Cont'd)

6.4 Transmission Specifications (Cont'd)

6.4.1 Standard Transmission Specifications (Cont'd)

(B) Type B Transmission Specifications (Cont'd)

(5) Echo Control (Cont'd)

|   | <u>Echo Return Loss</u> | <u>Singing Return Loss</u> |
|---|-------------------------|----------------------------|
| POT to Access Tandem                    |                         |                            |
| - Terminated in<br>4-Wire trunk         | 21 dB                   | 14 dB                      |
| - Terminated in<br>2-Wire trunk         | 16 dB                   | 11 dB                      |
| POT to End Office                       |                         |                            |
| - Direct                                | 16 dB                   | 11 dB                      |
| - Via Access Tandem<br>. For FGB access | 8 dB                    | 4 dB                       |

**PUBLIC SERVICE COMMISSION  
OF KENTUCKY  
EFFECTIVE**

MAR 3 1992

**PURSUANT TO 807 KAR 5:011,  
SECTION 9(1)**

Issued: February 7, 1992

Effective: *March 3, 1992*  
PUBLIC SERVICE COMMISSION MANAGER

*Robert H. Brown*  
President, Cincinnati, Ohio

*Robert H. Brown*  
Vice President - Regulatory Affairs

ACCESS SERVICE TARIFF  
PSC No. 2

CINCINNATI BELL TELEPHONE COMPANY

Original Page 220

6. Switched Access Service (Cont'd)

6.4 Transmission Specifications (Cont'd)

6.4.1 Standard Transmission Specifications (Cont'd)

(C) Type C Transmission Specifications

Type C Transmission Specifications is provided with the following parameters:

(1) Loss Deviation

The maximum Loss Deviation of the 1004 Hz loss relative to the Expected Measured Loss (EML) is  $\pm 3.0$  dB.

(2) Attenuation Distortion

The maximum Attenuation Distortion in the 404 to 2804 Hz frequency band relative to loss at 1004 Hz is  $-2.0$  dB to  $+5.5$  dB.

(3) C-Message Noise

The maximum C-Message Noise for the transmission path at the route miles listed is less than or equal to:

| <u>Route Miles</u> | <u>C-Message Noise*</u> |                |
|--------------------|-------------------------|----------------|
|                    | <u>Type C1</u>          | <u>Type C2</u> |
| less than 50       | 32 dBrnC0               | 38 dBrnC0      |
| 51 to 100          | 33 dBrnC0               | 39 dBrnC0      |
| 101 to 200         | 35 dBrnC0               | 41 dBrnC0      |
| 201 to 400         | 37 dBrnC0               | 43 dBrnC0      |
| 401 to 1000        | 39 dBrnC0               | 45 dBrnC0      |

(4) C-Notch Noise

The maximum C-Notch Noise, utilizing a  $-16$  dBm0 holding tone is less than or equal to 47 dBrnC0.

\* For Feature Group D only Type C2 will be provided. For A and B, Type C1 or C2 will be provided as set forth in TR-NPL-000-334.

PUBLIC SERVICE COMMISSION  
Feature of Kentucky  
Technical Reference  
EFFECTIVE

MAR 3 1992

Issued: February 7, 1992

PURSUANT TO 807 KAR 5-0-1  
SECTION 3, 1992  
Effective March 3, 1992

*Robert E. Seymour*

FOR

President, Cincinnati, Ohio

BY: *Chauvelles*  
PUBLIC SERVICE COMMISSION MANAGER

Vice President - Regulatory Affairs

ACCESS SERVICE TARIFF  
PSCK No. 2

CINCINNATI BELL TELEPHONE COMPANY

Original Page 221

6. Switched Access Service (Cont'd)

6.4 Transmission Specifications (Cont'd)

6.4.1 Standard Transmission Specifications (Cont'd)

(C) Type C Transmission Specifications (Cont'd)

(5) Echo Control

Echo Control, identified as Return Loss and expressed as Echo Return Loss and Singing Return Loss is equal to or greater than the following:

|                               | <u>Echo Return Loss</u> | <u>Singing Return Loss</u> |
|-------------------------------|-------------------------|----------------------------|
| POT to End Office<br>- Direct | 13 dB                   | 6 dB                       |

PUBLIC SERVICE COMMISSION  
OF KENTUCKY  
EFFECTIVE

MAR 3 1992

PURSUANT TO 807 KAR 5:011,  
SECTION 9 (1)

BY: *Glenn Miller*

Effective: ~~March 3, 1992~~ <sup>1992</sup> CER

Issued: February 7, 1992

*Robert E. Aigmon* for President, Cincinnati, Ohio

Vice President - Regulatory Affairs

ACCESS SERVICE TARIFF  
PSC No. 2

CINCINNATI BELL TELEPHONE COMPANY

Original Page 222

6. Switched Access Service (Cont'd)

6.4 Transmission Specifications (Cont'd)

6.4.2 Data Transmission Parameters

Two types of Data Transmission Parameters, i.e., Type DA and Type DB, are provided for the Feature Group arrangements. The specific applications in terms of the Feature Groups with which they are provided are set forth in 6.2.1(C), 6.2.2(C) and 6.2.4(C) preceding. Following are descriptions of each.

(A) Data Transmission Parameters Type DA

(1) Signal to C-Notched Noise Ratio

The Signal to C-Notched Noise Ratio is equal to or greater than **33** dB.

PUBLIC SERVICE COMMISSION  
OF KENTUCKY  
EFFECTIVE

MAR 3 1992

PURSUANT TO 807 KAH 5:011

SECTION 9 (1)

Effective: March 3, 1992  
PUBLIC SERVICE COMMISSION MANAGER

Issued: February 7, 1992

Robert E. Sigmon for President, Cincinnati, Ohio

Vice President - Regulatory Affairs

ACCESS SERVICE TARIFF  
PSC No. 2

CINCINNATI BELL TELEPHONE COMPANY

Original Page 223

6. Switched Access Service (Cont'd)

6.4 Transmission Specifications (Cont'd)

6.4.2 Data Transmission Parameters (Cont'd)

(A) Data Transmission Parameters True DA (Cont'd)

(2) Envelope Delay Distortion

The maximum Envelope Delay Distortion for the frequency bands and route miles specified is:

604 to 2804 Hz

|   |                  |
|---|------------------|
| less than 50 route miles                | 500 microseconds |
| equal to or greater than 50 route miles | 900 microseconds |

1004 to 2404 Hz

|   |                  |
|---|------------------|
| less than 50 route miles                | 200 microseconds |
| equal to or greater than 50 route miles | 400 microseconds |

(3) Impulse Noise Counts

The Impulse Noise Counts exceeding a 65 dBmCO threshold in 15 minutes is no more than 15 counts.

(4) Intermodulation Distortion

The Second Order (R2) and Third Order (R3) Intermodulation Distortion products are equal to or greater than:

|                   |       |
|-------------------|-------|
| Second Order (R2) | 33 dB |
| Third Order (R3)  | 37 dB |

(5) Phase Jitter

The Phase Jitter over the 4-300 Hz frequency band is less than or equal to 5' peak-to-peak.

(6) Frequency Shift

The maximum Frequency Shift does not exceed ~~200 Hz~~ **PUBLIC SERVICE COMMISSION**  
**OF KENTUCKY**  
**EFFECTIVE**

MAR 3 1992

Issued: February 7, 1992

Effective: ~~March 3, 1992~~ **PURSUANT TO KRS 192.011,**  
**SECTION 9 (1)**

*Robert E. Aigmon* for President, Cincinnati, Ohio

BY: *Clayton Deller*  
PUBLIC SERVICE COMMISSION MANAGER

Vice President - Regulatory Affairs



ACCESS SERVICE TARIFF  
PSCK No. 2

CINCINNATI BELL TELEPHONE COMPANY

Original Page 224

6. Switched Access Service (Cont'd)

6.4 Transmission Specifications (Cont'd)

6.4.2 Data Transmission Parameters (Cont'd)

(B) Data Transmission Parameters ~~Tvve~~ DB

(1) Signal to C-Notched Noise Ratio

The signal to C-Notched Noise Ratio is equal to or greater than 30 dB.

(2) Envelope Delay Distortion

The maximum Envelope Delay Distortion for the frequency bands and route miles specified is:

|   | <u>604 to 2804 Hz</u>  |                   |
|---|------------------------|-------------------|
| less than 50 route miles                |                        | 800 microseconds  |
| equal to or greater than 50 route miles |                        | 1000 microseconds |
|   | <u>1004 to 2404 Hz</u> |                   |
| less than 50 route miles                |                        | 320 microseconds  |
| equal to or greater than 50 route miles |                        | 500 microseconds  |

(3) Impulse Noise Counts

The Impulse Noise Counts exceeding a 67 dBm00 threshold in 15 minutes is no more than 15 counts.

(4) Intermodulation Distortion

The Second Order (R2) and Third Order (R3) Intermodulation Distortion products are equal to or greater than:

|                   |       |
|-------------------|-------|
| Second Order (R2) | 31 dB |
| Third Order (R3)  | 34 dB |

(5) Phase Jitter

The Phase Jitter over the 4-300 Hz frequency band is less than or equal to 7' peak-to-peak.

**PUBLIC SERVICE COMMISSION**  
of the State of Ohio  
EFFECTIVE

(6) Frequency Shift

The maximum Frequency Shift does not exceed -2 to +2 Hz.

PURSUANT TO 807 KAR 5.011,  
SECTION 9 (1)

MAR 3 1992

Issued: February 7, 1992

Effective: March 3, 1992

PUBLIC SERVICE COMMISSION MANAGER

*Robert E. Aigmon* for  
President, Cincinnati, Ohio

Vice President - Regulatory Affairs

ACCESS SERVICE TARIFF  
PSCK No. 2

CINCINNATI BELL TELEPHONE COMPANY

Original Page 225

6. Switched Access Service (Cont'd)

6.5 Obligations of the Telephone Company

In addition to the obligations of the Telephone Company set forth in 2. preceding, the Telephone Company has certain other obligations pertaining only to the provision of Switched Access Service. These obligations are as follows:

6.5.1 Network Management

The Telephone Company will administer its network to insure the provision of acceptable service levels to all telecommunications users of the Telephone Company's network services. Generally, service levels are considered acceptable only when both end users and customers are able to establish connections with little or no delay encountered within the Telephone Company network. The Telephone Company maintains the right to apply protective controls, i.e., those actions, such as call gapping, which selectively cancel the completion of traffic, over any traffic carried over its network, including that associated with a customer's Switched Access Service. Generally, such protective measures would **only** be taken as a result of occurrences such as failure or overload of Telephone Company or customer facilities, natural disasters, mass calling or national security demands. The customer will notify the Telephone Company of anticipated peaked services per paragraph 6.6.1(E). Based on the information provided, the Telephone Company will work cooperatively with the customer to determine the appropriate level of control. In the event that the protective controls applied by the Telephone Company result in the complete loss of service by the customer, the customer will be granted a Credit Allowance for Service Interruption as set forth in 2.4.4(B)(3) preceding except where voided by paragraph 6.6.1(E) following.

PUBLIC SERVICE COMMISSION  
OF KENTUCKY  
EFFECTIVE

MAR 3 1992

PURSUANT TO 807 KAR 5:011,

SECTION 9(1)  
Effective: March 3, 1992  
BY: Gregg D. Bell  
PUBLIC SERVICE COMMISSION MANAGER

Issued: February 7, 1992

Robert E. Sigmon for President, Cincinnati, Ohio

Vice President - Regulatory Affairs

ACCESS SERVICE TARIFF  
PSCK No. 2

CINCINNATI BELL TELEPHONE COMPANY

1st Revised Page 226  
Cancels Original Page 226

6. Switched Access Service (Cont'd)

6.5 Oblinations of the Telephone Company (Cont'd)

6.5.2 Design and Traffic Routing of Switched Access Service

For Switched Access Service, ordered on a per line or per trunk basis. the customer desired line or trunk directionality and/or traffic routing of the Switched Access Service between the customer's premises and the entry switch are specified on the customer's order for service. Also, the customer must specify on the Switched Transport facilities to be used (i.e., Entrance Facility, Direct-Trunked Transport facility, and Tandem-Switched Transport facility). When specifying the Switched Transport facilities to be used, the customer must indicate if the facilities are existing or new.

Except for Feature Group B the Telephone Company will be responsible for selection of facilities from the interface to any switching point and to the end offices where capacity is ordered. For Feature Group B the customer may order the optional feature Customer Specification of Switched Transport Termination.

(C)

(C)

PUBLIC SERVICE COMMISSION  
OF KENTUCKY  
EFFECTIVE

MAY 23 1995

PURSUANT TO 807 KAR 5.011,  
SECTION 9(1)

BY: Jordan C. Neel  
FOR THE PUBLIC SERVICE COMMISSION

Issued: June 13, 1995

Effective: May 23, 1995

Deborah A. Nisch President, Cincinnati, Ohio

Vice President

Integrated Corporate Planning for

ACCESS SERVICE TARIFF  
PSCK No. 2

CINCINNATI BELL TELEPHONE COMPANY

2nd Revised Page 227  
Cancels 1st Revised Page 227

6. Switched Access Service (Cont'd)

6.5 Obligations of the Telephone Company (Cont'd)

6.5.2 Design and Traffic Routing of Switched Access Service

PUBLIC SERVICE COMMISSION  
OF KENTUCKY  
EFFECTIVE

MAY 23 1995

PURSUANT TO 807 KAR 5:011,  
SECTION 9(1)

BY: Jordan C.  
FOR THE PUBLIC SERVICE COMMISSION

(D)

(D)

6.5.3 Provision of Service Performance Data

Subject to availability, end-to-end service performance data available to the Telephone Company through its own service evaluation routines, may also be made available to the customer based on previously arranged intervals and format. These data provide information on overall end-to-end call completion and noncompletion performance, e.g., customer equipment blockage, failure results and transmission performance. These data do not include service performance data which are provided under other tariff sections, e.g., testing service results. If data are to be provided in other than paper format, the charges for such exchange will be determined on an individual case basis.

6.5.4 Trunk Group Measurement Reports

Subject to availability, the Telephone Company will make available trunk group data in the form of usage in hundred calls seconds, peg count and overflow, to the customer based on previously agreed to intervals.

Issued: June 13, 1995

Effective: May 23, 1995

*Deborah A. Hesch*

President, Cincinnati, Ohio

Vice President  
Integrated Corporate Planning for

ACCESS SERVICE TARIFF  
PSCK No. 2

CINCINNATI BELL TELEPHONE COMPANY

2nd Revised Page 228  
Cancels 1st Revised Page 228

6. Switched Access Service (Cont'd)

6.5 Obligations of the Telephone Company (Cont'd)

6.5.5 Determination of Number of Transmission Paths

PUBLIC SERVICE COMMISSION  
OF KENTUCKY  
EFFECTIVE

MAY 23 1995

PURSUANT TO 807 KAR 5.011,  
SECTION 9(1)

BY: Jordan C. Neel  
FOR THE PUBLIC SERVICE COMMISSION

(D)

6.5.6 Determination of Number of End Office Transport Terminations

For analog entry switches, a termination will be provided for each feature group line or trunk requested. For digital entry switches, an equivalent termination will be provided for each feature group line or trunk requested.

(C)

(C)

Issued: June 13, 1995

Effective: May 23, 1995

Deborah A. Nisch President, Cincinnati, Ohio  
Vice President  
Integrated Corporate Planning for

ACCESS SERVICE TARIFF  
PSCK No. 2

CINCINNATI BELL TELEPHONE COMPANY

2nd Revised Page 229  
Cancels 1st Revised Page 229

6. Switched Access Service (Cont'd)

6.5 Oblinations of the Telephone Company (Cont'd)

6.5.7 Design Blocking Probability

The Telephone Company will design and monitor the facilities used in the provision of Switched Access Service to meet the blocking probability criteria as set forth in (A) through (D) following.

- (A) For Feature Groups A and B no design blocking criteria apply.
- (B) For Feature Group D, the design blocking objective for the final group will be no greater than one percent (.01) between the point of termination at the customer's premises and the end office switch, whether the traffic is directly routed without an alternate route or routed via an access tandem. Standard traffic engineering methods as set forth in reference document Special Report SR-TAP-000191 Issue No. 2, Trunk Traffic Engineering Concepts and Applications will be used by the Telephone Company to determine the number of transmission paths required to achieve this level of blocking. (C)
- (C) For 900 Access Service, the design blocking criteria is dependent on the status of the end office from which the service is provided. The design blocking criteria for 900 Access Service provided from an end office not equipped with equal access capabilities will be equivalent to that set forth preceding for Feature Group C. The design blocking criteria for 900 Access Service provided from an end office equipped with equal access capabilities will be equivalent to that set forth preceding for Feature Group D.

PUBLIC SERVICE COMMISSION  
OF KENTUCKY  
EFFECTIVE

MAY 23 1995

PURSUANT TO 807 KAR 5.011,  
SECTION 9(1)

FOR THE PUBLIC SERVICE COMMISSION

Issued: June 13, 1995

Effective: May 23, 1995

  
Deborah A. Risch, President, Cincinnati, Ohio  
Vice President  
Integrated Corporate Planning for

ACCESS SERVICE TARIFF  
PSC No. 2

CINCINNATI BELL TELEPHONE COMPANY

1st Revised Page 230  
Cancels *Original* Page 230

6. Switched Access Service (Cont'd)

6.5 Obligations of the Telephone Company (Cont'd)

6.5.7 Design Blocking Probability (Cont'd)

- (D) The Telephone Company will perform routine measurement functions for the capacity ordered to assure that an adequate number of transmission paths are in service. The Telephone Company will recommend that additional capacity be ordered by the customer when additional paths are required to reduce the measured blocking level. Where design blocking criteria apply, the design blocking objective is assumed to have been met if the routine measurements show that the measured blocking does not exceed the thresholds listed in the following tables.

(C)  
|  
(C)

PUBLIC SERVICE COMMISSION  
OF KENTUCKY  
EFFECTIVE

MAY 23 1995

PURSUANT TO 807 KAR 5:011,  
SECTION 9(1)  
BY: Jordan C. Neel  
FOR THE PUBLIC SERVICE COMMISSION

Issued: June 13, 1995

Effective: **May 23, 1995**

 **Deborah Risch**, President, Cincinnati, Ohio  
Vice President  
Integrated Corporate Planning for

ACCESS SERVICE TARIFF  
PSCK No. 2

CINCINNATI BELL TELEPHONE COMPANY

Original Page 231

6. Switched Access Service (Cont'd)

6.5 Obligations of the Telephone Company (Cont'd)

6.5.7 Design Blocking Probability (Cont'd)

(D) (Cont'd)

- (1) For transmission paths carrying only first routed traffic directly between an end office and customer's premises without an alternate route, and for paths carrying only overflow traffic, the measured blocking thresholds are as follows:

| Number of<br>Transmission Paths<br>Per Trunk Group | Measured Blocking Thresholds<br>in the Time Consistent Busy Hour<br>for the Number of Measurements |                       |                      |                     |
|--|--|-----------------------|----------------------|---------------------|
|  | Per Trunk Group  |                       |                      |                     |
|  | 15-20<br>Measurements  | 11-14<br>Measurements | 7-10<br>Measurements | 3-6<br>Measurements |
| 2  | .070   | .080                  | .090                 | .140                |
| 3  | .050   | .060                  | .070                 | .090                |
| 4  | .050   | .060                  | .070                 | .080                |
| 5-6  | .040   | .050                  | <b>.060</b>          | <b>.070</b>         |
| 7 or more  | .030   | .035                  | .040                 | .060                |

- (2) For transmission paths carrying first routed traffic between an end office and customer's premises via an access tandem, the measured blocking thresholds are as follows:

| Number of<br>Transmission Paths<br>Per Trunk Group | Measured Blocking Thresholds<br>in the Time Consistent Busy Hour<br>for the Number of Measurements |                       |                      |                     |
|--|--|-----------------------|----------------------|---------------------|
|  | Per Trunk Group  |                       |                      |                     |
|  | 15-20<br>Measurements  | 11-14<br>Measurements | 7-10<br>Measurements | 3-6<br>Measurements |
| 2  | .045   | .055                  | .060                 | .095                |
| 3  | .035   | .040                  | .045                 | .060                |
| 4  | .035   | .040                  | <b>.045</b>          | <b>.060</b>         |
| 5-6  | <b>.025</b>  | .035                  | .040                 | <b>.060</b>         |
| 7 or more  | <b>.020</b>  | .025                  | .030                 | <b>.060</b>         |

PUBLIC SERVICE COMMISSION  
OF KENTUCKY  
EFFECTIVE

MAR 3 1992

PURSUANT TO 807 KAR 5:011,

SECTION 9 (1)

Effective: March 3, 1992

BY: Gregory Balle  
PUBLIC SERVICE COMMISSION MANAGER

Issued: February 7, 1992

Robert E. Aigmon for President, Cincinnati, Ohio

Vice President - Regulatory Affairs



ACCESS SERVICE TARIFF  
PSCK No. 2

CINCINNATI BELL TELEPHONE COMPANY

1st Revised Page 232  
Cancels Original Page 232

6. Switched Access Service (Cont'd)

6.6 Obligations of the Customer

In addition to the obligations of the customer set forth in 2. preceding, the customer has certain specific obligations pertaining to the use of Switched Access Service. These obligations are as follows:

6.6.1 Report Requirements

Customers are responsible for providing the following reports to the Telephone Company, when applicable.

(A) Jurisdictional Reports

When a customer orders Switched Access Service for both interstate and intrastate use, the customer is responsible for providing reports as set forth in 2.3.14 preceding. Charges will be apportioned in accordance with those reports. The method to be used for determining the interstate charges is set forth in 2.3.15 preceding.

(B) Code Screening Reports

When a customer orders service class routing, it must report the number of trunks and/or the appropriate codes to be instituted in each end office or access tandem switch.

(C)

(D)

PUBLIC SERVICE COMMISSION  
OF KENTUCKY  
EFFECTIVE

MAY 1 1993

(D)

PURSUANT TO 807 KAR 5:011,  
SECTION 9 (1)

BY: Sharon Helle  
PUBLIC SERVICE COMMISSION MANAGER

Issued: March 25, 1993

Effective: May 1, 1993

Robert E. Aigmon for

President, Cincinnati, Ohio

Vice President - Regulatory Affairs

ACCESS SERVICE TARIFF  
PSCK No. 2

CINCINNATI BELL TELEPHONE COMPANY

Original Page 233

6. Switched Access Service (Cont'd)

6.6 Obligations of the Customer (Cont'd)

6.6.1 Report Requirements (Cont'd)

(D) 900 Access Service NXX Code Reports

When ordering 900 Access Service, the customer must report the appropriate NXX code(s) to be instituted in each Telephone Company office at which the customer identification function is performed. The report must be updated by the customer each time a change is scheduled to occur, i.e., when a new code is to be added or an existing code is to be deleted. Such updated reports shall be provided at least 30 calendar days prior to the effective date of the change in order to allow the Telephone Company sufficient time to implement the change.

(E) Substantial Call Volume 900 Services

When a customer offers services for which a substantial call volume is expected during a short period of time (e.g., media stimulated events), the customer must notify the Telephone Company at least 24 hours in advance of each peak period. For events scheduled during weekends or holidays, the Telephone Company must be notified no later than 5:00 p.m. local time the second prior business day. Notification should include the nature, time, duration, and frequency of the event, an estimated call volume, and the 900 NXX line number(s) to be used.

On the basis of the information provided, the Telephone Company may invoke network management controls if required to reduce the probability of excessive network congestion. The Telephone Company will work cooperatively with the customer to determine the appropriate level of such control.

Failure to provide prescribed notification may result in customer caused network congestion, which could result in discontinuation of service under paragraph 2.2.2 and/or damages under paragraph 2.3.1.

PUBLIC SERVICE COMMISSION  
OF KENTUCKY  
EFFECTIVE

MAR 3 1992

PURSUANT TO 807 KAR 5:011,

SECTION 9 (1)

Effective: March 3, 1992

BY:   
PUBLIC SERVICE COMMISSION MANAGER

Issued: February 7, 1992

 for President, Cincinnati, Ohio

Vice President - Regulatory Affairs

ACCESS SERVICE TARIFF  
PSC No. 2

CINCINNATI BELL TELEPHONE COMPANY

1st Revised Page 234  
Cancels Original Page 234

6. Switched Access Service (Cont'd)

6.6 Obligations of the Customer (Cont'd)

6.6.2 Supervisory Signaling

The customer's facilities shall provide the necessary on-hook, off-hook, answer and disconnect supervision.

6.6.3 Trunk Group Measurement Reports

With the agreement of the customer, trunk group data in the form of usage in hundred call seconds, peg count and overflow for its end of all access trunk groups, where technologically feasible, will be made available to the Telephone Company. These data will be used to monitor trunk group utilization and service performance and will be based on previously arranged intervals and format. (T)

6.6.4 Design of Switched Access Services

When a customer orders Switched Access Service on a per line or per trunk basis, it is the customer's responsibility to assure that sufficient access services have been ordered to handle its traffic.

PUBLIC SERVICE COMMISSION  
OF KENTUCKY  
EFFECTIVE

OCT 26 1992

Issued: September 24, 1992

PURSUANT TO 807 KAR 5:011.  
EFFECTIVE October 26, 1992

Robert E. Aigson for President, Cincinnati, Ohio BY: George J. Miller  
PUBLIC SERVICE COMMISSION MANAGER

Vice President - Regulatory Affairs

6. Switched Access Service (Cont'd)

6.7 Rate Regulations

This section contains the specific regulations governing the rates and charges that apply for Switched Access Service.

6.7.1 Description and Application of Rates and Charges

There are four types of rates and charges that apply to switched Access Service. These are monthly recurring rates, usage rates, nonrecurring charges and payment plans for MercNET 1.544 (DS1) service. These rates and charges are applied differently to the various rate elements as set forth in (D) following. (T) (C)

(A) Monthly Rates

Monthly rates are flat recurring rates that apply each month or fraction thereof that a specific rate element is provided. For billing purposes, each month is considered to have 30 days.

(B) Usage Rates

Usage rates are rates that apply only when a specific rate element is used. These are applied on a per occurrence (e.g., query access minute fixed and per mile) basis. Usage rate charges are accumulated over a monthly period.

(C) Nonrecurring charges

Nonrecurring charges are one-time charges that apply for a specific work activity (i.e., installation or change to an existing service). The types of nonrecurring charges that apply for Switched Access Service are: installation of service, service rearrangements, and 500 and 900 Access Service charges. (C)

(1) Installation of Service

Nonrecurring charges apply to each Switched Access Service installed as follows:

- . Per line or per trunk
- . Per entrance facility (Voice Grade, DS1, or DS3)
- . Per multiplexer ordered

ACCESS SERVICE TARIFF  
PSC No. 2

CINCINNATI BELL TELEPHONE COMPANY

Original Page 235.1

6. Switched Access Service (Cont'd)

6.7.1 Description and Application of Rates and Charges (Cont'd)

(D) Payment Plans for MercNET 1.544 (DS1) Service

(N)

The Optional Payment Plan (OPP) is a provision that allows a customer to pay a fixed rate for specific MercNET 1.544 (DS1) Service over a 36 or 60 month payment period. During the effective term, monthly rates for services installed under this arrangement will not be subject to Telephone Company initiated rate changes.

MercNET 1.544 (DS1) rates and charges for which the OPP is available are listed in 6.8.2 following.

During a customer's OPP term, the customer shall pay current rates provided they do not exceed the original rate contracted for by the customer, and conversion may be made to a new OPP term of the same or different length. If the expiration date for the new service or OPP term is beyond the end of the original OPP term, the remaining OPP charges for the original term will not apply.

At the expiration of the OPP term and if the customer wishes to continue MercNET 1.544 (DS1) Service the customer may elect:

- Prevailing month-to-month tariff rates
- A new OPP at the prevailing OPP rate, if available

The customer continues to receive the OPP rate on a month-to-month basis for a period of up to six months following the completion of the term. After the six months, the rates will automatically revert to the month-to-month rates.

(N)

ACCESS SERVICE TARIFF  
PSC No. 2

CINCINNATI BELL TELEPHONE COMPANY

Original Revised Page 235.2

6. Switched Access Service (Cont'd)

6.7.1 Description and Application of Rates and Charges (Cont'd)

(D) Payment Plan for MercNET 1.544 (DS1) Service (Cont'd)

During an OPP term, a customer may move one Entrance Facility service to another location while keeping the OPP in force, provided the customer and customer's end user remain the same and no lapse in service occurs.

The Minimum Period for service provided under an OPP is the same as the OPP term selected by the customer (i.e. 36 or 60 month payment period). The Minimum Period for service provided under the month-to-month payment arrangement is 1 month for MercNET 1.544 (DS1).

Customers requesting termination of service prior to the expiration date of the Minimum Period will be liable for payment of a Minimum Period Charge. The Minimum Period Charge for all OPP terms will be calculated as follows:

- The service that is in place less than 12 months the customer would pay the monthly rate for the service.
- The dollar difference between (a) the current OPP rate for the OPP term that could have been completed during the time the service was actually in service, and (b) the customer's current OPP rate for each month the service was provided.

For example, a customer subscribed to a 60 month OPP term and disconnected service during the 39th month. This customer's minimum period charge would be:

$[36 \text{ month OPP rate} - 60 \text{ month OPP rate}] \times 39 = \text{Minimum Period Charge.}$

The 36 month OPP term could have been completed during the months the service was actually in service.

All minimum period charges will be based on the OPP rates in effect at the time of termination.

(N)

ACCESS SERVICE TARIFF  
PSCK No. 2

CINCINNATI BELL TELEPHONE COMPANY

1st Revised Page 236  
Cancels Original Page 236

6. Switched Access Service (Cont'd)

6.7 Rate Regulations (Cont'd)

6.7.1 Description and Application of Rates and Charges (Cont'd)

(C) Nonrecurring Charges (Cont'd)

(1) Installation of Service (Cont'd)

(2) Service Rearrangements

Service rearrangements are changes to existing services installed which do not result in either a change in the minimum period requirements as set forth in 5.2.5 preceding or a change in the physical location of the point of termination at a customer's premises or a customer's end user's premises. Changes which result in the establishment of new minimum period obligations are treated as disconnects and starts. Changes in the physical location of the point of termination are treated as moves and are described and charged for as set forth in 6.7.7 following.

The charge to the customer for the service rearrangement is dependent on whether the change is administrative only in nature or involves an actual physical change to the service.

Administrative changes will be made without charge(s) to the customer. Such changes require the continued provision and billing of the Access Service to the same entity (i.e., customer remains responsible for all outstanding indebtedness for the Access Service). Administrative changes are as follows:

- Change of customer name (i.e., the customer of record does not change but rather the customer of record changes its name--e.g., AT&T-Long Lines to AT&T-Communications)

Issued: June 13, 1995

Effective: May 23, 1995

  
Deborah A. Nisch, President, Cincinnati, Ohio  
Vice President  
Integrated Corporate Planning for

PUBLIC SERVICE COMMISSION  
OF KENTUCKY  
EFFECTIVE  
MAY 23 1995  
PURSUANT TO 807 KAR 5.011,  
SECTION 9(1)  
BY: Jordan C. Neal  
FOR THE PUBLIC SERVICE COMMISSION

(D)  
|  
(D)

6. Switched Access Service (Cont'd)

6.7 Rate Regulations (Cont'd)

6.7.1 Description and Application of Rates and Charges (Cont'd)

(C) Nonrecurring Charges (Cont'd)

(2) Service Rearrangements (Cont'd)

- Change of customer or customer's end user premises address when the change of address is not a result of a physical relocation of equipment,
- Change in billing data (name, address, or contact name or telephone number),
- Change of customer circuit identification,
- Change of billing account number,
- Change of customer test line number,
- Change of customer or customer's end user contact name or telephone number, and
- Change of jurisdiction.

All other service rearrangements will be charged for as follows:

- If, due to technical limitations of the Telephone Company a customer could not combine its 500, 800 Access Service traffic and/or 900 Access Service traffic with its other trunk side Switched Access Service, no charge will apply to combine these trunk groups when it becomes technically possible. (C)
- If the change involves the conversion of existing Feature Group D service with multifrequency address signaling to Feature Group D with the CCSAC option, a service rearrangement charge, as set forth in 6.8.2, will apply for the first trunk converted in a trunk group, and an additional trunk rearrangement charge, as set forth in 6.8.2, will apply for each additional trunk in the same trunk group.



ACCESS SERVICE TARIFF  
PSCK No. 2

CINCINNATI BELL TELEPHONE COMPANY

3rd Revised Page 238  
Cancels 2nd Revised Page 238

6. Switched Access Service (Cont'd)

6.7 Rate Regulations (Cont'd)

6.7.1 Description and Application of Rates and Charges (Cont'd)

(C) Nonrecurring Charges (Cont'd)

(2) Service Rearrangements (Cont'd)

(T)

- For all other changes, including the addition of, or modifications to, optional features a charge equal to the Switched Transport nonrecurring (i.e., installation) charge will apply. When an optional feature is not required on each transmission path, but rather for an entire transmission path group, an end office or an access tandem switch, only one such charge will apply (i.e., it will not apply per transmission path). When the CCSAC option is elected, the customer may add Calling Party Number (CPN), Charge Number (CN), and Carrier Selection Parameter (CSP) at no additional charge if these features are specified at the time the CCSAC option is ordered for existing switched access trunks.

(C)

(C)

(C)

PUBLIC SERVICE COMMISSION  
OF KENTUCKY  
EFFECTIVE

MAY 23 1995

PURSUANT TO 807 KAR 5:011,  
SECTION 3(1)

BY: Jordan C. Neel  
FOR THE PUBLIC SERVICE COMMISSION

Issued: June 13, 1995

Effective: **May 23, 1995**

Deborah A. Nisch President, Cincinnati, Ohio

Vice President  
Integrated Corporate Planning for

6.7 Rate Regulations (Cont'd)

6.7.1 Description and Application of Rates and Charges (Cont'd)

(C) Nonrecurring Charges (Cont'd)

(3) 900 Access Service Charges

A nonrecurring charge as specified in 6.8.2(E) following applies to each change involving the additions or deletions of 900 NXX codes to be routed to a customer in the operating territory of the Telephone Company. For each Telephone Company End Office Switch or Access Tandem in which translation changes are required to route 900 NXX calls to the customer, a one-time charge applies. Additional charges apply for the initial loading of each 900 NXX calls to the customer, a one-time charge applies. Additional charges apply for the initial loading of each 900 NXX code required to establish service and to any subsequent changes to these codes. This includes changing from or to 0+900, as specified in 6.8.10. If the changed 900 NXX codes are used for both interstate and intrastate 900 Access Service, a charge based on the regulations set forth in 2.3.15 preceding applies.

(4) 500 Access Service Charges

For each Telephone Company End Office Switch or Access Tandem in which translation changes are required to route 500 N)0( calls to the customer, a one-time charge applies. Additional charges apply for the initial loading of each 500 NXX code required to establish service and to any subsequent changes to these codes. This includes changing from or to 0+500, as specified in 6.8.11.

(5) Signaling for Tandem Switching

A nonrecurring charge as specified in 6.8.2(H) following applies when a TSP request signaling information for the provision of tandem switching. The nonrecurring signaling charge applies per CIC routed over a TSP's trunk group, by Telephone Company end office.

(D) Application of Rates

Customers are assessed Switched Transport, Local Switching and Information Surcharge Access rates.

(N)

(N)

ACCESS SERVICE TARIFF  
PSCK No. 2

CINCINNATI BELL TELEPHONE COMPANY

1st Revised Page 240  
Cancels Original Page 240

6. Switched Access Service (Cont'd)

6.7 Rate Regulations (Cont'd)

6.7.2 Minimum Periods

Switched Access Service is provided for a minimum period of one month for Feature Groups A, B and D. (C)

6.7.3 Reserved

PUBLIC SERVICE COMMISSION  
OF KENTUCKY  
EFFECTIVE

MAY 23 1995

PURSUANT TO 807 KAR 5.011,  
SECTION 9 (1)

BY: Jordan C. Neal  
FOR THE PUBLIC SERVICE COMMISSION

Issued: **June** 13, 1995

Effective: **May** 23, 1995

 President, Cincinnati, Ohio  
Vice President  
Integrated Corporate Planning for

ACCESS SERVICE TARIFF  
PSCK No. 2

CINCINNATI BELL TELEPHONE COMPANY

2nd Revised Page 241  
Cancels 1st Revised Page 241

6. Switched Access Service (Cont'd)

6.7 Rate Regulations (Cont'd)

6.7.4 Minimum Monthly Charge

Switched Access Service is subject to a minimum monthly charge. The minimum charge applies for the total capacity provided. The minimum monthly charge consists of the following elements:

The minimum monthly charge for the Tandem Switched Transmission, Tandem-Switching, Interconnection charge, Local Switching and the Information Surcharge is the sum of the charges set forth in 6.8.2, 6.8.3, and 6.8.8 following for the measured usage for the month.

The minimum monthly charge for Entrance facilities and Direct Trunked Transport rate elements is the sum of the charges set forth in 6.8.2 following.

(D)

|

(D)

ACCESS SERVICE TARIFF  
PSCK No. 2

CINCINNATI BELL TELEPHONE COMPANY

2nd Revised Page 242  
Cancels 1st Revised Page 242

6. Switched Access Service (Cont'd)

6.7 Rate Regulations (Cont'd)

(D)

PUBLIC SERVICE COMMISSION  
OF KENTUCKY  
EFFECTIVE

MAY 23 1995

PURSUANT TO 807 KAR 5:011,  
SECTION 9(1)

BY: Jordan C. Neal  
FOR THE PUBLIC SERVICE COMMISSION

Issued: June 13, 1995

Effective: **May** 23, 1995

Deborah A. Nisch President, Cincinnati, Ohio  
Vice President  
Integrated Corporate Planning for

6. Switched Access Service (Cont'd)

6.7 Rate Regulations (Cont'd)

6.7.5 Rates Zones

(N)

Rate zones are applicable to Switched Transport services described in this section. Each Telephone Company Wire Center has been assigned to a rate zone as described in Section 18. following. Entrance Facility rates are dependent upon the zone assignment of the Serving Wire Center. Direct Transport Channel Mileage Fixed and Per Mile rates are dependent upon the zone assignment of the Serving Wire Center or the Telephone Company access tandem or the end office. Tandem Switched Transmission and Tandem Switching rates are dependent upon the zone assignment of the Telephone Company access tandem and the end office. Direct Transport and Tandem Switched Transmission mileage that is computed between wire centers in different rate zones will be assigned the rates in the higher rate zone. Multiplexing rates will be determined by the location of the multiplexing arrangement. Tandem Switching rates will be determined by

ACCESS SERVICE TARIFF  
PSCK No. 2

CINCINNATI BELL TELEPHONE COMPANY

1st Revised Page 244  
Cancels Original Page 244

6. Switched Access Service (Cont'd)

6.7 Rate Regulations (Cont'd)

6.7.6 Change of Feature Group Type

Changes from one type of Feature Group to another will be treated as a discontinuance of one type of service and a start of another. Nonrecurring charges will apply, with two exceptions:

(A) When a customer upgrades a Feature Group A or B service to a Feature Group D service, the nonrecurring charge will not apply if the following conditions are met:

- (1) The same customer premises is maintained, and
- (2) The orders for the disconnect of the FGA or FGB service and the start of FGD service are placed with the Telephone Company at the same time, and
- (3) The customer requests the FGA or FGB service be disconnected no more than 90 days after the start of the FGD service.

(B) At the time a customer upgrades a service from Feature Group A, B, or C to Feature Group D, the customer may also change the facility's connection type (e.g., Voice Grade to DS1) or facility type (e.g., Direct-Trunked Transport to Tandem-Switched Transport) or both, at no additional charge.

(N)  
|  
(N)

PUBLIC SERVICE COMMISSION  
OF KENTUCKY  
EFFECTIVE

MAY 23 1995

PURSUANT TO 807 KAR 5.011,  
SECTION 9(1)

BY: Jordan C. Neal  
FOR THE PUBLIC SERVICE COMMISSION

Issued: June 13, 1995

Effective: May 23, 1995

*Deborah A. Nisch* President, Cincinnati, Ohio  
Vice President  
Integrated Corporate Planning for

ACCESS SERVICE TARIFF  
PSCK No. 2

CINCINNATI BELL TELEPHONE COMPANY

Original Page 245

6. Switched Access Service (Cont'd)

6.7 Rate Regulations (Cont'd)

6.7.6 Change of Feature Group Type (Cont'd)

When the effective dates for the disconnect and start of service are the same, minimum period obligations will not change, (i.e., the time elapsed in the existing minimum period obligations will be credited to the minimum period obligations for FGD). When the effective dates for the disconnect and start of service are different, new minimum period obligations will be established for the FGD service. For all other changes from one type of Feature Group to another, new minimum period obligations will also be established.

6.7.7 Moves

A move involves a change in the physical location of one of the following:

- The point of termination at the customer's premises
- The customer's premises

The charges for the move are dependent on whether the move is to a new location within the same building or to a different building.

PUBLIC SERVICE COMMISSION  
OF KENTUCKY  
EFFECTIVE

MAR 3 1992

PURSUANT TO 807 KAR 5:011,  
SECTION 9(1)

Issued: February 7, 1992

Effective: *March 3, 1992*  
PUBLIC SERVICE COMMISSION MANAGER

*Robert E. Aigmon* for President, Cincinnati, Ohio

**Vice President - Regulatory Affairs**



ACCESS SERVICE TARIFF  
PSC No. 2

CINCINNATI BELL TELEPHONE COMPANY

2nd Revised Page 246  
Cancels 1st Revised Page 246

6. Switched Access Service (Cont'd)

6.7 Rate Regulations (Cont'd)

6.7.7 Moves (Cont'd)

All Moves will be treated as a discontinuance and start of service and all associated nonrecurring charges will apply. ~~New~~ minimum period requirements will be established for the new services. The customer will also remain responsible for satisfying all outstanding minimum period charges for the discontinued services.

6.7.8 Measuring Access Minutes

Customer traffic to end offices will be measured by the Telephone Company at end office switches or access tandem switches. Originating and terminating calls will be measured by the Telephone Company to determine the basis for computing chargeable access minutes.

For terminating calls over FGA, FGB to 500, 800 and/or 900, and FGD, (C) and for originating calls over FGA, where the off-hook supervisory signal is provided by the customer's equipment, FGB and FGD, the measured minutes are the chargeable access minutes.

For originating calls over 500, 800, and 900 Access Service, (C) and (C) over FGA where the off-hook supervisory signal is forwarded by the customer's equipment when the called party answers, chargeable originating access minutes are derived from recorded minutes in the following manner.

6. Switched Access Service (Cont'd)

6.7 Rate Regulations (Cont'd)

6.7.8 Measuring Access Minutes (Cont'd)

Step 1: Obtain recorded originating minutes and messages (measured as set forth in (A) following for FGA where the off-hook supervisory signal is forwarded by the customer's equipment when the called party answers) from the appropriate recording data. (T)

Step 2: Obtain the total attempts by dividing the originating measured messages by the completion ratio Completion ratios (CR) are obtained separately for the major call categories such as DDD, operator, 500, 800, 900, directory assistance and international from a sample study which analyzes the ultimate completion status of the total attempts which receive acknowledgement from the customer. That is, Measured Messages divided by Completion Ratio equals Total Attempts. (C)

Step 3: Obtain the total non-conversation time additive (NCTA) by multiplying the total attempts (obtained in Step 2) by the NCTA per attempt ratio. The NCTA per attempt ratio is obtained from the sample study identified in Step 2 by measuring the non-conversation time associated with both completed and incompletd attempts. The total NCTA is the time on a completed attempt from customer acknowledgment of receipt of call to called party answer (set up and ringing) plus the time on an incompletd attempt from customer acknowledgement of call until the access tandem or end office receives a disconnect signal (ring - no answer, busy or network blockage). That is, Total Attempts times NonConversation Time per Attempt Ratio equals Total NCTA.

Step 4: Obtain total chargeable originating access minutes by adding the total NCTA (obtained in Step 3) to the recorded originating measured minutes (obtained in Step 1). That is, Measured Minutes plus NCTA equals Chargeable Originating Access Minutes.

ACCESS SERVICE TARIFF  
PSCK No. 2

CINCINNATI BELL TELEPHONE COMPANY

Original Page 248

6. Switched Access Service (Cont'd)

6.7 Rate Regulations (Cont'd)

6.7.8 Measuring Access Minutes (Cont'd)

Following is an example which illustrates how the chargeable originating access minutes are derived from the measured originating minutes using this formula.

Where: Measured Minutes (M. Min.) = 7,000  
Measured Messages (M. Mes.) = 1,000  
Completion Ratio (CR) = .75  
NCTA per Attempt = .4

$$(1) \text{ Total Attempts} = \frac{1,000(\text{M. Mes.})}{.75 (\text{CR})} = 1,333.33$$

$$(2) \text{ Total NCTA} = .4 (\text{NCTA per Attempt}) \times 1,333.33 = 533.33$$

$$(3) \text{ Total Chargeable Originating Access Minutes} = 7,000(\text{M. Min}) + 533.33(\text{NCTA}) = 7,533.33$$

FGA, FGB and FGD access minutes or fractions thereof are accumulated over the billing period. The exact value of the fraction is a function of the switch technology where the measurement is made. FGA access minutes are accumulated for each line or hunt group and FGB and FGD access minutes are accumulated for each end office.

When determining chargeable access minutes the accumulated access minutes or fractions thereof are rounded up to the nearest access minute. For rate elements where the charge is based on 100 access minutes, e.g., Information Surcharge, fractional portions of 100 access minutes are considered to be 100 access minutes.

PUBLIC SERVICE COMMISSION  
OF KENTUCKY  
EFFECTIVE

MAR 3 1992

PURSUANT TO 807 KAR 5:011,  
SECTION 3 (1)

Issued: February 7, 1992

Effective: March 3, 1992  
PUBLIC SERVICE COMMISSION MANAGER

*Robert E. Aigner* for President, Cincinnati, Ohio

Vice President - Regulatory Affairs

ACCESS SERVICE TARIFF  
PSCK No. 2

CINCINNATI BELL TELEPHONE COMPANY

Original Page 249

6. Switched Access Service (Cont'd)

6.7 Rate Regulations (Cont'd)

6.7.8 Measuring Access Minutes (Cont'd)

(A) Feature Group A Usage Measurement

For originating calls over FGA, usage measurement begins when the originating FGA entry switch receives an off-hook supervisory signal forwarded from the customer's point of termination. This off-hook signal is either provided by the customer's equipment or is forwarded by the customer's equipment when the called party answers.

The measurement of originating call usage over FGA ends when the originating FGA entry switch receives an on-hook supervisory signal from either the originating end user's end office, indicating the originating end user has disconnected, or the customer's point of termination, whichever is recognized first by the entry switch.

For terminating calls over FGA, usage measurement begins when the terminating FGA entry switch receives an off-hook supervisory signal from the terminating end user's end office, indicating the terminating end user has answered. The measurement of terminating call usage over FGA ends when the terminating FGA entry switch receives an on-hook supervisory signal from either the terminating end user's end office, indicating the terminating end user has disconnected, or the customer's point of termination, whichever is recognized first by the entry switch.

(B) Feature Group B Usage Measurement

For originating calls over FGB, usage measurement begins when the originating FGB entry switch receives answer supervision forwarded from the customer's point of termination, indicating the customer's equipment has answered.

PUBLIC SERVICE COMMISSION  
OF KENTUCKY  
EFFECTIVE

MAR 3 1992

PURSUANT TO 807 KAR 5:011,  
SECTION 9 (1)

Issued: February 7, 1992

Effective: March 3, 1992

*Robert E. Sigmon* for President, Cincinnati, Ohio

BY: *[Signature]*  
PUBLIC SERVICE COMMISSION MANAGER

Vice President - Regulatory Affairs

ACCESS SERVICE TARIFF  
PSCK No. 2

CINCINNATI BELL TELEPHONE COMPANY

Original Page 250

6. Switched Access Service (Cont'd)

6.7 Rate Reulations (Cont'd)

6.7.8 Measuring Access Minutes (Cont'd)

(B) Feature Group B Usage Measurement (Cont'd)

The measurement of originating call usage over FGB ends when the originating FGB entry switch receives disconnect supervision from either the originating end user's end office, indicating the originating end user has disconnected, or the customer's point of termination, whichever is recognized first by the entry switch.

For terminating calls over FGB, usage measurement begins when the terminating FGB entry switch receives answer supervision from the terminating end user's end office, indicating the terminating end user has answered.

The measurement of terminating call usage over FGB ends when the terminating FGB entry switch receives disconnect supervision from either the terminating end user's end office, indicating the terminating end user has disconnected, or the customer's point of termination, whichever is recognized first by the entry switch.

**PUBLIC SERVICE COMMISSION  
OF KENTUCKY  
EFFECTIVE**

MAR 3 1992

**PURSUANT TO 807 KAR 5:011,  
SECTION 9 (1)**

BY: *Robert E. Sigerson*  
PUBLIC SERVICE COMMISSION MANAGER

Issued: February 7, 1992

Effective: March 3, 1992

*Robert E. Sigerson* for President, Cincinnati, Ohio

Vice President - Regulatory Affairs

ACCESS SERVICE TARIFF  
PSCK No. 2

CINCINNATI BELL TELEPHONE COMPANY

1st Revised Page 251  
Cancels Original Page 251

6. Switched Access Service (Cont'd)

6.7 Rate Regulations (Cont'd)

6.7.8 Measuring Access Minutes (Cont'd)

(C) Feature Group D Usage Measurement

For originating calls over FGD with multifrequency address signaling, usage measurement begins when the originating FGD entry switch receives the first wink supervisory signal forwarded from the customer's point of termination. For originating calls over FGD with CCSAC, usage measurement begins when the last point of switching sends the initial address message to the customer. (C)

The measurement of originating call usage over FGD ends when the originating FGD entry switch receives disconnect supervision from either the originating end user's end office, indicating the originating end user has disconnected, or the customer's point of termination, whichever is recognized first by the entry switch. (C)

For terminating calls over FGD, the measurement of access minutes begins when the terminating FGD entry switch receives answer supervision from the terminating end user's end office, indicating the terminating end user has answered. (C)

The measurement of terminating call usage over FGD ends when the terminating FGD entry switch receives disconnect supervision from either the terminating end user's end office, indicating the terminating end user has disconnected, or the customer's point of termination, whichever is recognized first by the entry switch.

**PUBLIC SERVICE COMMISSION  
OF KENTUCKY  
EFFECTIVE**

OCT 26 1992

**PURSUANT TO 807 KAR 5:011,  
SECTION 9 (1)**

Issued: September 24, 1992

BY: *[Signature]* 26, 1992  
PUBLIC SERVICE COMMISSION MANAGER

*Robert E. Sigmon* for President, Cincinnati, Ohio

**Director - Regulatory Affairs**

ACCESS SERVICE TARIFF  
PSCK No. 2

CINCINNATI BELL TELEPHONE COMPANY

1st Revised Page 252  
Cancels Original Page 252

6. Switched Access Service (Cont'd)

6.7 Rate Regulations (Cont'd)

6.7.9 Network Blocking Charge for Feature Group D

The customer will be notified by the Telephone Company to increase its capacity (quantities of trunks) when excessive trunk group blocking occurs on groups carrying Feature Group D traffic and the measured access minutes for that hour exceed the capacity purchased. Excessive trunk group blocking occurs when the blocking thresholds stated below are exceeded. They are predicated on time consistent, hourly measurements over a 30 day period excluding Saturdays, Sundays and national holidays. If the order for additional capacity has not been received by the Telephone Company within 15 days of the notification, the Telephone Company will bill the customer, at the rate set forth in 6.8.2(D) following, for each overflow in excess of the blocking threshold when (1) the average "30 day period" overflow exceeds the threshold level for any particular hour and (2) and "30 day period" measured average originating or two-way usage for the same clock hour exceeds the capacity purchased.

(C)

PUBLIC SERVICE COMMISSION  
OF KENTUCKY  
EFFECTIVE

Blocking Thresholds

|  | <u>Trunks in Service</u> | <u>1%</u> | <u>1/2%</u> |
|--|--------------------------|-----------|-------------|
| MAY 23 1995  | 1-2                      | .070      | .045        |
| PURSUANT TO 807 KAR 5:011<br>SECTION 9(1)                      | 3-4                      | .050      | .035        |
| BY: <u>Jordan C. Neal</u><br>FOR THE PUBLIC SERVICE COMMISSION | 5-6                      | .040      | .025        |
|  | 7 or greater             | .030      | .020        |

The 1% blocking threshold is for transmission paths carrying traffic direct (without an alternate route) between an end office and a customer's premises. The 1/2% blocking threshold is for transmission paths carrying first routed traffic between an end office and a customer's premises via an access tandem.

Issued: **June 13, 1995**

Effective: **May 23, 1995**

Deborah A. Nisich President, Cincinnati, Ohio

Vice President  
Integrated Corporate Planning for

ACCESS SERVICE TARIFF  
PSCK No. 2

CINCINNATI BELL TELEPHONE COMPANY

Original Page 253

6. Switched Access Service (Cont'd)

6.7 Rate Regulations (Cont'd)

6.7.10 Application of Rates for Extension Service

Feature Group A Switched Access Service is available with extension(s), i.e., additional termination(s) of the service in different building(s) in the same or different LATA(s). Feature Group A extension(s) in the same LATA and same state are charged for under the Telephone Company's local and/or general exchange service tariffs. Feature Group A extension(s) in different LATA(s) or in a different state in the same LATA are charged for as Special Access Service. The rate elements which apply are: A Voice Grade Channel Termination, Channel Mileage, if applicable, and Signaling Capability, if applicable. All appropriate monthly rates and nonrecurring charges set forth in 7.5.3 following will apply. Such extensions are ordered as set forth in 5.2 preceding.

PUBLIC SERVICE COMMISSION  
OF KENTUCKY  
EFFECTIVE

MAR 3 1992

PURSUANT TO 807 KAR 5:011,  
SECTION 9 (1)

Issued: February 7, 1992

Effective: March 3, 1992

*Walter E. Aiguon* for President, Cincinnati, Ohio

*Walter E. Aiguon*  
PUBLIC SERVICE COMMISSION MANAGER

Vice President - Regulatory Affairs



ACCESS SERVICE TARIFF  
PSC No. 2

CINCINNATI BELL TELEPHONE COMPANY

Original Page 254

6. Switched Access Service (Cont'd)

6.7 Rate Regulations (Cont'd)

6.7.11 Message Unit Credit

Calls from end users to the seven digit local telephone numbers numbers associated with Feature Group A Switched Access Service may be subject to Telephone Company local and/or general exchange service tariff charges (including message unit and toll charges as applicable). The monthly bills rendered to customers for their Feature Group A Switched Access Service for which Carrier Common Line Charges apply will include a credit to reflect any message unit charges collected from their end users under the Telephone Company's local and/or general exchange service tariffs. The credit will apply for recorded originating usage for the FGA service provided. No credit will apply for any terminating FGA access minutes. The message unit credit for originating FGA access minutes is as set forth in 6.8.6 following.

6.7.12 Local Information Delivery Services

Calls over Switched Access in the terminating direction to certain community information services will be rated under the applicable rates for Switched Access Service as set forth in 6.8 following. In addition, the charges per call as specified under the Telephone Company's local and/or general exchange service tariffs, e.g., 976 (DIAL-IT) Network Services, will also apply.

PUBLIC SERVICE COMMISSION  
OF KENTUCKY  
EFFECTIVE

MAR 3 1992

PURSUANT TO 807 KAR 5.011,  
SECTION 9 (1)

BY: *Charles H. [Signature]*  
Effective: March 3, 1992  
PUBLIC SERVICE COMMISSION MANAGER

Issued: February 7, 1992

*Robert E. Aigmon* for President, Cincinnati, Ohio

Vice President - Regulatory Affairs

ACCESS SERVICE TARIFF  
PSCK No. 2

CINCINNATI BELL TELEPHONE COMPANY

1st Revised Page 255  
Cancels Original Page 255

6. Switched Access Service (Cont'd)

6.7 Rate Regulations (Cont'd)

6.7.13 Mileage Measurement

The mileage to be used to determine the monthly rate for the Switched Transport rate element is calculated on the airline distance between the end office switch where the call carried by Switched Transport originates or terminates and the customer's serving wire center, except as set forth in (A) through (F) following. The V&H coordinates method is used to determine mileage. This method is set forth in the NATIONAL EXCHANGE CARRIER ASSOCIATION TARIFF F.C.C. NO. 4 for Wire Center Information (V&H coordinates).

PUBLIC SERVICE COMMISSION  
OF KENTUCKY  
EFFECTIVE

MAY 23 1995

PURSUANT TO 807 KAR 5011,  
SECTION 9(1)

BY: *Jordan C. Neal*  
FOR THE PUBLIC SERVICE COMMISSION

Exceptions to the mileage measurement rules are as follows:

ties or bandwidths are interconnected by a multiplexer at a location other than the serving wire center, mileage is determined using the V&H coordinates method following:

- (1) When *only* one multiplexer is involved, mileage for Direct-Trunked Transport is measured separately from the serving wire center to the hub where multiplexing occurs and then measured from the hub to the end office where the call is switched to originate or terminate.
- (2) When more than one multiplexer is used, mileage for Direct-Trunked Transport is measured successively from the serving wire center to the first hub, from the first hub to the second hub and then from the second hub to the end office where the call is switched to originate or terminate.

Issued: June 13, 1995

Effective: May 23, 1995

*Deborah A. Nisch* President, Cincinnati, Ohio  
Vice President  
Integrated Corporate Planning for

ACCESS SERVICE TARIFF  
PSCK No. 2

CINCINNATI BELL TELEPHONE COMPANY

2nd Revised Page 256  
Cancels 1st Revised Page 256

6. Switched Access Service (Cont'd)

6.7 Rate Regulations (Cont'd)

6.7.13 Mileage Measurement (Cont'd)

(B)

PUBLIC SERVICE COMMISSION  
OF KENTUCKY  
EFFECTIVE

MAY 23 1995

PURSUANT TO 807 KAR 5.011,  
SECTION 9 (1)

BY: Jordan C. Neal  
FOR THE PUBLIC SERVICE COMMISSION

(D)

(D)

(C) When Direct-Trunked Transport is provided to a Host/Remote arrangement, Direct-Trunked Transport rates apply and mileage is calculated using the V & H coordinate method between the customer's serving wire center and the Host office serving the Remote Office. When Tandem-Switched Transport is provided to a Host/Remote arrangement, Tandem-Switching Transmission rates and Tandem-Switched rates apply. Tandem-Switched Transport mileage is calculated using the V & H coordinate method between the customer's serving wire center and the Host office for both Direct-Trunked Transport and Tandem-Switched Transmission rate will apply separately from the Host office to the Remote office. The Interconnection charge will apply to both Direct and Tandem access minutes of use. Remote end offices are set forth in the National Exchange Carrier Association Tariff F.C.C. No. 4.

(N)

(N)

Certain regulation8 previously found an this page now appears on Page 257.

Issued: June 13, 1995

Effective: May 23, 1995

  
Deborah A. Nisicki, President, Cincinnati, Ohio  
Vice President  
Integrated Corporate Planning for

ACCESS SERVICE TARIFF  
PSCK No. 2

CINCINNATI BELL TELEPHONE COMPANY

1st Revised Page 257  
Cancels Original Page 257

6. Switched Access Service (Cont'd)

6.7 Rate Regulations (Cont'd)

6.7.13 Mileage Measurement (Cont'd)

PUBLIC SERVICE COMMISSION  
OF KENTUCKY  
EFFECTIVE

(D)

MAY 23 1995

PURSUANT TO 807 KAR 5011,  
SECTION 9(1)

BY: Jordan C. Neel  
FOR THE PUBLIC SERVICE COMMISSION

(D)

(D)

(E) The Alternate Traffic Routing optional feature is provided with Feature Group B, C and D to provide service from an end office to different customer premises locations. For Feature Groups B and C and for FGD traffic routed via an access tandem, such apportionment be made *using* standard Telephone Company traffic engineering methodology and will be based on the last trunk hundred call seconds desired for the high usage group, as described in 6.3.1(0) preceding, and the relative capacity ordered to the end office, when the feature is provided at an end office switch, or to the subtending end offices when the feature is provided at an access tandem switch. This apportionment will serve as the basis for the Switched Transport Tandem-Switching Transmission mileage calculation. The customer will be billed accordingly.

(C)

(D)

(D)

(C)

(F) When Direct-Trunked Transport is provided for line side Switched Access Service (i.e., Feature Group A), both Direct-Trunked Transport and Tandem-Switched Transmission rates apply. Direct-Trunked Transport applies to both originating and terminating usage and mileage is calculated *using* the V&H Coordinates method between the customer's serving wire center and the end office switch where the dial tone for the line side Switched Access Service is provided. Tandem-Switched Transmission applies *only* to terminating usage and mileage is calculated *using* the V&H coordinate method between the dial tone office and the end office where the call is switched to terminate.

(N)

(N)

Certain regulations previously found on this page now appear on Page 257.1.  
Certain regulations found on this page previously appeared on Page 256.

Issued: June 13, 1995

Effective: May 23, 1995

Deborah A. Nisch  
President, Cincinnati, Ohio  
Vice President  
Integrated Corporate Planning for

ACCESS SERVICE TARIFF  
PSCR No. 2

CINCINNATI BELL TELEPHONE COMPANY

Original Page 257.1

6. Switched Access Service (Cont'd)

6.7 Rate Regulations (Cont'd)

6.7.13 Mileage Measurement (Cont'd)

- (G) The **Switched** Transport mileage for Feature Group B and D **(C)(T)** Switched Access Service provided to Mobile Telephone Serving Offices (MTSOs) interconnected to a Telephone Company access tandem office will be determined on an airline basis, using the V&H coordinate method. The mileage measured will be that between the Telephone Company access tandem office serving the Mobile Telephone Serving Office (MTSO) and the customer serving wire center.
- (H) The **Switched** Transport mileage for FGA, FGB or FGD access **(C)(T)** minutes which originate from or terminate to a WATS Access Line Service will be calculated on an airline basis using the V&H coordinates method between the WATS Serving Office at which the WATS Access Line Service is provided and the customer premises serving wire center for the Switched Access Service provided.

PUBLIC SERVICE COMMISSION  
OF KENTUCKY  
EFFECTIVE

MAY 23 1995

PURSUANT TO 807 KAR 5.011,  
SECTION 9 (1)  
BY: Jordan C. Neal  
FOR THE PUBLIC SERVICE COMMISSION

Certain regulations found on this page previously appeared on Page 257.

Issued: June 13, 1995

Effective: **May** 23, 1995

*Deborah A. Nisch*  
President, Cincinnati, Ohio  
Vice President  
Integrated Corporate Planning for

ACCESS SERVICE TARIFF  
PSCK No. 2

CINCINNATI BELL TELEPHONE COMPANY

1st Revised Page 258  
Cancels Original Page 258

6. Switched Access Service (Cont'd)

6.7 Rate Regulations (Cont'd)

6.7.14 Shared Use

Shared Use occurs **when** Switched Access Service and Special Access Service, including CCSAC signaling connections, are provided **over** the same analog or digital high capacity facility through a common interface.

Shared Use facilities are ordered, provided and rated either as Switched Access or Special Access. Ordering, provisioning and rating of Special Access Shared Use facilities is set forth in 7.4.8 following. Ordering, provisioning and rating of Switched Access Shared Use facilities is as follows.

(A) Switched Access facilities are ordered, provided and rated as Switched Access only in cases where the facility is used for Switched Access only. In the event that a Special Access circuit is added to a switched facility, the facility will then be provisioned as a special access facility.

(B) When ordered as Switched Access, the nonrecurring charges that apply when the Switched Access Shared Use facility is installed will be the nonrecurring charges associated with the Switched Access Transport being ordered.

(C) The customer must place an order for each individual Switched or Special Access service using the Shared Use facility and **must** also specify the channel assignment for each service.

(D) When shared use occurs and the facility becomes a Special Access facility, the monthly recurring rates for Special and Switched Access will be based upon the percentage of channels associated with each.

(C)

(C)

PUBLIC SERVICE COMMISSION  
OF KENTUCKY  
EFFECTIVE

MAY 23 1995

PURSUANT TO 807 KAR 5:011,  
SECTION 9 (1)

BY: Jordan C. Neel (D)  
FOR THE PUBLIC SERVICE COMMISSION

Certain regulations previously found on this page nor appears on Page 258.1.

Issued: June 13, 1995

Effective: May 23, 1995

Deborah A. Nisicki President, Cincinnati, Ohio  
Vice President  
Integrated Corporate Planning for

6. Switched Access Service (Cont'd)

6.7 Rate Regulations (Cont'd)

6.7.14 Shared Use

- (E) When shared use of a facility occurs in a Host/Remote situation, the facility must route to the Host end office. The Telephone Company will continue to provide shared use to any end office so long as capabilities exist.
- (F) Channels being used in conjunction with CCSAC may be included as Shared Use. However, CCSAC signaling connections nonrecurring charges will not apply to the individual channels of the shared use facility.

—  
|  
(D)

ACCESS SERVICE TARIFF  
PSC No. 2

CINCINNATI BELL TELEPHONE COMPANY

1st Revised Page 259  
Cancels Original Page 259

6. Switched Access Service (Cont'd)

6.7 Rate Regulations (Cont'd)

6.7.16 Information Surcharae

The Information Surcharge is a charge to recover costs that have been assigned to the interstate Information category through Parts 67 and 69 of the Federal Communications Commission's Rules. These costs are other than those incurred in the provision of interstate Directory Assistance Service as set forth in 9. following.

The Information Surcharge is assessed to the customer based on the total number of access minutes. The rates are set forth in 6.8.8 following. The application of these rates is as set forth in 6.7.1(D) preceding.

6.7.17 Data Base Query

A Data Base Query charge as set forth in 6.8.3(A)(2) applies for each data base query that returns a valid carrier identification code that provides the appropriate routing information even if the call is not completed. When additional routing options (i.e., alternate carrier(s) and/or alternate destination(s) identified based on criteria such as; time of day, day-of-week, specific dates, originating NPA-NXX, percent allocation, routing to a single carrier and destination from an area of service smaller than an area defined by an NPA-NXX) are performed, a Routing Options Capability charge as set forth in 6.8.3(A)(2) will also apply per query.

(N)  
|  
(N)

**PUBLIC SERVICE COMMISSION  
OF KENTUCKY  
EFFECTIVE**

**MAY 1 1993**

**PURSUANT TO 807 KAR 5:011,  
SECTION 9 (1)**

BY: *Sharon Hella*  
PUBLIC SERVICE COMMISSION MANAGER

Issued: March 25, 1993

Effective: May 1, 1993

*Robert E. Aiguon* for

President, Cincinnati, Ohio

**Vice President - Regulatory Affairs**



ACCESS SERVICE TARIFF  
PSC No. 2

CINCINNATI BELL TELEPHONE COMPANY

3rd Revised Page 260  
Cancels 2nd Revised Page 260

6. Switched Access Service (Cont'd)

6.8 Rates and Charges

6.8.1 Interconnection Charge

Rate Per Access Minute

|   |  |            |     |
|---|--|------------|-----|
| Originating transport-provided access     |  |            |     |
| Premium                                   |  | \$ .000000 | (R) |
| Transitional                              |  | .000000    | (R) |
| Terminating transport-provided access     |  |            |     |
| Premium                                   |  | .000000    | (R) |
| Transitional                              |  | .000000    | (R) |
| Originating non-transport provided access |  |            | (N) |
| Premium                                   |  | ,0005916   |     |
| Transitional                              |  | ,0002958   |     |
| Terminating non-transport provided access |  |            |     |
| Premium                                   |  | .000000    |     |
| Transitional                              |  | .000000    |     |

6.8.2 Switched Transport

USOC

Monthly Rates      Nonrecurring Charges

|                            |       |               |      |     |
|----------------------------|-------|---------------|------|-----|
| (A) Entrance Facilities    |       |               |      |     |
| (1) Voice Grade            |       |               |      |     |
| - per point of Termination |       |               |      |     |
| - Two-Wire                 | EF2A2 | \$31.00(R)    | NONE | (R) |
| - Four-Wire                | EF2A4 | \$49.60(R)    | NONE | (R) |
| (2) MercNET 1.544 (DS1)    |       |               |      |     |
| Monthly                    |       |               |      |     |
| Zone - 1                   | EFYBL | \$135.79      |      |     |
| Zone - 2                   | EFYB2 | \$135.79      |      |     |
| Zone - 3                   | EFYB3 | \$135.79      |      |     |
| 36 Monthly                 |       |               |      |     |
| Zone - 1                   | EFYBL | \$129.00      |      | (N) |
| Zone - 2                   | EFYB2 | \$129.00      |      |     |
| Zone - 3                   | EFYB3 | \$129.00      |      |     |
| 60 Monthly                 |       |               |      |     |
| Zone - 1                   | EFYBL | \$122.21      |      |     |
| Zone - 2                   | EFYB2 | \$122.21      |      |     |
| Zone - 3                   | EFYB3 | \$122.21      |      |     |
| (3) MercNET 45 (DS3)       |       |               |      |     |
| Zone 1                     | EFYCL | \$1.800.00(R) | NONE | (C) |
| Zone 2                     | EFYC2 | \$1.800.00(R) | NONE | (N) |
| Zone 3                     | EFYC3 | \$1.800.00(R) | NONE | (N) |

(B) Direct-Trunked Transport

Monthly Rates

|                 |       |             |            |
|-----------------|-------|-------------|------------|
|                 | USOC  | Fixed       | Per Mile   |
| (1) Voice Grade |       |             |            |
| - Two-Wire      | LYTXS | \$ 61.00(I) | \$ 1.25(I) |
| - Four-Wire     | IYTXS | \$ 61.00(I) | \$ 1.25(I) |

Filed in accordance with Case No. 98-292, Order issued July 26 1999.

Issued: September 22, 1999

Effective: January 25, 1999

President, Cincinnati, Ohio

ACCESS SERVICE TARIFF  
PSC No. 2

CINCINNATI BELL TELEPHONE COMPANY

1st Revised Page 260.1  
Cancels Original Page 260.1

6. Switched Access Service (Cont'd)

6.8 Rates and Charges

6.8.2 Switched Transport (Cont'd)

(2) MercNET 1.5 (DS1)

| Monthly, Optional<br>Payment Plan |                               |             | Monthly Rates |                 |
|-----------------------------------|-------------------------------|-------------|---------------|-----------------|
| <u>Mileage Bands</u>              |                               | <u>USOC</u> | <u>Fixed</u>  | <u>Per Mile</u> |
| (a)                               | Zone - 1 <u>Mileage Bands</u> |             |               |                 |
|                                   | 0                             |             |               |                 |
|                                   | Over 0 to 4                   | 1YTX1       | \$113.37      | \$12.50 (R)     |
|                                   | Over 4 to 8                   | 1YTX1       | \$113.37      | \$12.50         |
|                                   | Over 8 to 25                  | 1YTX1       | \$113.37      | \$12.50         |
|                                   | Over 25                       | 1YTX1       | \$113.37      | \$12.50 (R)     |
| (b)                               | Zone - 2 <u>Mileage Bands</u> |             |               |                 |
|                                   | 0                             |             |               |                 |
|                                   | Over 0 to 4                   | 1YTX1       | \$113.37      | \$12.50 (N)     |
|                                   | Over 4 to 8                   | 1YTX1       | \$113.37      | \$12.50         |
|                                   | Over 8 to 25                  | 1YTX1       | \$113.37      | \$12.50         |
|                                   | Over 25                       | 1YTX1       | \$113.37      | \$12.50 (N)     |
| (c)                               | Zone - 3 <u>Mileage Bands</u> |             |               |                 |
|                                   | 0                             |             |               |                 |
|                                   | Over 0 to 4                   | 1YTX1       | \$113.37      | \$12.50 (N)     |
|                                   | Over 4 to 8                   | 1YTX1       | \$113.37      | \$12.50         |
|                                   | Over 8 to 25                  | 1YTX1       | \$113.37      | \$12.50         |
|                                   | Over 25                       | 1YTX1       | \$113.37      | \$12.50 (N)     |
| (3)                               | MercNET 45 (DS3)              |             |               |                 |
|                                   | Zone - 1                      | 1YTX1       | \$800.00(R)   | \$90.00(R)      |
|                                   | Zone - 2                      | 1YTX2       | \$800.00(N)   | \$90.00(N)      |
|                                   | Zone - 3                      | 1YTX3       | \$800.00(N)   | \$90.00(N)      |

Filed in accordance with Case No. 98-292. Order issued July 26, 1999.  
Certain regulations previously on this page now appear on page 260.2.

Issued: September 22, 1999

President, Cincinnati, Ohio

Effective: January 25, 1999

ACCESS SERVICE TARIFF  
 PSCK No. 2

CINCINNATI BELL TELEPHONE COMPANY

Original Page 260.2

6. Switched Access Service (Cont'd)

6.8 Rates and Charges

6.8.2 Switched Transport (Cont'd)

(C) Tandem-Switched Transport

|      |   | <u>Monthly Rates</u> |                               |     |
|------|---|----------------------|-------------------------------|-----|
| USOC |   | <u>Per Mou</u>       | <u>Per Mou. Per Mile</u>      |     |
| (1)  | Tandem-Switched Transmission                  |                      |                               |     |
|      | Zone - 1                                      | \$0.000600(T)        | \$0.000102(T)                 |     |
|      | Zone - 2                                      | \$0.000600(N)        | \$0.000102(N)                 |     |
|      | Zone - 3                                      | \$0.000600(N)        | \$0.000102(N)                 |     |
| (2)  | Tandem-Switching                              |                      |                               |     |
|      | Zone - 1                                      | \$0.0028452(R)       |                               |     |
|      | Zone - 2                                      | \$0.0028452(N)       |                               |     |
|      | Zone - 3                                      | \$0.0028452(N)       |                               |     |
| (3)  | Access Tandem Trunk<br>Port Charge, per trunk |                      | <u>Monthly Rate</u><br>\$6.17 | (N) |

(D) Multiplexing

|     |   |       |   |                 |
|-----|---|-------|---|-----------------|
| (1) | MerNET 1.544 (DS1) to<br>Voice Grade              |       |   |                 |
|     | - Per Arrangement                                 |       |   |                 |
|     | Zone - 1  | MKW11 | \$285.45                                    | (R)             |
|     | Zone - 2  | MKW12 | \$285.45                                    | (N)             |
|     | Zone - 3  | MKW13 | \$285.45                                    | (N)             |
| (2) | MercNET 45 (DS3) to<br>MercNET 1.5 (DS1)          |       |   |                 |
|     | - Per Arrangement                                 |       |   |                 |
|     | Zone - 1  | MKS31 | \$678.02                                    | (R)             |
|     | Zone - 2  | MKW32 | \$678.02                                    | (N)             |
|     | Zone - 3  | MKW33 | \$678.02                                    | (N)             |
| (3) | Tandem Multiplexing<br>(EO Side of Access Tandem) |       | <u>Rate Per Access Minute</u><br>\$0.000240 | (N)<br> <br>(N) |

Filed in accordance with Case No. 98-292. Order issued July 26, 1999.  
 Certain regulations on this page previously appeared on Page 260.1.

Issued: September 22, 1999

Effective: January 25, 1999

President, Cincinnati, Ohio

ACCESS SERVICE TARIFF  
PSCK No. 2

CINCINNATI BELL TELEPHONE COMPANY

2nd Revised Page 261  
Cancels 1st Revised Page 261

6. Switched Access Service (Cont'd)

6.8 Rates and Charges (Cont'd)

6.8.2 Switched Transport (Cont'd)

|     |   | <u>Nonrecurring<br/>Charge</u> | (C) |
|-----|---|--------------------------------|-----|
| (E) | Installation<br>- Per Line or Trunk<br>Signaling Connection | NONE(R)                        | (T) |
|     |   |                                |     |
|     |   | <u>Rate Per Call Blocked</u>   |     |
| (P) | Network Blocking Charge †                                   | \$0.0034(I)                    | (T) |
| (G) | <u>Nonchargeable Optional Features</u>                      |                                | (T) |
|     | (1) <u>Supervisory Signaling</u>                            | FID                            |     |
|     | DX Supervisory Signaling<br>arrangement                     |                                |     |
|     | - Per Transmission Path* NCI                                | ++DX+                          |     |
|     | SF Supervisory Signaling<br>arrangement                     |                                |     |
|     | - Per Transmission Path** NCI                               | ++SF+                          |     |
|     | E&M Type 1 Supervisory<br>Signaling arrangement             |                                |     |
|     | - Per Transmission Path* NCI                                | ++EA+                          |     |
|     | E&M Type II Supervisory<br>Signaling arrangement            |                                |     |
|     | - Per Transmission Path* NCI                                | ++EB+                          |     |
|     | E&M Type III Supervisory<br>Signaling                       |                                |     |
|     | - Per Transmission Path*** NCI                              | ++EC+                          |     |
|     | Tandem, Supervisory<br>Signaling                            |                                |     |
|     | - Per Transmission Path — NCI                               | ++EX+                          |     |

PUBLIC SERVICE COMMISSION  
OF KENTUCKY  
EFFECTIVE

MAY 23 1995

PURSUANT TO 807 KAR 5011.

SECTION 9(1)  
BY: *Don C. Neal*  
FOR THE PUBLIC SERVICE COMMISSION

† Applies to FGD.

\* Available with Interface Groups 1 and 2.

\*\* Available with Interface Groups 2, 6 and 9.

\*\*\* Available with Interface Groups 1 and 2 for FGD.

\*\*\*\* Available with Interface Group 2 for FGA.

Issued: June 13, 1995

Effective: May 23, 1995

*Deborah L. Nisch*  
Vice President

President, Cincinnati, Ohio

Integrated Corporate Planning for

ACCESS SERVICE TARIFF  
PSCK No. 2

CINCINNATI BELL TELEPHONE COMPANY

2nd Revised Page 262  
Cancels 1st Revised Page 262

6. Switched Access Service (Cont'd)

6.8 Rates and Charges (Cont'd)

6.8.2 Switched Transport (Cont'd)

(C) Nonchargeable Optional Features (Cont'd)

- (2) Customer specification of the receive transmission level at the first point of switching within a range acceptable to the Telephone Company  
- Per Transmission Path\*

FID

TLV

- (3) Customer specification of Switched Transport Termination  
Four-wire termination in lieu of two-wire termination  
- Per Transmission Path\*\*

NC S+T+

(H) Service Rearrangement Charge

- (1) CCSAC Trunk Conversion  
- per first trunk converted per trunk group.  
- per additional trunk converted which is part of the same trunk group.

USOC

Nonrecurring Charge

NRBOA

NONE

NRBOB

NONE

PUBLIC SERVICE COMMISSION  
OF KENTUCKY  
EFFECTIVE

MAY 23 1995

PURSUANT TO 807 KAR 5:011,  
SECTION 9(1)

BY: Jordan C. Neal  
FOR THE PUBLIC SERVICE COMMISSION

- \* Available with Interface Groups 2, 6 and 10 for FGA and FGB. The range of transmission levels which may be specified is described in Technical Reference TR-NPL-000334. (C)  
\*\* Available with Feature Group B with type B Transmission Performance.  
\*\*\* Available with Interface Groups 6 and 9 for Feature Group D. (C)

Issued: June 13, 1995

Effective: May 23, 1995

*Deborah A. Nisch* President, Cincinnati, Ohio  
Vice President  
Integrated Corporate Planning for

ACCESS SERVICE TARIFF  
PSC No. 2

CINCINNATI BELL TELEPHONE COMPANY

1st Revised Page 262.1  
Cancels Original Page 262.1

6. Switched Access Service (Cont'd)

6.8 Rates and Charges

6.8.2 Switched Transport (Cont'd)

(I) CCSAC Signaling Link and STP Port Termination Charges

|                         | <u>USOC</u> | <u>Monthly Rate</u> | <u>Nonrecurring Charge</u> |                            |
|-------------------------|-------------|---------------------|----------------------------|----------------------------|
|                         |             |                     |                            | (M)                        |
|                         |             |                     |                            |                            |
|                         |             |                     |                            | (M)                        |
| 1) CCSAC Signaling Link |             |                     |                            | (T)                        |
| a) Channel Termination* |             |                     |                            |                            |
| - per DS1 link          |             | 135.79              | NONE                       |                            |
| - per 56 Kbps link      | TNTFX       | 70.00(R)            | NONE                       |                            |
|                         | <u>USOC</u> | <u>Fixed</u>        | <u>Per Mile</u>            | <u>Nonrecurring Charge</u> |
| b) Channel Mileage**    |             |                     |                            |                            |
| - per DS1 link          |             |                     |                            |                            |
| <u>Mileage Band</u>     |             |                     |                            |                            |
| Over 0                  |             | NONE<br>\$113.37(R) | NONE<br>\$12.50(R)         | NONE<br>NONE               |
| - per 56 Kbps link      |             |                     |                            |                            |
| <u>Mileage Band</u>     |             |                     |                            |                            |
| 0                       | 1J5FS       | NONE                | NONE                       | NONE                       |
| Over 0                  | 1J5FS       | 61.00(I)            | 1.04(I)                    | NONE                       |

\*One Channel Termination applies per CCSAC Signaling Link.

\*\*Channel Mileage applies between Serving Wire Center and STP, but does not apply when mileage is zero.

Filed in accordance with Case No. 98-292, Order issued July 26, 1999.

Certain regulations previously appearing on this page now appear on page 263.

(T)

Issued: September 22, 1999

Effective: January 25, 1999

President, Cincinnati, Ohio

ACCESS SERVICE TARIFF  
PSC No. 2

CINCINNATI BELL TELEPHONE COMPANY

4th Revised Page 263  
Cancels 3rd Revised Page 263

6. Switched Access Service (Cont'd)

6.8 Rates and Charges (Cont'd)

6.8.3 Local Switching

(A) Usage Sensitive Rates

|     |   | Rate<br><u>Per Access Minute</u>                     |   |
|-----|---|--|---|
| (1) | Premium Rates                           |  |   |
|     | LS1                                     | \$0,005404 (R)                                       |   |
|     | (A) Common Trunk Port<br>Per Port       | 0.000978   | (N)                                       |
|     | (B) Dedicated Trunk Port                | <u>Monthly Rate</u><br>\$ 6.17                       | (N)                                       |
| (2) | 800 Access Service                      | <u>Rate<br/>Per Query</u>                            |   |
|     | Data Base Query Charge<br>per query     | \$0.0024   |   |
|     | Routing Options Capability<br>per query | \$0.0002   |   |
| (3) | STP Port Termination<br>per Port        | <u>USOC</u><br>PT8SX <u>Monthly Rate</u><br>\$889.75 | <u>Nonrecurring Charge</u><br>NONE<br>(M) |

Filed in accordance with Case No. 98-292. Order issued July 26, 1999.  
Certain Regulations on this page previously appeared on Page 262.1

Issued: September 22, 1999  
1999

Effective: January 25.

President, Cincinnati, Ohio

ACCESS SERVICE TARIFF  
PSC No. 2

CINCINNATI BELL TELEPHONE COMPANY

Original Page 264

6. Switched Access Service (Cont'd)

6.8 Rates and Charges (Cont'd)

6.8.3 Local Switching (Cont'd)

(B) Common Switching Nonchargeable Optional Features

|  | <u>FID</u>  |
|--|---|
| Call Denial on Line or Hunt Group (available with FGA)<br>- Per Transmission Path or Transmission Path Group                                   | CAD   |
| Service Code Denial on Line or Hunt Group (available with FGA)<br>- Per Transmission Path or Transmission Path Group                           | SCD   |
| 900/700/976 Call Blocking on Line or Hunt Group (available with FGA)<br>- Per Transmission Path or Transmission Path Group                     | CBK   |
| Hunt Group Arrangement (available with FGA)<br>- Per Transmission Path Group   | HML/HTG   |
| Uniform Call Distribution Arrangement (available with FGA)<br>- Per Transmission Path Group  | PUBLIC SERVICE COMMISSION<br>OF KENTUCKY<br>EFFECTIVE   |
| Nonhunting Number for Use with Hunt Group Arrangement or Uniform Call Distribution Arrangement (available with FGA)<br>- Per Transmission Path | MAR 3 1992<br>PURSUANT TO 807 KAR 5:011,<br>SECTION 9 (1)<br>BY: <u>G. J. Miller</u><br>PUBLIC SERVICE COMMISSION MANAGER |

Issued: February 7, 1992

Effective: March 3, 1992

*Robert E. Aigmon* for President, Cincinnati, Ohio

Vice President - Regulatory Affairs



ACCESS SERVICE TARIFF  
PSCK No. 2

CINCINNATI BELL TELEPHONE COMPANY

2nd Revised Page 265  
Cancels 1st Revised Page 265

6. Switched Access Service (Cont'd)

6.8 Rates and Charges (Cont'd)

6.8.3 Local Switching (Cont'd)

(B) Common Switching Nonchargeable Optional Features (Cont'd)

|   | FID         |                 |
|---|-------------|-----------------|
| Automatic Number Identification (available with FGB and FGD)<br>Per Transmission Path Group                 | AN ■        |                 |
| Expanded ANI digits (52) for WATS. (Available with FGD in conjunction with Automatic Name Identification)   | FAN ■       | (C)<br> <br>(C) |
| Up to 7 Digit Outpulsing of Access Digits to Customer (available with FGB)<br>- Per Transmission Path Group | USDO        |                 |
| Cut-Through (available with FGD)<br>- Per End Office or Access Tandem                                       | CTO         |                 |
|   | <u>USOC</u> |                 |
| Calling Party Number<br>- Per End Office per Trunk Group  | NR4CP       |                 |
| Charge Number<br>- Per End Office per Trunk Group   | NR4CN       |                 |

Filed in accordance with Case No. 98-292. Order issued July 26, 1999.

Issued: September 22, 1999

Effective: January 25, 1999

President, Cincinnati, Ohio

ACCESS SERVICE TARIFF  
PSC No. 2

CINCINNATI BELL TELEPHONE COMPANY

1st Revised Page 266  
Cancels Original Page 266

6. Switched Access Service (Cont'd)

6.8 Rates and Charges (Cont'd)

6.8.3 Local Switching (Cont'd)

(B) Common Switching Nonchargeable Optional Features (Cont'd)

FID

Service Class Routing  
(available with FGD  
- Per Transmission Path  
Group

SCRT

USOC

(N)

Carrier Selection Parameter  
- Per End Office per  
Trunk Group

NR4CS

(N)

PUBLIC SERVICE COMMISSION  
OF KENTUCKY  
EFFECTIVE

OCT 26 1992

PURSUANT TO 807 KAR 5:011,  
SECTION 9(1)

Issued: September 24, 1992

Effective: October 26, 1992

BY: [Signature]  
PUBLIC SERVICE COMMISSION MANAGER

Robert E. Aignone for President, Cincinnati, Ohio

Vice President - Regulatory Affairs

ACCESS SERVICE TARIFF  
PSCK No. 2

CINCINNATI BELL TELEPHONE COMPANY

Original Page 267

6. Switched Access Service (Cont'd)

6.8 Rates and Charges (Cont'd)

6.8.3 Local Switching (Cont'd)

(B) Common Switching Nonchargeable Optional Features (Cont'd)

|  | <u>FID</u> |
|--|------------|
| Alternate Traffic Routing  | ARTG       |
| ▪ Multiple Customer Premises Alternate Routing (available with FGB and FGD)        |            |
| - Per Transmission Path or Transmission Path Group                                 |            |
| ▪ End Office Alternate Routing When Ordered in Trunks (available with FGB and FGD) |            |
| - Per Transmission Path or Transmission Path Group                                 |            |

|   |      |
|---|------|
| International Carrier Option (available with FGD) |      |
| - Per End Office and Access Tandem                | INCO |

|  |  |
|--|--|
| Band Advance Arrangement for Use with WATS Access Line Service (available with FGA, FGB and FGD) |  |
| - Per Arrangement  |  |

PUBLIC SERVICE COMMISSION  
OF KENTUCKY  
EFFECTIVE

MAR 3 1992

PURSUANT TO 807 KAR 5:011,  
SECTION 9 (1)

BY: Charles J. Miller  
PUBLIC SERVICE COMMISSION MANAGER

Issued: February 7, 1992

Effective: March 3, 1992

Robert E. Aigmon FOR President, Cincinnati, Ohio

Vice President - Regulatory Affairs

ACCESS SERVICE TARIFF  
PSCK No. 2

CINCINNATI BELL TELEPHONE COMPANY

Original Page 268

6. Switched Access Service (Cont'd)

6.8 Rates and Charges (Cont'd)

6.8.3 Local Switching (Cont'd)

(B) ~~Common Switching Nonchargeable Optional Features~~ (Cont'd)

|   | <u>FID</u>   |
|---|--|
| End Office End User<br>Line Service Screening<br>for Use with WATS<br>Access Line Service<br>(available with FGD)<br>- Per Access Line  | BAND   |
| Hunt Group Arrangement<br>for Use with WATS<br>Access Line Service<br>(available with FGA, FGB<br>and FGD)<br>- Per Access Line<br>Group  | HML/IITG   |
| Uniform Call Distribution<br>Arrangement for Use with<br>WATS Access Line Service<br>(available with FGA,<br>FGB and FGD)<br>- Per Access Line<br>Group   | HIY UD   |
| Nonhunting Number for<br>Use with Hunt Group<br>Arrangement or Uniform<br>Call Distribution<br>Arrangement for Use<br>with WATS Access<br>Line Service<br>(available with FGA, FGB<br>and FGD)<br>- Per Access Line | PUBLIC SERVICE COMMISSION<br>OF KENTUCKY<br>EFFECTIVE<br>NHN<br>MAR 3 1992   |
| Feature <b>Group D</b> with 950<br>Access (available with FGD)<br>- Per End Office  | PURSUANT TO 807 KAR 5:011,<br>SECTION 9 (1)<br>FGD9<br>BY: <u>Sharon Keller</u><br>PUBLIC SERVICE COMMISSION MANAGER |

Issued: February 7, 1992

Effective: March 3, 1992

*Robert E. Aigmon* for President, Cincinnati, Ohio

Vice President - Regulatory Affairs

ACCESS SERVICE TARIFF  
PSCK No. 2

CINCINNATI BELL TELEPHONE COMPANY

Original Page 269

6. Switched Access Service (Cont'd)

6.8 Rates and Charges (Cont'd)

6.8.3 Local Switching (Cont'd)

(C) Transport Termination Nonchargeable Options (Cont'd)

(1) Line Side Terminations (For FGA)

FID

Two Way Operation

- Dial Pulse with Loop Start NC +++A
- Dial Pulse with Ground Start NC +++E
- DTMF with Loop Start NC +++F
- DTMF with Ground Start NC +++G

Terminating Operation

- Dial Pulse with Loop Start NC +++N
- Dial Pulse with Ground Start NC +++P
- DTMF with Loop Start **NC +++R**
- DTMF with Ground Start NC +++S

Originating Operation

- Loop Start NC +++U
- Ground Start NC +++V

**PUBLIC SERVICE COMMISSION  
OF KENTUCKY  
EFFECTIVE**

MAR 3 1992

**PURSUANT TO 807 KAR 5:011,  
SECTION 9(1)**

BY: Sharon Keller  
PUBLIC SERVICE COMMISSION MANAGER

Issued: February 7, 1992

Effective: March 3, 1992

Robert E. Aigmon for President, Cincinnati, Ohio

Vice President - Regulatory Affairs

ACCESS SERVICE TARIFF  
PSCK No. 2

CINCINNATI BELL TELEPHONE COMPANY

Original Page 270

6. Switched Access Service (Cont'd)

6.8 Rates and Charges (Cont'd)

6.8.3 Local Switching (Cont'd)

(C) Transport Termination Nonchargeable Options (Cont'd)

(2) Trunk Side Terminations (For FGB and FGD)

|   | <u>FID</u>                 |
|---|----------------------------|
| Standard Trunk<br>for Originating,<br>Terminating or Two-<br>Way Operation<br>(available with FGB<br>and FGD) | TTC SO<br>TTC ST<br>TTC TY |
| Rotary Dial Station<br>Signaling Trunk<br>(available with FGB)  | TTC RD                     |
| Operator Trunk, Full<br>Feature Arrangement<br>(available with FGD)   | TTC FF                     |

**PUBUC SERVICE COMMISSION  
OF KENTUCKY  
EFFECTIVE**

MAR 3 1992

PURSUANT TO 807 KAR 5:011,  
SECTION 9 (1)

BY: Sharon Stiller  
PUBLIC SERVICE COMMISSION MANAGER

Issued: February 7, 1992  
*Robert E. Aigmon* for  
President, Cincinnati, Ohio

Effective: March 3, 1992

Vice president - **Regulatory Affairs**

ACCESS SERVICE TARIFF  
PSCK No. 2

CINCINNATI BELL TELEPHONE COMPANY

Original Page 271

6. Switched Access Service (Cont'd)

6.8 Rates and Charges (Cont'd)

6.8.3 Local Switching (Cont'd)

(D) WATS Access Line Termination Optional Features

(1) Line Side Connections

FID

Two-Wire Originating Only

- Loop Start/DP NC ++AN
- Loop Start/DTMF NC ++AR
- Ground Start/DP NC ++AP
- Ground Start/DTMF NC ++AS

Two-Wire Terminating Only

- Loop Start NC ++AU
- Ground Start NC ++AV

Two-Wire Two Way

- Loop Start/DP NC ++AA
- Loop Start/DTMF NC ++AF
- Ground Start/DP NC ++AE
- Ground Start/DTMF NC ++AG

**PUBLIC SERVICE COMMISSION  
OF KENTUCKY  
EFFECTIVE**

MAR 3 1992

**PURSUANT TO 807 KAR 5:011,  
SECTION 9 (1)**

BY: Shirley Staller  
PUBLIC SERVICE COMMISSION MANAGER

Issued: February 7, 1992

Effective: March 3, 1992

Robert E. Aignone for President, Cincinnati, Ohio

Vice President - Regulatory Affairs

ACCESS SERVICE TARIFF  
PSC No. 2

CINCINNATI BELL TELEPHONE COMPANY

1st Revised Page 272  
Cancels Original Page 272

6. Switched Access Service (Cont'd)

6.8 Rates and Charges (Cont'd)

6.8.3 Local Switching (Cont'd)

(D) WATS Access Line Termination Optional Features (Cont'd)

|  | (1) | Line Side Connections (Cont'd)   | FID     |          |
|--|-----|--|---------|----------|
|  |     | Four-Wire Originating Only   |         |          |
|  |     | - Loop Start/DP  | NC ++BN |          |
|  |     | - Loop Start/DTMF  | NC ++BR |          |
|  |     | - Ground Start/DP  | NC ++BP |          |
|  |     | - Ground Start/DTMF  | NC ++BS |          |
|  |     | Four-Wire Terminating Only   |         |          |
|  |     | - Loop Start   | NC ++BU |          |
|  |     | - Ground Start   | NC ++BV |          |
|  |     | Four-Wire Two Way  |         |          |
|  |     | - Loop Start/DP  | NC ++GA |          |
|  |     | - Loop Start/DTMF  | NC ++GF |          |
|  |     | - Ground Start/DP  | NC ++GE |          |
|  |     | - Ground Start/DTMF  | NC ++GG |          |
|  | (2) | <u>Trunk Side Connections</u>  |         |          |
|  |     | Two-Wire Terminating Only  |         |          |
|  |     | - DNIS (RV)  | NC ++AT |          |
|  |     | Four-Wire Terminating Only   |         |          |
|  |     | - DNIS (RV)  | NC ++BE |          |
|  |     | - DNIS (E&M)   | NC ++BT |          |
|  | (E) | Common Switching Optional Features   | USOC    | Rate     |
|  |     | Flexible Automatic Number Identification Information Digits (FLEX-ANI)<br>(available with FGD in conjunction with Automatic Number Identification) |         |          |
|  |     | - Per Carrier Identification Code (CIC)<br>Per End Office  | CF3FC   | \$916.59 |
|  |     |  |         | (N)      |

6.8.4 Reserved

6.8.5 Reserved

Filed in accordance with Case No. 98-292, Order issued July 26, 1999

Issued: September 22, 1999

President, Cincinnati, Ohio

Effective: January 25, 1999



ACCESS SERVICE TARIFF  
PSCK No. 2

CINCINNATI BELL TELEPHONE COMPANY

Original Page 273

6. Switched Access Service (Cont'd)

6.8 Rates and Charges (Cont'd)

6.8.6 Message Unit Credit

|                       | <u>Rate</u> |
|-----------------------|-------------|
| Message Unit Credit   |             |
| - Per Originating FGA |             |
| Access Minute         | \$0.0002    |

PUBLIC SERVICE COMMISSION  
OF KENTUCKY  
EFFECTIVE

MAR 3 1992

PURSUANT TO 807 KAR 5:011,  
SECTION 9 (1)

BY: Glenn Sallee  
PUBLIC SERVICE COMMISSION MANAGER

Issued: February 7, 1992

Effective: March 3, 1992

*Robert E. Aigmon* for President, Cincinnati, Ohio

Vice President - Regulatory Affairs

ACCESS SERVICE TARIFF  
PSC No. 2

CINCINNATI BELL TELEPHONE COMPANY

4th Revised Page 274  
Cancels 3rd Revised Page 274

6. Switched Access Service (Cont'd)

6.8 Rates and Charges (Cont'd)

6.8.7 Reserved (D)

6.8.8 Information Surcharge (D)

Rates

Premium, Per 100 Access Minutes \$ 0.026598 (R)

6.8.9 Reserved (D)

Filed in accordance with Case No. 98-292, Order issued July 26, 1999.

Issued: September 22, 1999

Effective: January 25, 1999

President, Cincinnati, Ohio

ACCESS SERVICE TARIFF  
PSC No. 2

CINCINNATI BELL TELEPHONE COMPANY

3rd Revised Page  
275  
Cancels 2nd Revised Page 275

6. Switched Access Service (Cont'd)  
6.8 Rates and Charges (Cont'd)  
6.8.10 900 Access Service

|  | <u>USOC</u> | <u>Nonrecurring<br/>Charge</u> |
|--|-------------|--------------------------------|
| Additions or deletions of 900<br>Access Service NXX codes routed<br>to a customer                                |             |                                |
| - Per Telephone Company End Office<br>Switch or Access Tandem in which<br>translation changes are required       |             |                                |
| - Assembly of rate and route<br>pattern (applies only on initial<br>request for 900 Access Service<br>in a LATA) | N9E         | \$156.01(I)                    |
| - Activation or deactivation of<br>first 900 Access Service NXX<br>code contained in a request                   | N9GIX       | 25.09(R)                       |
| - Activation or deactivation of each<br>additional 900 Access Service NXX<br>code contained in the same request  | N9GAX       | 10.04 (R)                      |

Filed in accordance with Case No. 98-292, Order issued July 26, 1999

Issued: September 22, 1999

Effective: January 25, 1999

President, Cincinnati, Ohio

ACCESS SERVICE TARIFF  
PSC No. 2

CINCINNATI BELL TELEPHONE COMPANY

Original Page 275.1

6. Switched Access Service (Cont'd)

6.8 Rates and Charges (Cont'd)

6.8.11 500 Access Service

Additions or deletions of 500  
Access Service NXX codes routed  
to a customer

- Per Telephone Company End Office  
Switch or Access Tandem in which  
translation changes are required

- Assembly of rate and route  
pattern in a LATA (applies  
for initial establishment of  
500 service, or if 0+500 is  
added or deleted after initial  
service activation)

- Activation or deactivation of  
first 500 Access Service NXX  
code contained in a request or  
activate or deactivate 0+500  
dialing capability to existing  
1+500 service

- Activation or deactivation of  
each additional 500 Access Service  
NXX code contained in the same  
request or activate or deactivate  
0+500 dialing capability to  
existing 1+500 service

| USOC | Nonrecurring<br>Charge |
|------|------------------------|
|------|------------------------|

|  |          |
|--|----------|
|  | \$156.01 |
|--|----------|

|  |       |
|--|-------|
|  | 25.09 |
|--|-------|

|  |       |
|--|-------|
|  | 10.04 |
|--|-------|

(N)

(N)

Filed in accordance with Case No. 98-292. Order issued July 26, 1999.

Issued: September 22, 1999

Effective: January 25, 1999

President, Cincinnati, Ohio

ACCESS SERVICE TARIFF  
PSC No. 2

CINCINNATI BELL TELEPHONE COMPANY

Original Page 276

7. Special Access Service

7.1 General

Special Access Service with the exception of the WATS Access Line and Customer Network Reconfiguration Service, provides a transmission path to connect customer designated premises\*, either directly or through a Telephone Company Hub where bridging, multiplexing or Customer Network Reconfiguration Service functions are performed. The WATS Access Line, offered under Voice Grade Service, provides a transmission path connecting a customer designated premises with a WATS serving office. Customer Network Reconfiguration Service, provides customers with the ability to reconfigure their Special Access circuits. Special Access Service includes all exchange access not utilizing Telephone Company end office switches.

The connections provided by Special Access Service can be either analog or digital. Analog connections are differentiated by spectrum and bandwidth. Digital connections are differentiated by bit rate.

7.1.1 Channel Types

There are seven types of channels used to provide Special Access Services. Each type has its own characteristics. All are subdivided by one or more of the following:

- Transmission specifications,
- Bandwidth,
- Speed (i.e., bit rate,)
- Spectrum

Customers can order a basic channel and select from a list of available transmission parameters and channel interfaces those that they desire to meet specific communications requirements.

\* Telephone Company Centrex CO-like switches, Telephone Company Answering Service Concentrators and packet switches included in Public Packet Switched Network (PPSN) Service are considered to be customer premises for purposes of administering regulations and rates contained in this tariff.

PUBLIC SERVICE COMMISSION

OF KENTUCKY

EFFECTIVE

MAR 3 1992

PURSUANT TO 807 KAR 5:011,  
SECTION 9(1)

Issued: February 7, 1992

Effective: *Cham Bell*  
BY: *Cham Bell*  
PUBLIC SERVICE COMMISSION MANAGER

*Robert E. Aigun* FOR President, Cincinnati, Ohio

Vice President - Regulatory Affairs

ACCESS SERVICE TARIFF  
PSC No. 2

CINCINNATI BELL TELEPHONE COMPANY

Original Page 277

7. Special Access Service (Cont'd)

7.1 General (Cont'd)

7.1.1 Channel Types (Cont'd)

For purposes of ordering channels, each has been identified as a type of Special Access Service. However, such identification is not intended to limit a customer's use of the channel nor to imply that the channel is limited to a particular use. For example, if a customer's equipment is capable of transmitting voice over a channel that is identified as a Metallic Service in this tariff, there is no restriction against doing so.

Following is a brief description of each type of channel:

Metallic - a channel for the transmission of low speed varying signals at rates up to **30** baud.

Telegraph Grade - a channel for the transmission of binary signals at rates of **0** to 75 baud or **0** to 150 baud.

Voice Grade - a channel for the transmission of analog signals within an approximate bandwidth of 300 to **3000** Hz. This may also include channels for use for **800** Service, WATS, or similar services.

Program Audio - a channel for the transmission of audio signals. The nominal frequency bandwidths are from 50 to 15000 Hz, from **200** to 3500 Hz, from 100 to **5000** Hz or from 50 to **8000** Hz.

PUBLIC SERVICE COMMISSION  
OF KENTUCKY  
EFFECTIVE

MAR 3 1992

PURSUANT TO 807 KAR 5:011,

BY: *Shirley L. Miller*

Effective March 3, 1992

Issued: February 7, 1992

*Robert E. Aigmon* for President, Cincinnati, Ohio

Vice President - Regulatory Affairs

7. Special Access Service (Cont'd)

7.1 General (Cont'd)

7.1.1 Channel Types (Cont'd)

Digital Data - a channel for the digital transmission of synchronous serial data at rates of 2.4, 4.8, 9.6, 19.2 56 or 64 kpbs. (C)

High Capacity - a channel for the transmission of isochronous serial digital data at rates of 1.544, 3.152, 6.312, 44.736 or 274.176 Mbps.

Detailed descriptions of each of the channel types are provided in 7.2 following.

The customer also has the option of ordering Voice Grade and digital high capacity facilities (i.e., 1.544 Mbps, 3.152 Mbps, 6.312 Mbps, 44.736 Mbps and 274.176 Mbps) to a Telephone Company hub for multiplexing to individual channels of a lower capacity or bandwidth. Descriptions of the types of multiplexing available at the hubs, as well as the number of individual channels which may be derived from each type of facility are set forth in 7.2 following. Additionally, the customer may specify optional features for the individual channels derived from the facility to further tailor the channel to meet specific communications requirements. Descriptions of the optional features and functions available are also set forth in 7.2 following.

7. Special Access Service (Cont'd)

7.1 General (Cont'd)

7.1.1 Channel Types (Cont'd)

For example, a customer may order a 3.152 Mbps facility from a customer designated premises to a Telephone Company hub for multiplexing to two 1.544 Mbps channels. The 1.544 Mbps channels may be further multiplexed at the same or a different hub to Voice Grade or Digital Data (i.e., 2.4, 4.8, 9.6, 19.2, 56 or 64 kbps) channels or may be extended to other customer designated premises. Optional features may be added to either the 1.544 Mbps or the Voice Grade channels. (C)

7.1.2 Rate Categories

There are three basic rate categories which apply to Special Access Service:

- Channel Terminations (described in 7.1.2(A) following)
- Channel Mileage (described in 7.1.2(B) following)
- Optional Features and Functions (described in 7.1.2(C) following)



ACCESS SERVICE TARIFF  
PSCK No. 2

CINCINNATI BELL TELEPHONE COMPANY

Original Page 280

7. Special Access Service (Cont'd)

7.1 General (Cont'd)

7.1.2 Rate Categories (Cont'd)

(A) Channel Termination

The Channel Termination rate category provides for the communications path between a customer designated premises and the serving wire center of that premises. Included as part of the Channel Termination is a standard channel interface arrangement which defines the technical characteristics associated with the type of facilities to which the access service is to be connected at the Point of Termination (POT) and the type of signaling capability, if any. The signaling capability itself is provided as an optional feature as set forth in (C) following. One Channel Termination charge applies per customer designated premises at which the channel is terminated. This charge will apply even if the customer designated premises and the serving wire center are co-located in a Telephone Company building.

PUBLIC SERVICE COMMISSION  
OF KENTUCKY  
EFFECTIVE

MAR 3 1992

PURSUANT TO 807 KAR 5:011,  
SECTION 9 (1)

BY:   
PUBLIC SERVICE COMMISSION MANAGER

Issued: February 7, 1992

Effective: March 3, 1992

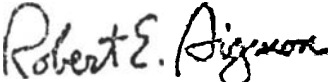
 for President, Cincinnati, Ohio

Vice President - Regulatory Affairs

ACCESS SERVICE TARIFF  
PSCK No. 2

CINCINNATI BELL TELEPHONE COMPANY

Original Page 281

7. Special Access Service (Cont'd)

7.1 General (Cont'd)

7.1.2 Rate Categories (Cont'd)

(B) Channel Mileage

The Channel Mileage rate category provides for the transmission facilities between the serving wire centers associated with two customer designated premises, between a serving wire center associated with a customer designed premises and a Telephone Company hub or between two Telephone Company hubs. Channel Mileage is portrayed in mileage bands. There are two rates that apply for each band, i.e., a flat rate per band and a rate per mile.

(C) Optional Features and Functions

The Optional Features and Functions rate category provides for optional features and functions which may be added to a Special Access Service to improve its quality or utility to meet specific communications requirements. These are not necessarily identifiable with specific equipment, but rather represent the end result in terms of performance characteristics which may be obtained. These characteristics may be obtained by using various combinations of equipment. Although the equipment necessary to perform a specified function may be installed at various locations along the path of the service, they will be charged for as a single rate element.

**PUBLIC SERVICE COMMISSION  
OF KENTUCKY  
EFFECTIVE**

MAR 3 1992

**PURSUANT TO §07 KAR 5:011,  
SECTION 9 (1)**

BY: Sharon Deller  
PUBLIC SERVICE COMMISSION MANAGER

Issued: February 7, 1992

Effective: March 3, 1992

Robert E. Aigmon for President, Cincinnati, Ohio

**Vice President - Regulatory Affairs**

ACCESS SERVICE TARIFF  
PSCK No. 2

CINCINNATI BELL TELEPHONE COMPANY

Original Page 282

7. Special Access Service (Cont'd)

7.1 General (Cont'd)

7.1.2 Rate Categories (Cont'd)

(C) Optional Features and Functions (Cont'd)

Examples of Optional Features and Functions that are available include, but are not limited to, the following:

- Signaling Capability
- Hubbing Functions
- Conditioning
- Transfer Arrangements

A hub is a Telephone Company designated serving wire center at which bridging, multiplexing or Customer Network Reconfiguration Service functions are performed. The bridging functions performed are to connect three or more customer designated premises in a multipoint arrangement. The multiplexing functions are to channelize analog or digital facilities to individual services requiring a lower capacity or bandwidth. The Customer Network Reconfiguration Service functions allow customers to reconfigure their Special Access Services. National Exchange Carrier Association, Inc. Tariff FCC No. 4 identifies serving wire centers, hub locations and the type of bridging, multiplexing or Customer Network Reconfiguration Service functions available.

Descriptions for each of the available Optional Features and Functions are set forth in 7.2 following.

7.1.3 Service Configurations

There are two types of service configurations over which Special Access Services are provided: two-point service and multipoint service.

(A) Do-Point Service

A two-point service connects two customer designated premises, or a customer designated premises and a serving office for Voice Grade WATS Access Line Service, either on a directly connected basis or through a hub where multiplexing functions are performed. In addition, a two point service may connect a customer designated premises and a Customer Network Reconfiguration Service hub.

PUBLIC SERVICE COMMISSION  
OF KENTUCKY

Effective: *Sharon Butler*  
MAY 8 1992  
PUBLIC SERVICE COMMISSION MANAGER

Issued: February 7, 1992

*Robert E. Aigmon*

for

President, Cincinnati, Ohio

Vice President - Regulatory Affairs

ACCESS SERVICE TARIFF  
PSCK No. 2

CINCINNATI BELL TELEPHONE COMPANY

1st Revised Page 283  
Cancels Original Page 283

7. Special Access Service (Cont'd)

7.1 General (Cont'd)

7.1.3 Service Configurations (Cont'd)

(A) Two-Point Service (Cont'd)

Applicable rate elements are:

- Channel Terminations\*
- Channel Mileage (as applicable)
- Optional Features and Functions (when applicable)

In addition, a Special Access Surcharge, as set forth in 7.4.2 following, may be applicable.

- (1) The following diagram depicts a two-point Voice Grade service connecting two customer designated premises located 15 miles apart. The service is provided with C-Type conditioning.

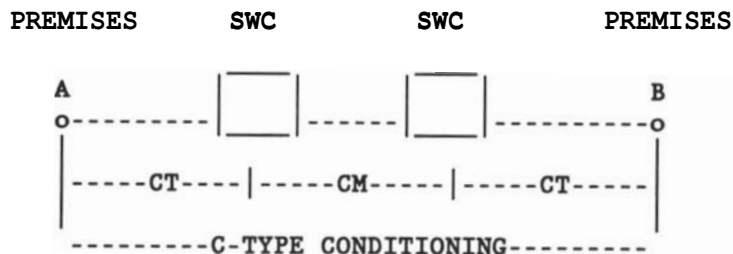

CT - Channel Termination  
CM - Channel Mileage  
SWC - Serving Wire Center

Applicable rate elements are:

- Channel Terminations (2 applicable)
- Channel Mileage (mileage band Over 8 to 25 miles)
- C-Type Conditioning Optional Feature

\*Only one Channel Termination will apply for Voice Grade WATS Access Line Service, (see diagram on Page 109.6.1).

(C)  
(C)

Issued: June 13, 1995

Effective: May 23, 1995

*Deborah A. Nisch*  
Vice President  
Integrated Corporate Planning for

President, Cincinnati, Ohio

PUBLIC SERVICE COMMISSION  
OF KENTUCKY  
EFFECTIVE

MAY 23 1995

PURSUANT TO 807 KAR 5.011,  
SECTION 9(1)

BY: *Jordan C. Neal*  
FOR THE PUBLIC SERVICE COMMISSION

ACCESS SERVICE TARIFF  
PSCK No. 2

CINCINNATI BELL TELEPHONE COMPANY

Original Page 284

7. Special Access Service (Cont'd)

7.1 General (Cont'd)

7.1.3 Service Configurations (Cont'd)

(A) Two-Point Service (Cont'd)

- (2) The following diagram depicts a Voice Grade WATS Access Line Service where the WATS Serving Office is 10 miles from the serving wire center of the customer designated premises.

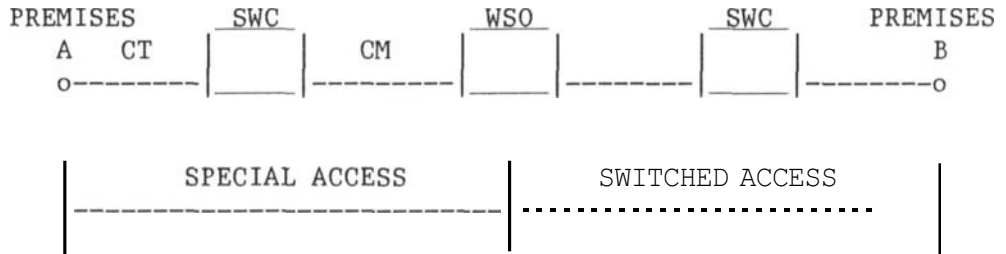

CT - Channel Termination  
CM - Channel Mileage  
SWC - Serving Wire Center  
WSO - WATS Serving Office

Applicable rate elements are:

- Channel Termination (one applicable)
- Channel Mileage (mileage band **9-25**)
- Switched Access rates (see Section 6)

PUBLIC SERVICE COMMISSION  
OF KENTUCKY  
EFFECTIVE

MAR 3 1992

PURSUANT TO 807 KAR 5:011,

Issued: February 7, 1992

Effective: <sup>SECTION 9(1)</sup> March 3, 1992

*Robert E. Aigmon* for President, Cincinnati, Ohio

BY: *Cheryl L. ...*  
PUBLIC SERVICE COMMISSION MANAGER

Vice President - Regulatory Affairs

ACCESS SERVICE TARIFF  
PSC No. 2

CINCINNATI BELL TELEPHONE COMPANY

Original Page 285

7. Special Access Service (Cont'd)

7.1 General (Cont'd)

7.1.3 Service Configurations (Cont'd)

(B) Multipoint Service (Cont'd)

Multipoint service connects three or more customer designated premises through a Telephone Company hub. Only certain types of Special Access Service are provided as multipoint service. These are **so** designated in the Service Descriptions set forth in 7.2 following.

The channel between hubs (i.e., bridging locations) on a multipoint service is a mid-link. There is no limitation on the number of mid-links available with a multipoint service. However, when more than three mid-links in tandem are provided the quality of the overall service may be degraded.

Multipoint service utilizing a customized technical specifications package, as set forth in 7.2 following, will be provided when technically possible. If the Telephone Company determines that the requested characteristics for a multipoint service are not compatible, the customer will be advised and given the opportunity to change the order.

When ordering, the customer will specify the desired bridging hub(s). National Exchange Carrier Association Tariff FCC No. 4 identifies serving wire centers, hub locations and the type of bridging functions available.

Applicable Rate Elements are:

- Channel Terminations (one per customer designated premises)
- Channel Mileage (as applicable between each designated customer premises and the hub and between hubs).
- Bridging
- Additional Optional Features and Functions (when applicable).

In addition, the Special Access Surcharge, as set forth in 7.4.2 following, may be applicable.

PUBLIC SERVICE COMMISSION  
OF KENTUCKY  
EFFECTIVE

MAR 3 1992

PURSUANT TO 807 KAR 5:011,

SECTION 9 (1)  
Effective: March 3, 1992  
BY: *George J. Miller*  
PUBLIC SERVICE COMMISSION MANAGER

Approved: February 7, 1992  
*Robert E. Aigmon* for President, Cincinnati, Ohio

Vice President - Regulatory Affairs

7. Special Access Service (Cont'd)

7.1 General (Cont'd)

7.1.3 Service Configurations (Cont'd)

(B) Multipoint Service (Cont'd)

Example: Voice Grade multipoint service connecting four customer premises via two customer specified bridging hubs.

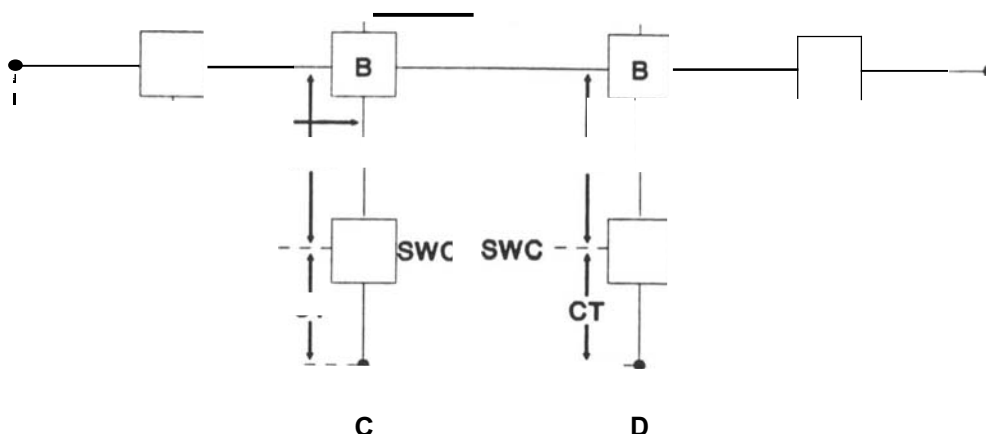

CT - Channel Termination  
CM - Channel Mileage  
B - Bridging  
SWC - Serving Wire Center

Applicable rate elements are:

- Channel Terminations (4 applicable)
- Channel Mileage (5 sections, each from appropriate mileage band)
- Bridging Optional Feature (6 applicable, i.e., each bridge port)

PUBLIC SERVICE COMMISSION  
OF KENTUCKY  
EFFECTIVE

MAR 3 1992

PURSUANT TO 807 KAR 5:011.

SECTION 9 (1)

Effective: March 3, 1992

BY: *[Signature]*  
PUBLIC SERVICE COMMISSION MANAGER

Issued: February 7, 1992

*Robert E. Aigmon* for President, Cincinnati, Ohio

Vice President - Regulatory Affairs

ACCESS SERVICE TARIFF  
PSC No. 2

CINCINNATI BELL TELEPHONE COMPANY

2nd Revised Page 287  
Cancels 1st Revised Page 287

7. Special Access Service (Cont'd)

7.1 General (Cont'd)

7.1.3 Service Configurations (Cont'd)

(C) Customer Network Reconfiguration Service (CNRS)

CNRS provides customer management capability of Voice Grade Service Channels, 9.6. 19.2. 56 and 64 Kbps Digital Data Service channels and MercNET 1.5 High Capacity Service Channels as specified in 7.2.10 following. CNRS is provided from CNRS hubs which are identified in the National Exchange Carrier Association, Inc. Tariff FCC No. 4. DS1 High Capacity Service facilities between CNRS hubs are referred to as CNRS mid links. Digital Data and Voice Grade Service channels are not available for use as CNRS mid links. (C)

Applicable rate elements with monthly rates are:

- DS0 and DS1 Port Charges
- Channel Termination Charges (One per customer designated premises)
- Channel Mileage Charges (as applicable between each designated customer premises and a CNRS hub and between CNRS hubs).

---

Issued: February 23, 1999

Effective: January 25, 1999

President, Cincinnati, Ohio



ACCESS SERVICE TARIFF  
 PSCK No. 2

CINCINNATI BELL TELEPHONE COMPANY

Original Page 288

7. Special Access Service (Cont'd)

7.1 General (Cont'd)

7.1.3 Service Configurations (Cont'd)

(C) Customer Network Reconfiguration Service (CNRS) (Cont'd)

Example: CNRS configuration utilizing one CNRS hub, four customer premises locations served by DS1 High Capacity channels and two customer premises locations served by 56 kbps Digital Data channels.

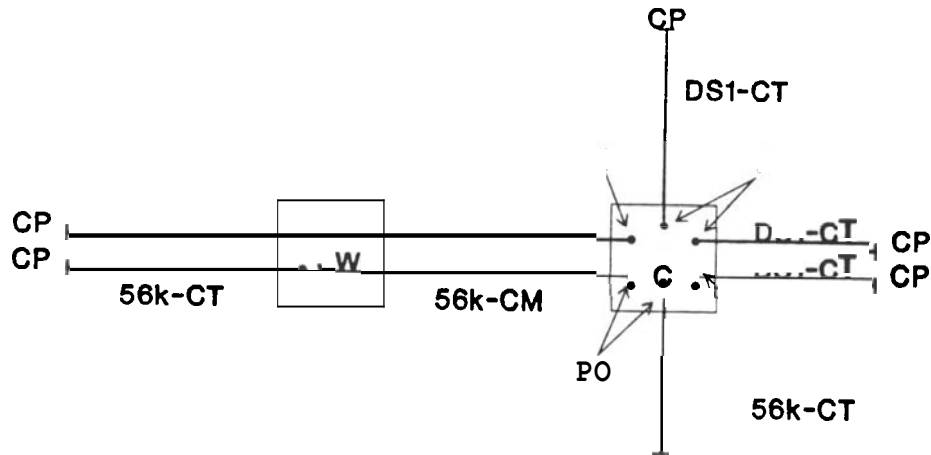

- CP - Customer Premises
- C - CNRS Hub
- SWC - Serving Wire Center
- DS1 - DS1 High Capacity Service
- CT - Channel Termination
- CM - Channel Mileage
- PO - CNRS DSO Port
- P1 - CNRS DS1 Port
- 56k - 56 kbps Digital Data Service

Rate elements with monthly rates are:

- Channel Termination (four DS1 and two 56 kbps DDS are applicable)
- Channel Mileage (one section of DS1 and one section of 56 kbps DDS are applicable)
- CNRS Port Charges (four DS1 and two DSO are applicable)

PUBLIC SERVICE COMMISSION  
 OF KENTUCKY  
 EFFECTIVE

DDSMAR 3 1992  
 PURSUANT TO 807 KAR 5:011,  
 SECTION 9(1)  
 BY: *[Signature]*

Issued: February 7, 1992

Effective: March 3, 1992

*Robert E. Aiguon* for President, Cincinnati, Ohio

Vice President - Regulatory Affairs

7. Special Access Service (Cont'd)

7.1 General (Cont'd)

7.1.3 Service Configurations (Cont'd)

(C) Customer Network Reconfiguration Service (CNRS) (Cont'd)

Example: CNRS configuration utilizing two CNRS hubs and four customer premises locations served by DS1 High Capacity channels and two customer premises locations served by 56 kbps Digital Data Channels

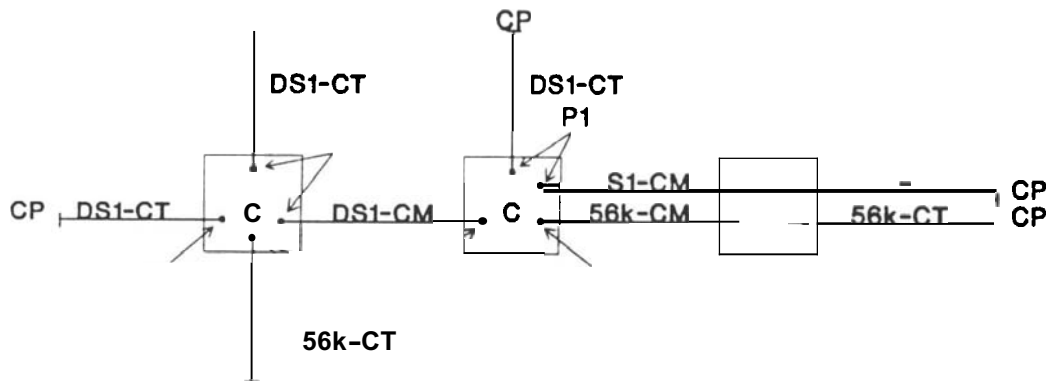

- CP - Customer Premises
- C - CNRS Hub
- SWC - Serving Wire Center
- DS1 - DS1 High Capacity Facility
- CT - Channel Termination
- CM - Channel Mileage
- PO - CNRS DSO Port
- P1 - CNRS DS1 Port
- 56k - 56 kbps Digital Data Services

Rate elements with monthly recurring rates are:

- Channel Termination (four DS1 and two 56 kbps Digital Data Services are applicable)
- Channel Mileage (two sections of DS1 and one section of 56 kbps Digital Data Services are applicable)
- CNRS Port Charges (three DS1 and one DSO terminations are applicable in hub on left and three DS1 and one DS1 termination are applicable in hub on right).

PUBLIC SERVICE COMMISSION  
 OF KENTUCKY  
 EFFECTIVE  
 1992  
 PURSUANT TO 807 KAR 5:011,  
 SECTION 9 (1)

Issued: February 7, 1992

Effective: March 2, 1992  
 PUBLIC SERVICE COMMISSION

*Robert E. Aigmon* for President, Cincinnati, Ohio

Vice President - Regulatory Affairs

ACCESS SERVICE TARIFF  
PSCK No. 2

CINCINNATI BELL TELEPHONE COMPANY

Original Page 290

7. Special Access Service (Cont'd)

7.1 General (Cont'd)

7.1.4 Alternate Use

Alternate Use occurs when a service is arranged by the Telephone Company **so** that the customer can select different types of transmission at different times. A customer may use a service in any privately beneficial manner. However, where technical or engineering changes are required to effectuate an alternate use, the Telephone Company will make such special arrangements available on an individual case basis.

The arrangement required to transfer the service from one operation to the other (i.e., the transfer relay and control leads) will be rated and provided on an individual case basis and filed in Section 12., Specialized Service or Arrangements. The customer will pay the stated tariff rates for the Access Service rate elements for the service ordered (i.e., Channel Terminations, Channel Mileage [as applicable] and Optional Features and Functions [if any]).

7.1.5 Special Facilities Routing

A customer may request that the facilities used to provide Special Access Service be specially routed. The regulations, rates and charges for Special Facilities Routing (i.e., Avoidance, Diversity and Cable-Only) are set forth in 11. following.

7.1.6 Design Layout Report

At the request of the customer, the Telephone Company will provide to the customer the make-up of the facilities and services provided under this tariff as Special Access Service to aid the customer in designing its overall service. This information will be provided in the form of a Design Layout Report. The Design Layout Report will be provided to the customer at no charge, and will be reissued or updated whenever these facilities are materially changed.

7.1.7 Acceptance Testing

At no additional charge, the Telephone Company will, at the customer's request, cooperatively test at the time of installation, the following parameters:

Issued: February 7, 1992

Effective: March 31, 1992

PUBLIC SERVICE COMMISSION  
OF KENTUCKY  
EFFECTIVE

MAR 3 1992

PURSUANT TO 807 KAR 5.011.

SEAL (361)

BY: George D. Miller  
PUBLIC SERVICE COMMISSION MANAGER

Robert E. Aigmon for President, Cincinnati, Ohio

**Vice President - Regulatory Affairs**

ACCESS SERVICE TARIFF  
PSCK No. 2

CINCINNATI BELL TELEPHONE COMPANY

1st Revised Page 291  
Cancels Original Page 291

7. Special Access Service (Cont'd)

7.1 General (Cont'd)

7.1.7 Acceptance Testing (Cont'd)

- (A) For Voice Grade analog services, except WATS Access Line, acceptance tests will include tests for loss, 3-tone slope, DC continuity, operational signaling, C-notched noise, and C-message noise when these parameters are applicable and specified in the order for service. Additionally, for Voice Grade services, a balance (improved loss) test will be made if the customer has ordered the improved loss optional feature.
- (B) For other analog services (i.e., Metallic, Telegraph, Program Audio, and Voice Grade WATS Access Line) and for digital services (i.e., Digital Data and High Capacity), acceptance tests will include tests for the parameters applicable to the service as specified in the appropriate Technical Reference document listed in 7.2 following.

In addition to the above tests, Additional Cooperative Acceptance Testing Voice Grade service to test other parameters, as described in 13.3.5(B) following, is available at the customer's request. All test results will be made available to the customer upon request.

7.1.8 Ordering Options and Conditions

Special Access Service ~~may~~ be provisioned to the customer by ~~an~~ Access Order. Details of the ordering process are set forth in Section 5, preceding. Also included in that Section are other charges ~~which may~~ be associated with ordering Special Access Service (e.g., Service Date Change Charges, Cancellation Charges, etc.).

(C)

(C)

PUBLIC SERVICE COMMISSION  
OF KENTUCKY  
EFFECTIVE

MAY 23 1995

PURSUANT TO 807 KAR 5.011,  
SECTION 9(1)

BY: Jordan C. Neal  
FOR THE PUBLIC SERVICE COMMISSION

Issued: ~~June~~ 13, 1995

Effective: ~~May~~ 23, 1995

  
Deborah A. Niseth, President, Cincinnati, Ohio  
Vice President  
Integrated Corporate Planning for

ACCESS SERVICE TARIFF  
PSCK No. 2

CINCINNATI BELL TELEPHONE COMPANY

Original Page 292

7. Special Access Service (Cont'd)

7.2 Service Descriptions

For the purpose of ordering, there are six categories of Special Access Service. These are:

Metallic (MT)  
Telegraph Grade (TG)  
Voice (VG)  
Program Audio (AP)  
Digital Data (DA)  
High Capacity (HC)

Each service consists of a basic channel to which a technical specifications package (customized or predefined), channel interface(s) and, when desired, optional features and functions are added to construct the service desired by the customer. Each of the components of the service is described in this section.

Customized technical specifications packages will be provided where technically feasible. If the Telephone Company determines that the requested parameter specifications are not compatible, the customer will be advised and given the opportunity to change the order.

When a customized channel is ordered the customer will be notified whether Additional Engineering Charges apply. In such cases, the customer will be given an estimate of the hours to be billed before any further action is taken on the order.

The channel description specifies the characteristics of the basic channel and indicates whether the channel is provided between customer designated premises or between a customer designated premises and a Telephone Company hub where bridging or multiplexing functions are performed.

PUBLIC SERVICE COMMISSION  
OF KENTUCKY  
EFFECTIVE

MAR 3 1992

PURSUANT TO 807 KAR 5:011,  
SECTION 9 (1)

BY: Shayna Deller  
PUBLIC SERVICE COMMISSION MANAGER

Issued: February 7, 1992

Effective: March 3, 1992

Robert E. Aigwon for

President, Cincinnati, Ohio

**Vice President - Regulatory Affairs**

ACCESS SERVICE TARIFF  
PSCK No. 2

CINCINNATI BELL TELEPHONE COMPANY

Original Page 293

7. Special Access Service (Cont'd)

7.2 Service Descriptions (Cont'd)

Information pertaining to the technical specifications packages indicates the transmission parameters that are available with each package. This information is displayed in a matrix with the transmission parameters listed down the left side and the packages listed across the top. Each package is identified by a code, e.g., VGC. The first two letters of the code indicate the category of Special Access Service to which the parameters are applicable. These two letter codes are shown above in parentheses following the category of Special Access Service. The letter "C" following the two letter code indicates the technical specifications package for a customized service. An alpha, numeric or alpha-numeric designation following the two letter code indicates the specific predefined package. For a customized service, the customer may select any parameters available with that category of service as long as the parameters are compatible. When appropriate, the Technical Reference which contains detailed specifications for the parameters is shown following the matrix.

Channel interfaces at each Point of Termination on a two-point service may be symmetrical or asymmetrical. On a multipoint service they may also be symmetrical or asymmetrical, but communications can only be provided between compatible channel interfaces. Only certain channel interfaces are compatible. These are set forth in the appropriate Technical References.

Only certain channel interfaces combinations are available with the predefined technical specifications packages. These are delineated in the Technical References set forth in the service descriptions for each service offering. When a customized channel is requested, all channel interface combinations available with the specified type of service are available with the customized channel.

The optional features and functions available with each type of Special Access Service are described in this section. The optional features and functions information also indicates with which technical specifications packages they are available. Such information is displayed in a matrix with the optional feature or function listed down the left side and the technical specifications packaged listed across the top.

MAR 3 1992

PURSUANT TO 807 KAR 5:011,  
SECTION 9 (1)

Issued: February 7, 1992

*Robert E. Aigmon*

for

President, Cincinnati, Ohio

Effective: *March 3, 1992*  
PUBLIC SERVICE COMMISSION

**Vice President - Regulatory Affairs**

ACCESS SERVICE TARIFF  
PSC No. 2

CINCINNATI BELL TELEPHONE COMPANY

Original Page 294

7. Special Access Service (Cont'd)

7.2 Service Descriptions (Cont'd)

The Telephone Company will maintain existing transmission specifications on services installed prior to the effective date of this tariff, except that existing services with performance specifications exceeding the standards listed in this provision will be maintained at the performance levels specified in this tariff.

All services installed after the effective date of this tariff will conform to the transmission specification standards contained in this tariff or in the following Technical References for each category of service:

|                  |                    |
|------------------|--------------------|
| Metallic         | TR-NPL-000336      |
| Telegraph Grade  | TR-NPL-000336      |
| Voice Grade      | TR-NPL 000335      |
|                  | PUB 41004, Table 4 |
| Program Audio    | TR-NPL-000337      |
| Digital Data     | TR-NPL-000341      |
|                  | PUB 62310          |
| High Capacity    | TR-NPL-000054      |
|                  | TR-TSY-000342      |
| WATS Access Line | TR-NPL 000334      |

PUBLIC SERVICE COMMISSION  
OF KENTUCKY  
EFFECTIVE

MAR 3 1992

PURSUANT TO 807 KAR 5:011,

SECTION 9 (1)

Effective: March 3, 1992  
BY: Robert E. Sigmon  
PUBLIC SERVICE COMMISSION MANAGER

Issued: February 7, 1992

Robert E. Sigmon for

President, Cincinnati, Ohio

Vice President - Regulatory Affairs

ACCESS SERVICE TARIFF  
PSCK No. 2

CINCINNATI BELL TELEPHONE COMPANY

Original Page 295

7. Special Access Service (Cont'd)

7.2 Service Descriptions (Cont'd)

7.2.1 Metallic Service (Cont'd)

(A) Basic Channel Description

A Metallic channel is an unconditioned two-wire channel capable of transmitting low speed varying signals at rates up to 30 baud. This channel is provided by metallic or equivalent facilities. Metallic channels are provided between customer designated premises or between a customer designated premises and a Telephone Company hub where bridging functions are performed. Interoffice metallic facilities will be limited in length to a total of five miles per channel.

(B) Technical Specifications Packages

| <u>Parameter</u>                    | <u>Package MT-</u> |          |          |          |
|-------------------------------------|--------------------|----------|----------|----------|
|                                     | <u>C</u>           | <u>1</u> | <u>2</u> | <u>3</u> |
| DC Resistance<br>Between Conductors | X                  | X        | X        |          |
| Loop Resistance                     | X                  |          |          | X        |
| Shunt Capacitance                   | X                  |          |          | X        |

The technical specifications are delineated in Technical Reference TR-NPL-000336.

PUBLIC SERVICE COMMISSION  
OF KENTUCKY  
EFFECTIVE

MAR 3 1992

PURSUANT TO 807 KAR 5:011,  
SECTION 9 (1)

BY: Chas. Haller

Effective March 3, 1992  
PUBLIC SERVICE COMMISSION MANAGER

Issued: February 7, 1992

Robert E. Sigmon for

President, Cincinnati, Ohio

Vice President - Regulatory Affairs



ACCESS SERVICE TARIFF  
PSCK No. 2

CINCINNATI BELL TELEPHONE COMPANY

Original Page 296

7. Special Access Service (Cont'd)

7.2 Service Descriptions (Cont'd)

7.2.1 Metallic Service (Cont'd)

(C) Channel Interfaces

The following channel interfaces identify the direct current or voltage at the interface.

| <u>CI</u> | <u>DC/Voltage</u>                     |
|-----------|---------------------------------------|
| DC-1      | Monitoring with series RC combination |
| DC-2      | <b>Energized</b> interface            |
| DC-3      | DC Continuity                         |

Compatible channel interfaces are set forth in Technical Reference TP-NPL-000336.

(D) Optional Features and Functions

(1) Central Office Bridging Capability

- (a) Three Premises Bridging - Provision of tip-to-tip and ring-to-ring connection in a central office of a metallic pair to a third customer designated premises.
- (b) Series Bridging of up to 26 customer designated premises.

The following table shows the technical specifications packages with which the optional features and functions are available.

|                         | <u>Available with Technical Specifications Package MT-</u> |          |          |          |
|-------------------------|--|----------|----------|----------|
|                         | <u>C</u>   | <u>1</u> | <u>2</u> | <u>3</u> |
| Three Premises Bridging | X  | X        |          |          |
| Series Bridging         | X  |          | X        |          |

MAR 3 1992

PURSUANT TO 807 KAR 5:011,  
SECTION 9 (1)

BY: *[Signature]*  
Effective: March 3, 1992  
PUBLIC SERVICE COMMISSION MANAGER

Issued: February 7, 1992

*Robert E. Sigmon* <sup>ICF</sup> President, Cincinnati, Ohio

Vice President - Regulatory Affairs

7. Special Access Service (Cont'd)

7.2 Service Descriptions (Cont'd)

7.2.2 Telegraph Grade Service

(A) Basic Channel Description

A Telegraph Grade channel is an unconditioned channel capable of transmitting binary signals at rates of 0-75 baud or 0-150 baud. This channel is furnished for half-duplex or duplex operation. Telegraph Grade channels are provided between customer designated premises or between a customer designated premises and a Telephone Company hub.

(B) Technical Specifications Packages

| <u>Parameter</u>     | <u>Package TG-</u> |          |          |
|----------------------|--------------------|----------|----------|
|                      | <u>0</u>           | <u>1</u> | <u>2</u> |
| Telegraph Distortion | X                  | X        | X        |

The technical specifications are delineated in Technical Reference TR-NPL-000336.

(C) Channel Interfaces

Following are channel interfaces normally associated with with Telegraph Grade Service.

| <u>CI</u> | <u>Definition</u>    |
|-----------|----------------------|
| TT2       | 20 Ma                |
| TT3       | 3 Ma                 |
| TT6       | 62.5 Ma              |
| DB10      | 108 Data Set         |
| DB43      | 43 Telegraph Carrier |
| IA        | E.I.A. RS-232        |

Compatible channel interfaces are set forth in Technical Reference TR-NPL-000336.

PUBLIC SERVICE COMMISSION  
OF KENTUCKY  
EFFECTIVE

MAR 3 1992

PURSUANT TO 807 KAR 5:011,  
SECTION 9(1)

Issued: February 7, 1992

Effective: March 3, 1992  
PUBLIC SERVICE COMMISSION

*Robert E. Aigmon* for President, Cincinnati, Ohio

Vice President - Regulatory Affairs

ACCESS SERVICE TARIFF  
PSCK No. 2

CINCINNATI BELL TELEPHONE COMPANY

1st Revised Page 298  
Cancels Original Page 298

7. Special Access Service (Cont'd)

7.2 Service Descriptions (Cont'd)

7.2.2 Telegraph Grade Service (Cont'd)

(D) Optional Features and Functions

(1) Telegraph Bridging (two-wire and four-wire)

The following table shows the technical specifications packages with which the optional features and functions are available.

|                    | Available with Technical Specifications Package TG- |   |   |
|--------------------|---|---|---|
|                    | C   | 1 | 2 |
| Telegraph Bridging | X   | X | X |

7.2.3 Voice Grade Service

(A) Basic Channel Description

A Voice Grade channel is a channel which provides voice frequency transmission capability in the nominal frequency range of 300 to 3000 Hz and may be terminated two-wire or four-wire. Voice Grade channels are provided between customer designated premises, between a customer designated premises and a Telephone Company hub or as a WATS Access Line (WAL) between a customer designated premises and a WATS Serving office (WSO).

WAL Service is associated with the closed end of 800 Service, WATS or similar services. It is provided for use with Switched Access Service as set forth in Section 6 preceding.

WAL Service is arranged for either originating calling, terminating calling, or two way calling. It is provided with either rotary dial or dual tone multifrequency address signaling and either loop start, ground start, E&M or reverse battery supervisory signaling. The choice of signaling is at the option of the customer and subject to the technical limitations identified in the Technical Reference TR-NPL-000334.

(C)  
|  
(C)

PUBLIC SERVICE COMMISSION  
OF KENTUCKY  
EFFECTIVE  
APR 5 1992  
PURSUANT TO 807 KAR 5.011.  
SECTION 9 (1)  
BY: *Shawn Holloway*  
PUBLIC SERVICE COMMISSION MANAGER

Issued: March 6, 1992

Effective: March 17, 1992

*Robert E. Aignone*

President, Cincinnati, Ohio

Issued By Authority of an Order of the Public Service Commission of Kentucky in Case No. 323 Phase III dated December 18, 1991

Vice President - Regulatory Affairs

ACCESS SERVICE TARIFF  
PSCK No. 2

CINCINNATI BELL TELEPHONE COMPANY

Original Page 299

7. Special Access Service (Cont'd)

7.2 Service Descriptions (Cont'd)

7.2.3 Voice Grade Service (Cont'd)

(B) Technical Specifications Packages

| Parameter          | Package VG- |   |   |   |   |   |   |   |   |   |    |    |    | W |
|--------------------|-------------|---|---|---|---|---|---|---|---|---|----|----|----|---|
|                    | C*          | 1 | 2 | 3 | 4 | 5 | 6 | 7 | 8 | 9 | 10 | 11 | 12 |   |
| Attenuation        |             |   |   |   |   |   |   |   |   |   |    |    |    |   |
| Distortion         | X           | X | X | X | X | X | X | X | X | X | X  | X  | X  | X |
| C-Message Noise    | X           | X | X | X | X | X | X | X | X | X | X  | X  | X  | X |
| Echo Control       | X           | X | X | X |   | X |   | X | X |   |    | X  | X  | X |
| Envelope Delay     |             |   |   |   |   |   |   |   |   |   |    |    |    |   |
| Distortion         | X           |   |   |   |   |   | X | X | X | X | X  | X  | X  | X |
| Frequency Shift    | X           |   |   |   |   |   | X | X | X | X | X  | X  | X  | X |
| Impulse Noise      | X           |   |   |   |   | X | X | X | X | X | X  | X  | X  | X |
| Intermodulation    |             |   |   |   |   |   |   |   |   |   |    |    |    |   |
| Distortion         | X           |   |   |   |   |   | X | X | X | X | X  | X  |    | X |
| Loss Deviation     | X           | X | X | X | X | X | X | X | X | X | X  | X  | X  | X |
| Phase Hits, Gain   |             |   |   |   |   |   |   |   |   |   |    |    |    |   |
| Hits, and Dropouts | X           |   |   |   |   |   |   |   |   |   |    |    |    |   |
| Phase Jitter       | X           |   |   |   |   |   | X | X | X | X | X  | X  |    | X |
| Signal-to-C        |             |   |   |   |   |   |   |   |   |   |    |    |    |   |
| Message Noise      |             |   |   | X |   |   |   |   |   |   |    |    |    |   |
| Signal-to-C        |             |   |   |   |   |   |   |   |   |   |    |    |    |   |
| Notch Noise        | X           |   |   |   | X | X | X | X | X | X | X  | X  | X  | X |

PUBLIC SERVICE COMMISSION  
OF KENTUCKY  
EFFECTIVE

MAR 3 1992

\*The desired parameters are selected by the customer from the list of available parameters.

PURSUANT TO 807 KAR 5:011  
SECTION 9 (1)

Issued: February 7, 1992

Effective: March 3, 1992  
PUBLIC SERVICE COMMISSION

*Robert E. Bignone* for President, Cincinnati, Ohio

Vice President - Regulatory Affairs

ACCESS SERVICE TARIFF  
PSCK No. 2

CINCINNATI BELL TELEPHONE COMPANY

Original Page 300

7. Special Access Service (Cont'd)

7.2 Service Descriptions (Cont'd)

7.2.3 Voice Grade Service (Cont'd)

(B) Technical Specifications Packages (Cont'd)

The technical specifications for these parameters (except for dropouts, gain hits, and phase hits) are delineated in Technical References TR-NPL-000334 and TR-NPL-000335. The technical specifications for dropouts, phase hits, and gain hits are determined in Technical Reference PUB 41004, Table 4.

(C) Channel Interfaces

The following channel interfaces for Voice Grade service do not require signaling capability: DA, DB, DD, DE, DS, NO, PR and TF.

The following channel interfaces for Voice Grade service require signaling capability: AB, AC, CT, DX, DY, EA, EB, EC, EX, GO, GS, LA, LB, LC, LO, LR, LS, RV and SF.

The following interfaces are available with WAL Service: LO, LS, DS, GO, GS, EB.

Compatible Voice Grade channel interfaces and available WAL channel interfaces are set forth in Technical References TR-NPL-000334 and TR-NPL-000335.

(D) Optional Features and Functions

(1) Central Office Bridging Capability

- (a) Voice and WAL Bridging (two-wire and four-wire)
- (b) Data Bridging (two-wire and four-wire)
- (c) Telephoto Bridging (two-wire and four-wire)
- (d) DATAPHONE Select-A-Station Bridging with sequential arrangement ports or addressable arrangement ports

PUBLIC SERVICE COMMISSION  
OF KENTUCKY  
EFFECTIVE

MAR 3 1992

PURSUANT TO 807 KAR 5:011,  
SECTION 9 (1)

BY: *Clara Keller*

Issued: February 7, 1992

Effective: *March 3, 1992*

*Robert E. Aigmon*

for

President, Cincinnati, Ohio

Vice president - Regulatory Affairs

ACCESS SERVICE TARIFF  
PSCK No. 2

CINCINNATI BELL TELEPHONE COMPANY

Original Page 301

7. Special Access Service (Cont'd)

7.2 Service Descriptions (Cont'd)

7.2.3 Voice Grade Service (Cont'd)

(D) Optional Features and Functions (Cont'd)

(2) Conditioning

Conditioning provides more specific transmission characteristics for Voice Grade services. C-Type conditioning controls attenuation distortion and envelope delay distortion. Sealing Current helps maintain continuity on dry metallic loops.

For two-point services, the parameters apply to each service. For multipoint services, the parameters apply to each mid-link or end link. C-Type conditioning and Data Capability may be combined on the same service.

**PUBLIC SERVICE COMMISSION  
OF KENTUCKY  
EFFECTIVE**

MAR 3 1992

**PURSUANT TO 807 KAR 5:011,  
SECTION 9 (1)**

BY: Glenn Sella  
PUBLIC SERVICE COMMISSION MANAGER

Issued: February 7, 1992

Effective: March 3, 1992

Robert C. Sigmon for President, Cincinnati, Ohio

**Vice President - Regulatory Affairs**

ACCESS SERVICE TARIFF  
PSCK No. 2

CINCINNATI BELL TELEPHONE COMPANY

Original Page 302

7. Special Access Service (Cont'd)

7.2 Service Descriptions (Cont'd)

7.2.3 Voice Grade Service (Cont'd)

(D) Optional Features and Functions (Cont'd)

(2) Conditioning (Cont'd)

(a) C-Type Conditioning

C-Type Conditioning is provided for the additional control of attenuation distortion and envelope delay distortion on data services. The attenuation distortion and envelope delay distortion specifications for C-Type Conditioning are delineated in Technical Reference TR-NPL-000335.

PUBLIC SERVICE COMMISSION  
OF KENTUCKY  
EFFECTIVE

MAR 3 1992

PURSUANT TO 807 KAR 5:011,  
SECTION 9(1)

Issued: February 7, 1992

Effective: March 3, 1992

PUBLIC SERVICE

*Robert E. Sigmon*

for

President, Cincinnati, Ohio

**Vice President - Regulatory Affairs**

ACCESS SERVICE TARIFF  
PSCK No. 2

CINCINNATI BELL TELEPHONE COMPANY

Original Page 303

7. Special Access Service (Cont'd)

7.2 Service Descriptions (Cont'd)

7.2.3 Voice Grade Service (Cont'd)

(D) Optional Features and Functions (Cont'd)

(2) Conditioning (Cont'd)

(a) C-Type Conditioning (Cont'd)

| Frequency<br>Range (Hz) | Envelope Delay<br>Distortion     |
|-------------------------|----------------------------------|
|                         | Variation<br>(micro-<br>seconds) |
| 1000-2600               | 100                              |
| 800-2600                | 200                              |
| 600-2600                | 300                              |
| 500-2800                | 600                              |
| 500-3000                | 3000                             |

PUBLIC SERVICE COMMISSION  
OF KENTUCKY  
EFFECTIVE

MAR 3 1992

PURSUANT TO 807 KAR 5.011.

Issued: February 7, 1992

Effective: SECTION 9.11  
March 3, 1992  
BY: [Signature]  
PUBLIC SERVICE COMMISSION

[Signature] for President, Cincinnati, Ohio

Vice President - Regulatory Affairs



ACCESS SERVICE TARIFF  
PSCK No. 2

CINCINNATI BELL TELEPHONE COMPANY

Original Page 304

7. Special Access Service (Cont'd)

7.2 Service Descriptions (Cont'd)

7.2.3 Voice Grade Service (Cont'd)

(D) Optional Features and Functions (Cont'd)

(2) Conditioning (Cont'd)

(b) Sealing Current Conditioning

Sealing Current Conditioning is provided to help maintain continuity on dry metallic loops. It is usually associated with four-wire DA or NO type channel interfaces.

(3) Customer Specified Premises Receive Level

This option allows the customer to specify the receive level at the Point of Termination. The level must be within a specific range on effective four-wire transmission. The ranges are delineated in Technical References TR-NPL-000334 and TR-NPL-000335.

PUBLIC SERVICE COMMISSION  
OF KENTUCKY  
EFFECTIVE

MAR 3 1992

Issued: February 7, 1992

PURSUANT TO 807 KAR 5:011,  
Effective: ~~March 3, 1992~~ March 3, 1992

*W. C. Symon* for  
President, Cincinnati, Ohio

BY: *George Helle*  
PUBLIC SERVICE COMMISSION MANAGER

Vice President - Regulatory Affairs

7. Special Access Service (Cont'd)

7.2 Service Descriptions (Cont'd)

7.2.3 Voice Grade Service (Cont'd)

(D) Optional Features and Functions (Cont'd)

(4) Improved Termination

On effective Four-Wire Transmission at Four-Wire Point of Termination (applicable to each two-wire port): Provides for a fixed **600 ohm** impedance, variable level range and simplex reversal. Telephone Company equipment is required at the customer's premises where this option is ordered. The Improved Termination parameters are delineated in Technical Reference TR-NPL-000335.

(5) Improved Return Loss

On Effective Two-Wire Transmission at Two-Wire Point of Termination: Provides for more stringent Echo Control specifications. In order for this option to be applicable, the transmission path must be four-wire at one POT and two-wire at the other POT. Placement of Telephone Company equipment may be required at the customer's premises with the two-wire POT. The Improved Return Loss parameters are delineated in Technical References TR-NPL-000334 and TR-NPL-000335.

(6) Data Capability

Data Capability provides transmission characteristics suitable for data communications. Specifically, Data Capability provides for the control of Signal to C-Notched Noise Ratio and intermodulation distortion. It is available for two-point services or multipoint services.

PUBLIC SERVICE COMMISSION  
OF KENTUCKY  
EFFECTIVE

MAR 3 1992

PURSUANT TO 807 KAR 5:011,

Effective: ~~MARCH 1992~~ (1992)

Issued: February 7, 1992  
*Robert E. Aigmon* for  
President, Cincinnati, Ohio

BY: *George Bell*  
PUBLIC SERVICE COMMISSION MANAGER

**Vice President - Regulatory Affairs**

ACCESS SERVICE TARIFF  
PSC No. 2

CINCINNATI BELL TELEPHONE COMPANY

Original Page 306

7. Special Access Service (Cont'd)

7.2 Service Descriptions (Cont'd)

7.2.3 Voice Grade Service (Cont'd)

(D) Optional Features and Functions (Cont'd)

(6) Data Capability (Cont'd)

The Signal to C-Notched Noise Ratio and inter-modulation distortion parameters for Data Capability are:

- Signal to C-Notched Noise Ratio is equal to or greater than 32dB
- Intermodulation distortion:
  - Signal to second order modulation products (R2) is equal to or greater than 38dB.
  - Signal to third order modulation products (R3) is equal to or greater than 42dB.

When a service equipped with Data Capability is used for voice communications, the quality of the voice transmission may not be satisfactory.

(7) Telephoto Capability

Telephoto Capability provides transmission characteristics suitable for telephotographic communications. Specifically, Telephoto Capability is provided for the control of attenuation distortion and envelope delay distortion on telephotographic services. The attenuation distortion and envelope delay distortion parameters for Telephoto Capability are:

Attenuation Distortion  
(2204Hz Reference)

| Frequency Range (Hz) | Variation (dB) |
|----------------------|----------------|
| 500-3000             | -0.5 to +1.5   |
| 300-3200             | -1.0 to +2.5   |

PUBLIC SERVICE COMMISSION  
OF KENTUCKY  
EFFECTIVE

MAR 3 1992

Issued: February 7, 1992

*Robert E. Sigmon*

for

President, Cincinnati, Ohio

PURSUANT TO 807 KAR 5.011.  
Effective: March 3, 1992  
SECTION 9 (1)

BY: *Cheryl L. Hester*  
PUBLIC SERVICE COMMISSION MANAGER

Vice President - Regulatory Affairs

ACCESS SERVICE TARIFF  
PSCK No. 2

CINCINNATI BELL TELEPHONE COMPANY

Original Page 307

7. Special Access Service (Cont'd)

7.2 Service Descriptions (Cont'd)

7.2.3 Voice Grade Service (Cont'd)

(D) Optional Features and Functions (Cont'd)

(7) Telephoto Capability (Cont'd)

Envelope Delay Distortion

| <u>Frequency<br/>Range (Hz)</u> | <u>Variation<br/>(mcs)</u> |
|---------------------------------|----------------------------|
| 1000-2600                       | 110                        |
| 800-2800                        | 180                        |

(8) Signaling Capability

Signaling Capability provides for the process by which one customer premises alerts another customer premises on the same service with which it wishes to communicate.

(9) Selective Signaling Arrangement

An arrangement that permits code selective ringing for up to ten codes on a multipoint service.

(10) Transfer Arrangement

An arrangement that affords customers an additional measure of flexibility in the use of their access channel(s). The arrangement can be utilized to transfer a leg of a Special Access Service to another channel that terminates in either the same or a different customer premises. A key activated control service is required to operate the transfer arrangement. A spare channel, if required, is not included as part of

PUBLIC SERVICE COMMISSION  
OF KENTUCKY  
EFFECTIVE

MAR 3 1992

PURSUANT TO 807 KAR 5:011.  
SECTION 9 (1)

Effective March 3, 1992  
BY: [Signature]  
PUBLIC SERVICE COMMISSION MANAGER

Issued: February 7, 1992

Robert E. Aigmore for President, Cincinnati, Ohio

Vice President - Regulatory Affairs

ACCESS SERVICE TARIFF  
PSCK No. 2

CINCINNATI BELL TELEPHONE COMPANY

Original Page 308

7. Special Access Service (Cont'd)

7.2 Service Descriptions (Cont'd)

7.2.3 Voice Grade Service (Cont'd)

(D) Optional Features and Functions (Cont'd)

The following table shows the technical specifications packages with which the optional features and functions are available.

| Parameter                                 | Available with Technical Specifications Package VG- |   |   |   |   |   |   |   |   |   |    |    |    | W |
|---|---|---|---|---|---|---|---|---|---|---|----|----|----|---|
|   | C   | 1 | 2 | 3 | 4 | 5 | 6 | 7 | 8 | 9 | 10 | 11 | 12 |   |
| C-Type Conditioning Central Office        | X   |   |   |   |   | X | X | X | X | X | X  |    |    |   |
| Bridging Capability                       | X   |   | X |   |   | X | X |   |   |   | X  | X  | X  | X |
| Customer Specified Premises Receive Level | X   |   | X | X |   |   |   | X | X | X |    |    |    | X |
| Data Capability                           | X   |   |   |   |   |   | X | X |   |   | X  |    |    |   |
| Improved Termination                      | X   | X | X | X | X | X | X | X | X | X | X  | X  | X  |   |
| Improved Return Loss                      | X   |   | X | X |   |   |   | X |   |   |    |    |    | X |
| Improved Two-Wire Voice Transmission      |   |   |   |   |   |   |   |   |   |   |    |    |    | X |
| Sealing Current Conditioning              | X   |   |   |   |   | X | X |   |   |   | X  |    |    |   |
| Selective Signaling Arrangement           | X   |   | X |   |   |   |   |   |   |   |    |    |    |   |
| Signaling Capability                      | X   | X | X | X |   |   |   | X | X | X |    |    |    |   |
| Telephoto Capability                      | X   |   |   |   |   |   |   |   |   |   |    |    | X  |   |
| Transfer Arrangement                      | X   | X | X | X | X | X | X | X | X | X | X  | X  | X  | X |

PUBLIC SERVICE COMMISSION  
OF KENTUCKY  
EFFECTIVE

MAR 3 1992

PURSUANT TO 807 KAR 5:011,  
SECTION 9 (1)

BY: Sharon Keller  
PUBLIC SERVICE COMMISSION MANAGER

Issued: February 7, 1992

Effective: March 3, 1992

Robert E. Sigmon for President, Cincinnati, Ohio

Vice President - Regulatory Affairs

ACCESS SERVICE TARIFF  
PSCK No. 2

CINCINNATI BELL TELEPHONE COMPANY

Original Page 309

7. Special Access Service (Cont'd)

7.2 Service Descriptions (Cont'd)

7.2.3 Voice Grade Service (Cont'd)

(E) Four-Wire/Two-Wire Conversions

When a customer requests that an effective four-wire channel be terminated with a two-wire channel interface at the customer designated premises, a four-wire to two-wire conversion is required. The rate for the conversion is included as part of the basic Channel Termination rate.

(F) WAL Improved Two-Wire Voice Transmission

Two-wire Voice Grade Special Access Service for use as a WATS Access Line (WAL) may be ordered as standard or improved. Transmission specifications are set forth in Technical Reference TR-NPL-000334. The rate for the provision of Improved Two-Wire Voice Transmission is included as part of the basic Channel Termination rate.

(G) Certain other options associated with WAL services are either Line Termination or Common Switching optional features as defined in Section 6 preceding.

PUBLIC SERVICE COMMISSION  
OF KENTUCKY  
EFFECTIVE

MAR 3 1992

PURSUANT TO 807 KAR 5:011,  
SECTION 9 (1)

Effective: March 3, 1992  
BY: Robert E. Aigmon  
PUBLIC SERVICE COMMISSION MANAGER

Issued: February 7, 1992

Robert E. Aigmon for  
President, Cincinnati, Ohio

Vice President - Regulatory Affairs

ACCESS SERVICE TARIFF  
PSCK No. 2

CINCINNATI BELL TELEPHONE COMPANY

Original Page 310

7. Special Access Service (Cont'd)

7.2 Service Descriptions (Cont'd)

7.2.4 Program Audio Service

(A) Basic Channel Description

A Program Audio channel is a channel measured in Hz for the transmission of a complex signal voltage. The actual bandwidth is a function of the channel interface selected by the customer. Only one-way transmission is provided. Program Audio channels are provided between customer designated premises or between a customer designated premises and a Telephone Company hub.

(B) Technical Specifications Packages

| Parameter                 | Package AP- |   |   |   |   |
|---------------------------|-------------|---|---|---|---|
|                           | C*          | 1 | 2 | 3 | 4 |
| Actual Measured Loss      | X           | X | X | X | X |
| Amplitude Tracking        | X           |   |   |   |   |
| Crosstalk                 | X           | X | X | X | X |
| Distortion Tracking       | X           |   |   |   |   |
| Gain/Frequency Distortion | X           | X | X | X | X |
| Group Delay               | X           |   |   |   |   |
| Noise                     | X           | X | X | X | X |
| Phase Tracking            | X           |   |   |   |   |
| Short-Term Gain           |             |   |   |   |   |
| Stability                 | X           |   |   |   |   |
| Short-Term Loss           | X           |   |   |   |   |
| Total Distortion          | X           | X | X | X | X |

The technical specifications are delineated in Technical Reference TR-NPL-000337.

(C) Channel Interfaces

The following channel interfaces (CIs) define the bandwidths that are available for a Program

PUBLIC SERVICE COMMISSION  
OF KENTUCKY  
EFFECTIVE

\* The desired parameters are selected by the customer from the list of available parameters.

MAR 3 1992

PURSUANT TO 807 KAR 5:011,  
SECTION 9 (1)

Issued: February 7, 1992  
for  
*Robert E. Sigmon*

President, Cincinnati, Ohio

Effective: *March 3, 1992*  
BY: *[Signature]*  
PUBLIC SERVICE COMMISSION MANAGER

Vice President - Regulatory Affairs

ACCESS SERVICE TARIFF  
PSCK No. 2

CINCINNATI BELL TELEPHONE COMPANY

Original Page 311

7. Special Access Service (Cont'd)

7.2 Service Descriptions (Cont'd)

7.2.4 Proaram Audio Service (Cont'd)

(C) Channel Interfaces (Cont'd)

| CI   | Bandwidth                                   |
|------|---|
| PG-1 | Nominal frequency from 50 to 15000 Hz       |
| PG-3 | Nominal frequency from 200 to 3500 Hz       |
| PG-5 | Nominal frequency from 100 to 5000 Hz       |
| PG-8 | Nominal frequency from 50 to <b>8000</b> Hz |

Compatible channel interfaces are set forth in Technical Reference TR-NPL-000337.

(D) Optional Features and Functions

(1) Central Office Bridging Capability

Distribution Amplifier

(2) Gain Conditioning

Control of 1004 Hz AML at initiation of service to  $\pm 0.5$  dB.

(3) Stereo

Provision of a pair of **gain/phase** equalized channels for stereo applications. (Additional AP channel must be ordered separately.)

The following table shows the technical specifications packages with which the optional features and functions are available.

|                                    | Available with Technical Specifications Package AP- |          |          |          |          |
|------------------------------------|---|----------|----------|----------|----------|
|                                    | <u>C</u>  | <u>1</u> | <u>2</u> | <u>3</u> | <u>4</u> |
| Central Office Bridging Capability | X   | X        | X        | X        | X        |
| Gain Conditioning                  | X   | X        | X        | X        | X        |
| Stereo                             | X   |          |          |          | X        |

**PUBLIC SERVICE COMMISSION  
OF KENTUCKY  
EFFECTIVE**

MAR 3 1992

PURSUANT TO 807 KAR 5:011.

Issued: February 7, 1992

Effective: SECTION 9(1)  
March 3, 1992

*Robert E. Sigmon*

for

President, Cincinnati, Ohio

BY: *Ray Steller*  
PUBLIC SERVICE COMMISSION MANAGER

Vice President - Regulatory Affairs



ACCESS SERVICE TARIFF  
PSC No. 2

CINCINNATI BELL TELEPHONE COMPANY

1st Revised Page 312  
Cancels Original Page 312

7. Special Access Service (Cont'd)

7.2 Service Descriptions (Cont'd)

7.2.5 Reserved

7.2.6 Reserved

7.2.7 Reserved

7.2.8 Digital Data Service

(A) Basic Channel Description

A Digital Data channel is a channel for duplex four-wire transmission of synchronous serial data at the rate of 2.4, 4.8, 19.2, 9.6, 56 or 64 kbps. The actual bit rate is a function of the channel interface selected by the customer. (C)  
The channel provides a synchronous service with timing provided by the Telephone Company through the Telephone Company's facilities to the customer in the received bit stream. Digital Data channels are only available via Telephone Company designated hubs and are provided between customer designated premises or between a customer designated premises and a Telephone Company hub. The 64 kbps speed requires B8ZS Line Code Formatted Signal. The 9.6, 19.2, 56 and 64 kbps Digital Data channels are available for use with Customer Network Reconfiguration Service as described in 7.2.10 following. (C)

ACCESS SERVICE TARIFF  
PSC No. 2

CINCINNATI BELL TELEPHONE COMPANY

Original Page 313

7. Special Access Service (Cont'd)

7.2 Service Descriptions (Cont'd)

7.2.8 Digital Data Service (Cont'd)

(B) Technical Specifications Packages

| Parameter          | Package DA- |   |   |   |   |
|--------------------|-------------|---|---|---|---|
|                    | 1           | 2 | 3 | 4 | 6 |
| Error-Free Seconds | X           | X | X | X | X |

The Telephone Company will provide a channel capable of meeting a monthly average performance equal to or greater than 99.875% error-free seconds while the channel is in service, if it is measured through a CSU equivalent which is designed, manufactured, and maintained to conform with the specifications contained in Technical Reference PUB 62310.

Voltages which are compatible with Digital Data Service are delineated in Technical Reference TR-NPL-000341

**PUBLIC SERVICE COMMISSION  
OF KENTUCKY  
EFFECTIVE**

**MAR 3 1992**

PURSUANT TO 807 KAR 5:011,  
SECTION 9 (1)  
BY: Gloria Keller  
PUBLIC SERVICE COMMISSION MANAGER

Issued: February 7, 1992

Effective: March 3, 1992

Robert E. Aigmon for President, Cincinnati, Ohio

Vice President - Regulatory Affairs

7. Special Access Service (Cont'd)

7.2 Service Descriptions (Cont'd)

7.2.8 Digital Data Service (Cont'd)

(C) Channel Interfaces

The following channel interfaces (CIs) define the bit rates that are available for a Digital Data channel:

| <u>CI</u> | <u>Bit Rate</u> |
|-----------|-----------------|
| DU-24     | 2.4 kbps        |
| DU-48     | 4.8 kbps        |
| DU-96     | 9.6 kbps        |
| DU-19.2   | 19.2 kbps       |
| DU-56     | 56.0 kbps       |
| DU-64     | 64.0 kbps       |

(C)

Compatible channel interfaces are set forth in Technical Reference TR-NPL-000341 and PUB 62310.

(D) Optional Features and Functions

(1) Central Office Bridging Capability

(2) (Reserved)

(3) Secondary Channel Capability

An arrangement that provides the customer the flexibility of utilizing a secondary channel in conjunction with a primary 2.4, 4.8, 9.6, 19.2 or 56 kbps Digital Data Service channel. The secondary channel and primary channel are provided over the same facilities

(C)

ACCESS SERVICE TARIFF  
PSCK No. 2

CINCINNATI BELL TELEPHONE COMPANY

Original Page 315

7. Special Access Service (Cont'd)

7.2 Service Descriptions (Cont'd)

7.2.8 Digital Data Service (Cont'd)

(D) Optional Features and Functions (Cont'd)

(3) Secondary Channel Capability (Cont'd)

as a two-point or multipoint service where available, and must be coterminated in special customer provided equipment. Secondary Channel Capability (SCC) is a derived companion digital transmission path that is independent of the primary data path and operates at a substantially lower bit rate. This derived channel allows the customer to perform network management functions during the normal operation of the network. This diagnostic channel utilizes a portion of a customer's previously unavailable data bit stream allowing for the ability to remotely control and test the network and peripheral devices without taking the network out of service. Due to the transmission equipment restrictions, SCC cannot be provided on 56 Kbps circuits that require the installation of loop repeater equipment for provision of service. The addition of the secondary channel option to an existing Digital Data Service will be treated as a subsequent addition to the existing service and rated as such. SCC is provided as described in Technical Reference TR-NPL-000157.

The following table shows the technical specifications packages with which the optional features and functions are available.

|                                    | Available with Technical Specifications Package DA- |   |   |   |
|------------------------------------|---|---|---|---|
|                                    | 1   | 2 | 3 | 4 |
| Central Office Bridging Capability | X   | X | X | X |
| Secondary Channel Capability       | X   | X | X | X |

**PUBLIC SERVICE COMMISSION  
OF KENTUCKY  
EFFECTIVE  
MAR 3 1992**

PURSUANT TO 807 KAR 5:011,  
SECTION 9 (1)

BY: *Sharon Keller*  
PUBLIC SERVICE COMMISSION MANAGER

Issued: February 7, 1992

Effective: *March 3, 1992*

*Robert E. Aiguon* for President, Cincinnati, Ohio

Vice President - Regulatory Affairs

ACCESS SERVICE TARIFF  
PSCK No. 2

CINCINNATI BELL TELEPHONE COMPANY

Original Page 316

7. Special Access Service (Cont'd)

7.2 Service Descriptions (Cont'd)

7.2.9 High Capacity Service

(A) Basic Channel Description

A High Capacity channel is a channel for the transmission of nominal 64.0 kbps\* or 1.544, 3.152, 6.312, or 274.176 Mbps isochronous serial data. The actual bit rate and framing format is a function of the channel interface selected by the customer. High Capacity channels are provided between customer designated premises, between a customer designated premises and a Telephone Company hub, or Hub to Hub for Customer Network Reconfiguration at 1.544 Mbps transmission.

A MercNET 45 High Capacity channel is a channel for the transmission of nominal 44.736 Mbps isochronous serial data. The actual bit rate and framing format is a function of the channel interface selected by the customer. MercNET 45 High Capacity Service channels are provided between customer designated premises or between a customer designated premises and a Telephone Company Hub.

(B) Technical Specifications Packages

| Parameters         | Package HC- |   |    |   |   |   |
|--------------------|-------------|---|----|---|---|---|
|                    | 0           | 1 | 1C | 2 | 3 | 4 |
| Error-Free Seconds |             | X |    |   |   |   |

\* Available only as a channel of a 1.544 Mbps facility between two Telephone Company Digital Hubs or as a cross connect of two 2.4, 4.8, 9.6, 56.0 or 64.0 kbps channels of two 1.544 Mbps facilities at a Digital Hub(s). The customer must provide system and channel assignment data.

PUBLIC SERVICE COMMISSION  
OF KENTUCKY  
EFFECTIVE

MAR 3 1992

PURSUANT TO 807 KAR 5:011,  
SECTION 9 (1)

Effective BY: March 3, 1992  
PUBLIC SERVICE COMMISSION MANAGER

Issued: February 7, 1992

Robert E. Aiguon for President, Cincinnati, Ohio

Vice President - Regulatory Affairs

ACCESS SERVICE TARIFF  
PSCK No. 2

CINCINNATI BELL TELEPHONE COMPANY

1st Revised Page 317  
Cancels Original Page 317

7. Special Access Service (Cont'd)

7.2 Service Descriptions (Cont'd)

7.2.9 High Capacity Service (Cont'd)

(B) Technical Specifications Packages (Cont'd)

A channel with technical specifications package HCI will be capable of an error-free second performance of **98.75%** over a continuous **24** hour period as measured at the **1.544** Mbps rate through a CSU equivalent which is designed, manufactured, and maintained to conform with the specifications contained in Technical Reference TR TSY **000342**

Extended superframe signalling format may be provisioned and transported on channels with technical specifications package HCI. Testing for such channels is as specified in **7.1.7(B)** and any maintenance testing that is required to maintain the error free second performance specified herein. Additional testing requested by the customer is provided subject to the provisions set forth in **13.3.5** following.

(C) Channel Interfaces

The following channel interfaces (CIs) define the bit rates that are available for a High Capacity channel:

| <u>CI</u> | <u>Bit Rate</u>    |
|-----------|--------------------|
| DS-15*    | 1.544 Mbps (DS1)   |
| DS-27     | 274.176 Mbps (DS4) |
| DS-31     | 3.152 Mbps (DS1C)  |
| DS-44     | 44.736 Mbps (DS3)  |
| DS-63     | 6.312 Mbps (DS2)   |

Compatible channel interfaces are set forth in Technical References **TR-NPL-000054** and **TR-TSY-000342**.

(D) Optional Features and Functions

- (1) Alternate Central Office Channel - Provides a transmission path for services between the customer's premises and a wire center which is not the customer's serving wire

PUBLIC SERVICE COMMISSION  
OF KENTUCKY  
EFFECTIVE

OCT 26 1992

(N)  
|  
(N)

\* A 64.0 kbps channel is available as a channel(s) of a 1.544 Mbps to 801 KAS 5011, to a Telephone Company hub.

PURSUANT TO KRS 5011.011,  
SECTION 9 (1)  
Effective October 26, 1992  
PUBLIC SERVICE COMMISSION MANAGER

Issued: September 24, 1992

Robert E. Aigmon

for President, Cincinnati, Ohio

Vice President - Regulatory Affairs?

7. Special Access Service (Cont'd)

7.2 Service Descriptions (Cont'd)

7.2.9 High Capacity Service (Cont'd)

(D) Optional Features and Functions (Cont'd)

(1) center, thus avoiding the office which would normally serve the customer. It is available only where facilities exist using 1.544 and 45 mbps high capacity service. (C)

(2) Service To Service Through Connect Arrangement - This provides for the interconnection of two 1.544 Mbps channels extended from multiplexed DS3 high capacity services. The ordering customer must provide channel assignments for both multiplexed services. This service can only be provided when both multiplexed DS3's are in the same wire center.

(3) Central Office Multiplexing

(a) DS4 to DS1

An arrangement that converts a 274.176 Mbps channel to 168 DS1 channels using digital time division multiplexing.

(b) DS3 to DS1

An arrangement that converts a 44.736 Mbps channel to 28 DS1 channels using digital time division multiplexing.

ACCESS SERVICE TARIFF  
PSCK No. 2

CINCINNATI BELL TELEPHONE COMPANY

Original Page 319

7. Special Access Service (Cont'd)

7.2 Service Descriptions (Cont'd)

7.2.9 High Capacity Service (Cont'd)

(D) Optional Features and Functions (Cont'd)

(3) Central Office Multiplexing (Cont'd)

(c) DS2 to DS1

An arrangement that converts a 6.312 Mbps channel to four DS1 channels using digital time division multiplexing.

(d) DS1C to DS1

An arrangement that converts a 3.152 Mbps channel to two DS1 channels using digital time division multiplexing.

(e) DS1 to Voice

An arrangement that converts a 1.544 Mbps channel to 24 channels for use with Voice Grade Services. A channel(s) of this DS1 to the Hub can also be used for Program Audio, Metallic or WATS Access Line Service.

(f) DS1 to Digital Data

An arrangement that converts a 1.544 Mbps channel to 24 channels for use with individual digital data circuits to the Hub at speeds of 2.4, 4.8, 9.6, 56, or 64 Kbps. A channel of this DS1 to the Hub can also be used for Voice Grade, Program Audio, Metallic or WATS Access Line Service.

(g) DS1 to DSO

An arrangement that converts a 1.544 Mbps channel to 23 64 kbps channels utilizing digital time division multiplexing. This arrangement can be provided with the Second Channel Capability feature of Digital Data Service.

**PUBLIC SERVICE COMMISSION  
OF KENTUCKY  
EFFECTIVE**

MAR 3 1992

**PURSUANT TO 807 KAR 5:011,  
SECTION 9 (!)**

Issued: February 7, 1992

Effective: March 3, 1992  
BY: [Signature]  
PUBLIC SERVICE COMMISSION MANAGER

Robert E. Aigmon for President, Cincinnati, Ohio

Vice President - Regulatory Affairs



ACCESS SERVICE TARIFF  
PSCK No. 2

CINCINNATI BELL TELEPHONE COMPANY

Original Page 320

7. Special Access Service (Cont'd)

7.2 Service Descriptions (Cont'd)

7.2.9 High Capacity Service (Cont'd)

(D) Optional Features and Functions (Cont'd)

(3) Central Office Multiplexing (Cont'd)

(h) DSO to Subrate

An arrangement that converts a 64.0 kbps channel to subspeeds of up to twenty 2.4 kbps, ten 4.8 kbps, or five 9.6 kbps channels using digital time division multiplexing. This arrangement can be provided with the Secondary Channel Capability feature of Digital Data Service.

(4) Clear Channel Capability

Clear Channel Capability is an optional feature that provides the customer with an increase in useable bandwidth from 1.344 Mbps to 1.536 Mbps of an unconstrained data stream across the network. Clear Channel Capability is provided only on 1.544 Mbps High Capacity service and requires the customer signal at the channel interface to conform to Bipolar with Eight Zero Substitution (B8ZS) line code format as described in Technical Reference TR-TSY-000342. Customer equipment must be compatible with this method of providing the unconstrained signal.

PUBLIC SERVICE COMMISSION  
OF KENTUCKY  
EFFECTIVE

MAR 3 1992

PURSUANT TO 807 KAR 5:011,  
SECTION 9(1)

BY: Cheryl Hallee  
PUBLIC SERVICE COMMISSION MANAGER

Issued: February 7, 1992

Effective: March 3, 1992

Robert E. Aigmon for President, Cincinnati, Ohio

Vice President - Regulatory Affairs

ACCESS SERVICE TARIFF  
PSCR No. 2

CINCINNATI BELL TELEPHONE COMPANY

Original Page 320.1

PUBLIC SERVICE COMMISSION  
OF KENTUCKY  
EFFECTIVE

7. Special Access Service (Cont'd)

7.2 Service Descriptions (Cont'd)

7.2.9 High Capacity Service (Cont'd)

(D) Optional Features and Functions (Cont'd)

(5) Enhanced Access Diversity (EAD)

MAY 23 1995

PURSUANT TO 807 KAR 5011,  
SECTION 9(1)

BY: Jordan C. Neal (N)  
FOR THE PUBLIC SERVICE COMMISSION

**EAD** is an optional feature in which Special Access High Capacity Service (MercNET 1.5 and MercNET 45) is provided on a transmission facility alternately routed from the primary (Standard) transmission facility path.

This feature utilizes existing physically diverse interoffice facilities, excluding equipment and facilities located in a wire center, to provide diversity between serving wire centers only.

**EAD** may be provisioned on Telephone Company facilities where capability and capacity exist. Otherwise, the customer may order facilities under Special Construction.

**When** placing orders for **EAD**, the customer **must** identify the services that will be diverse, and any facilities placed under Special Construction that will be used. The customer **must** also supply all appropriate facility assignments and other information to permit the Telephone Company to provide and maintain **EAD** service.

**When** High Capacity MercNET 45 service is multiplexed, rates and charges for each **EAD** service connecting to the multiplexer will apply. Applicable rates and charges for the MercNET 45 service will also apply if identified as an **EAD** service. Customers leasing Telephone Company-provided multiplexers will provide and identify Connecting Facility Assignments of diverse services to the multiplexer.

(N)

Issued: June 13, 1995

Effective: May 23, 1995

*Deborah D. Ditch*

President, Cincinnati, Ohio

Vice President  
Integrated Corporate Planning for

ACCESS SERVICE TARIFF  
 PSCK No. 2

CINCINNATI BELL TELEPHONE COMPANY

1st Revised Page 321  
 Cancels Original Page 321

7. Special Access Service (Cont'd)

7.2 Service Descriptions (Cont'd)

7.2.9 High Capacity Service (Cont'd)

(D) Optional Features and Functions (Cont'd)

The following table shows the technical specifications packages with which the optional features and functions are available.

|                              | Available with Technical Specifications Package HC- |          |           |          |          |          |
|------------------------------|---|----------|-----------|----------|----------|----------|
|                              | <u>0</u>  | <u>1</u> | <u>1C</u> | <u>2</u> | <u>3</u> | <u>4</u> |
| Central Office Multiplexing: |   |          |           |          |          |          |
| DS4 to DS1                   |   |          |           |          |          | X        |
| DS3 to DS1                   |   |          |           |          | X        |          |
| DS2 to DS1                   |   |          |           | X        |          |          |
| DS1C to DS1                  |   |          | X         |          |          |          |
| DS1 to Voice                 |   | X        |           |          |          |          |
| DS1 to DSO                   |   | X        |           |          |          |          |
| DSO to Subrate*              | X   |          |           |          |          |          |
| Clear Channel Capability     |   | X        |           |          |          |          |
| Enhanced Access Diversity    |   | X        |           |          | X        | (N)      |

PUBLIC SERVICE COMMISSION  
 OF KENTUCKY  
 EFFECTIVE

MAY 23 1995  
 PURSUANT TO 807 KAR 5.011,  
 SECTION 9(1)  
 BY: Jordan C. Neal  
 FOR THE PUBLIC SERVICE COMMISSION

\* Available only on a channel of a 1.544 Mbps facility to a Telephone Company hub.

Issued: June 13, 1995

Effective: May 23, 1995

*Deborah D. Nisch*  
 Vice President  
 Integrated Corporate Planning for  
 President, Cincinnati, Ohio

7. Special Access Service (Cont'd)

7.2 Service Descriptions (Cont'd)

7.2.10 Customer Network Reconfiguration Service (CNRS)\* (C)

(A) Basic Service Description

CNRS is an optional service for use with 1 544 Mbps (DS1) High Capacity Service and 9.6, 19.2, 56 and 64 kbps Digital Data Services and Voice Grade Service that enables a customer to monitor and reconfigure, in near real-time, their Special Access Service network without the intervention of the Telephone Company. The monitoring and reconfiguration functions are performed by a compatible customer-provided personal computer (PC) or other terminal device which is connected to a CNRS network controller, located in a Telephone Company CNRS hub. The PC or terminal device is connected to the CNRS network controller over an appropriate Special Access Service dedicated line or a local telephone line with a seven digit telephone number. The Telephone Company's CNRS hubs are designated in the National Exchange Carrier Association, Inc. Tariff F.C.C. No. 4. (C)

CNRS allows customers to perform network monitoring, circuit provisioning, bandwidth re-allocation, and circuit re-routing at the DS0 level within the CNRS hub equipment. Also, circuit rerouting may be performed at the DS1 level. Upon request, the Telephone Company will perform CNRS changes for the customer, subject to the charges specified in 7.5.9 following. Services that are cross-connected by CNRS must have identical technical characteristics to ensure compatibility and proper operation, e.g., Data to Data, Voice to Voice. CNRS specifications are delineated in Technical Reference TR-TSY000366.

CNRS provides the following functions:  
Network Monitoring and Surveillance

With compatible CPE equipment and software, users can Visually monitor the outgoing status of their network on their terminal.

\*CNRS is limited to existing subscribers of CNRS Service as of May 15, 1997 (C)

7. Special Access Service (Cont'd)

7.2 Service Descriptions (Cont'd)

7.2.10 Customer Network Reconfiguration Service (CNRS) (Cont'd)

(A) Basic Service Description (Cont'd)

Circuit Provisioning

Customers can activate or deactivate any of the circuits defined in the database down to the DSO level.

Manual and Automatic Route Selection

Customers can select alternate routes on demand, or on a pre-scheduled basis.

Bandwidth Re-allocation

Customers can shift unused bandwidth capacity to locations where it can be better utilized (e.g., temporary support for a videoconference).

Partitioning

For example, customers may choose to permit only a portion of their network to be accessible by CNRS or by certain personnel for security purposes.

Command Profiles Feature

Customers can set up files with pre-set lists of commands.

Reports and Alarms

Customers can obtain management reports regarding their network configuration, status, and various alarm reports.

Security

CNRS provides extensive multi-level security to deny unauthorized users access to a customer's CNRS network.

PUBLIC SERVICE COMMISSION  
OF KENTUCKY  
EFFECTIVE

MAR 3 1992

PURSUANT TO 807 KAR 5:011,  
SECTION 9(1)

Issued: February 7, 1992

Effective: March 3, 1992

*Robert E. Sigmon* for

President, Cincinnati, Ohio

PUBLIC SERVICE COMMISSION MANAGER

Vice President - Regulatory Affairs

7. Special Access Service (Cont'd)

7.2 Service Descriptions (Cont'd)

7.2.11 Reserved (T)

7.2.12 OC-3 Service, OC-12 Service, and OC-48 Service Point-to-Point Service (N)

(A) Basic Channel Description

(1) General

Point-to-Point OC-3, OC-12, and OC-48 channels provide high speed synchronous optical fiberbased full duplex data transmission capabilities. These services provide optical data transmission with the following characteristics:

- OC-3 Service provides channels operating at the terminating bit rate of 155.52 Mbps; and,
- OC-12 Service provides channels operating at the terminating bit rate of 622.08 Mbps.
- OC-48 Service provides channels operating at the terminating bit rate of 2488.32 Mbps.

OC-3, OC-12, and OC-48 channels may be used to connect:

- one customer-designated premise to another customer designated premise, either with or without the add/drop multiplexing capability at wire center locations between the two premises.
- a customer-designated premise to a Telephone Company location where add/drop multiplexing, add/drop functions and/or cross-connections are performed.

Optical Transmission paths for OC-3, OC-12, and OC-48 Services are differentiated by bit rate and the quality of transmission as delineated by the Optical Interface specified in established standard and technical publications.

OC-3, OC-12, and OC-48 Service may be connected by (1) using the appropriate OC-3, OC-12 or OC-48 add/drop multiplexer (mux) along with the add/drop function to a DS1 and/or DS3 at suitably equipped wire centers, or (2), by using the full bandwidth premise to premise.

(N)

7. Special Access Service (Cont'd)

7.2 Service Descriptions (Cont'd)

7.2.12 OC-3 Service, OC-12 Service, and OC-48 Service - Point-to-Point Service (Cont'd)

(N)

(A) Basic Channel Description (Cont'd)

(1) General (Cont'd)

OC-3 Service, OC-12 Service, and OC-48 Service based on customer requirements can be configured in any of the following ways:

OC-3 - three STS-1 (Synchronous Transport Signals) channels which each contain:

- one DS3 that is STS-1 mapped;
- up to 28 DS1s that are VT-mapped;
- an STS-1 channel without constraint to payload mapping when the STS-1 channel does not terminate via an add/drop function to DS1 or DS3 services within the CBT network;
- a single concatenated STS-3C channel.

OC-12 - twelve STS-1 channels which each contain:

- one DS3 that is STS-1 mapped;
- up to 28 DS1s that are VT-mapped;
- an STS-1 channel without constraint to payload mapping when the STS-1 channel does not terminate via an add/drop function to DS1 or DS3 services within the CBT network;
- four concatenated STS-3C channels;
- from one to three STS-3C channels mixed with from three to nine STS-1 channels subject to utilization of the total OC-12 capacity;

- a single concatenated STS-12C channel.

(N)

7. Special Access Service (Cont'd)

7.2 Service Descriptions (Cont'd)

7.2.12 OC-3 Service, OC-12 Service, and OC-48 Service - Point-to-Point Service (Cont'd)

(N)

(A) Basic Channel Description (Cont'd)

(1) General (Cont'd)

OC-48 - forty-eight STS-1 channels which each contain:

- one DS3 that is STS-1 mapped;
- up to 28 DS1s that are VT-mapped;
- an STS-1 channel without constraint to payload mapping when the STS-1 channel does not terminate via an add/drop function to DS1 or DS3 services within the CBT network;
- sixteen concatenated STS-3C channels
- from one to fifteen concatenated STS-3C channels, mixed with from three to forty-five STS-1 channels subject to utilization of the total OC-48 capacity;
- four concatenated STS-12C channels;
- from one to three concatenated STS-12C channels, mixed with from twelve to thirty-six STS-1 channels subject to utilization of the total OC-48 capacity;
- from one to three concatenated STS-12C channels, mixed with from four to twelve concatenated STS-3C channels, also mixed with from three to thirty-three STS-1 channels subject to utilization of the total OC-48 capacity.
- from one to three concatenated STS-12C channels, mixed with from one to eleven concatenated STS-3C channels, also mixed with from three to thirty-three STS-1 channels, subject to utilization of the total OC-48 capacity.

(N)



ACCESS SERVICE TARIFF  
PSCK No. 2

CINCINNATI BELL TELEPHONE COMPANY

Original Page 323.4

7. Special Access Service (Cont'd)

7.2 Service Descriptions (Cont'd)

7.2.12 OC-3 Service, OC-12 Service, and OC-48 Service - Point-to-Point Service (Cont'd)

(N)

(A) Basic Channel Description (Cont'd)

(1) General (Cont'd)

The customer is responsible via the ordering process to identify what STS signal configuration is to be contained in each OC-3, OC-12 and OC-48 service connection and each STS-1, STS-3, and/or STS-12 payload content. This information is needed for routing and connection purposes in the network

(B) Channel Configuration

(1) OC-3, OC-12 and OC-48 Channel Terminations

OC-3, OC-12 and OC-48 Channels consist of Channel Terminations (CTs), interoffice mileage and optional features and functions

OC-3, OC-12 and OC-48 Channel Terminations provide optical interconnection between the Telephone Company Serving Wire Center (SWC) and the customer premise.

(N)

7. Special Access Service (Cont'd)

7.2 Service Descriptions (Cont'd)

7.2.12 OC-3 Service, OC-12 Service, and OC-48 Service - Point-to-Point Service (Cont'd)

(N)

(B) Channel Configuration (Cont'd)

The following types of CTs are available

| Terminating Bit Rate | Loop Format* | Data Transmission Format |
|----------------------|--------------|--------------------------|
| 155.52 2             | fiber        | Synchronous              |
| 622.08 2             | fiber        | Synchronous              |
| 2488.322             | fiber        | Synchronous              |

When OC-3 Service, OC-12 Service and OC-48 Service is provided, the customer is responsible for providing Optical Line Termination (OLT) at the customer's premise. The OLT supplied at the customer premise must be compatible with the OLT used by the Telephone Company in the Serving Wire Center. The Telephone Company will work cooperatively with the customer to select compatible OLT which conform to the requirements set forth in established standard and technical publications.

(1) OC-3, OC-12 and OC-48 Channel Terminations

All CTs comprising a channel must have the same terminating bit rate unless multiplexing is performed at a Telephone Company Hub location.

(2) Channel Mileage

Channel Mileage facilities, comprised of Fixed and Per Mile as described in Section 7.1.2(B) preceding, provide the transmission paths between Serving Wire Centers associated with two customer-designated premises or between a Serving Wire Center associated with a customer premise and a Telephone Company Hub location. Three Channel Mileage types are available - OC-3 which supports bit rate of 155.52, OC-12 transport at the 622.08 bit rate and OC-48 transport at a bit rate of 2488.32.

(N)

\*Unidirectional Path Switched Rings

7. Special Access Service (Cont'd)

7.2 Service Descriptions (Cont'd)

7.2.12 OC-3 Service, OC-12 Service, and OC-48 Service - Point-to-Point Service (Cont'd)

(B) Channel Configuration (Cont'd)

(2) Channel Mileage (Cont'd)

OC-3 CTs are interconnected to OC-3 transport.  
OC-12 CTs are interconnected to OC-12 transport.  
OC-48 CTs are interconnected to OC-48 transport.

In addition, Channel Mileage can be connected between wire centers with Add/Drop multiplexing at a lower OC-N speed than the CT, if the transport is between a lower speed Add/Drop Function and:

- another lower speed Add/Drop Function;
- another lower speed Channel Termination-;
- a lower speed Dedicated Ring Port;
- a lower speed Cross-Connect.

All of the above terminations must be the same speed as the Channel Mileage.

(3) Optional Features and Functions

The following optional features and functions are available: Add/Drop Multiplexing, Add/ Drop Function. OC-3, OC-12 and OC-48 Cross-Connection, 1+1 Protection with Route Survivability, 1+1 Protection with Central Office Survivability, and OC-48 Regenerator.

(a) OC-3, OC-12 and OC-48 Add/Drop Multiplexing

An arrangement that allows an OC-3, OC-12 or OC-48 channel operating at a terminating speed of 155.52 Mbps, 622.08 Mbps and 2488.32 Mbps respectively, to add/drop a lower speed channel by using this feature along with the add/drop function as stated in (b) following.

ACCESS SERVICE TARIFF  
PSC No. 2

CINCINNATI BELL TELEPHONE COMPANY

Original Page 323.7

7. Special Access Service (Cont'd)

7.2 Service Descriptions (Cont'd)

7.2.12 OC-3 Service, OC-12 Service, and OC-48 Service - Point-to-Point Service (Cont'd)

(B) Channel Configuration (Cont'd)

(3) Optional Features and Functions (Cont'd)

(a) OC-3, OC-12 and OC-48 Add/Drop Multiplexing (Cont'd)

OC-3 add/drop multiplexing at a Telephone Company wire center will provide the capability to support the full add/drop function capacity of OC-3 Service bandwidth with up to three DS3 add/drop functions or equivalently up to three groups of 28 DS1 add/drop functions.

OC-12 add/drop multiplexing at a Telephone Company wire center will provide the capability to support the full add/drop function capacity of OC-12 service bandwidth with up to four OC-3 add/drop functions or up to 12 DS3 add/drop functions or equivalent combinations of OC-3 and DS3 add/drop functions.

OC-48 add/drop multiplexing at a Telephone Company wire center will provide the capability to support one quarter of the add/drop function capacity of OC-48 service bandwidth. Up to four OC-48 add/drop multiplexing options may be provided with each supporting one OC-12 add/drop function, or up to four OC-3 add/drop functions or up to 12 DS3 add/drop functions or equivalent combination of OC-3 and DS3 add/drop functions.

(N)

(N)

7. Special Access Service (Cont'd)

7.2 Service Descriptions (Cont'd)

7.2.12 OC-3 Service, OC-12 Service, and OC-48 Service - Point-to-Point Service (Cont'd)

(N)

(B) Channel Configuration (Cont'd)

(3) Optional Features and Functions (Cont'd)

(b) Add/Drop Function

The OC-3 Service, OC-12 Service and OC-48 Service are able to add or drop lower level signals as shown in the matrix following. The add/drop function is offered at a circuit level. For example, if a customer wants to drop one DS3 signal from an OC-12 service, they would pay one add/drop charge for the DS3, plus the OC-12 add/drop multiplexing charge.

The OC-3, OC-12 and OC-48 Service is only able to add/or drop the services that have been identified by payload content (mapping) within the bandwidth. DS1 mapped STS-1 signals are only able to connect to an DS1, and DS3 mapped STS-1 signals are only able to connect to a DS3. If a change is required, it may be accomplished by the customer's CPE or through the current asynchronous environment for multiplexing of DS3 and DS1 services stated in Section 7.2.9.

The options in (a) and (b) above cannot be used with OC-3 or OC-12 Service configured by the customer to contain a single nonchannelized (concatenated) STS-3C or STS-12C signal, respectively.

(N)

7. Special Access Service (Cont'd)

7.2 Service Descriptions (Cont'd)

7.2.12 OC-3 Service, OC-12 Service, and OC-48 Service - Point-to-Point Service (Cont'd)

(N)

(B) Channel Configuration (Cont'd)

(3) Optional Features and Functions (Cont'd)

ADD/DROP Function

|       | DS1 | DS3 | OC3 | OC12 |
|-------|-----|-----|-----|------|
| OC-48 | No* | Yes | Yes | Yes  |
| OC-12 | NO* | Yes | Yes | N/A  |
| OC-3  | Yes | Yes | N/A | N/A  |

\* to add/drop a DS1 from an OC-12 and/or OC-48, an inter-mediate step at either OC-3 or DS3 must be taken.

(c) OC-3, OC-12 and OC-48 Cross-Connection

This is an arrangement to cross-connect OC-3 Service, OC-12 Service or OC-48 Service to another service or to an add/drop function of the same speed at a wire center for the same or for a different customer on a per circuit basis. The customer must purchase service to the wire center from his designated premise. One charge applies per service cross-connected

(N)

7. Special Access Service (Cont'd)

7.2 Service Descriptions (Cont'd)

7.2.12 OC-3 Service, OC-12 Service, and OC-48 Service - Point-to-Point Service (Cont'd)

(N)

(B) Channel Configuration (Cont'd)

(3) Optional Features and Functions (Cont'd)

(d) 1+1 Protection with Route Survivability

This option will provide 1+1 protection and offer additional protection from fiber cable cuts by routing the working fiber pair via the primary route and the protect fiber pair via a physically diverse alternate route. The protect fiber will be charged on a distance-sensitive basis, based on quarter route miles, from the customer premise to the serving wire center.

This option will also provide 50 millisecond protection switching to assure 100 percent availability of the service. Any service interruption will result in a credit equal to one month's bill for the circuit involved. If the interruption occurs on a Channel Termination without this option, normal terms and conditions for out-of-service credits as stated in 2.4.4 preceding will apply. An interruption period will start when an inoperative service is reported to the Telephone Company and end when the service is operative. In any month, as a result of an interruption, the total credit per rate element of the interrupted service may not exceed 100 percent of the monthly charge for that particular rate element. All other terms and conditions for Credit Allowances as stated in 2.4.4 preceding, will apply.

Installation of the 1+1 Protection with Route Survivability option will not begin until the customer has accepted the proposed routing by the Telephone Company.

(N)

7. Special Access Service (Cont'd)

7.2 Service Descriptions (Cont'd)

7.2.11 OC-3 Service, OC-12 Service, and OC-48 Service - Point-to-Point Service (Cont'd)

(B) Channel Configuration (Cont'd)

(3) Optional Features and Functions (Cont'd)

(e) 1+1 Protection with Central Office Survivability for OC-3, OC-12 and OC-48 (Cont'd)

Installation of the 1+1 Protection with Central Office Survivability option will not begin until the customer has accepted the proposed routing by the Telephone Company.

If the customer wants to use this optional feature as a ring extension with OC-12 or OC-48 Dedicated Ring Service, then both the customer's Serving Wire Center and alternate wire center must have Nodes located on the ring. The Telephone Company will work cooperatively with the customer to determine the appropriate alternate wire center to be used for the Dedicated Ring situation. Channel Mileage will not apply to this option when used with a ring extension.

(N)

(N)



7. Special Access Service (Cont'd)

7.2 Service Descriptions (Cont'd)

7.2.12 OC-3 Service, OC-12 Service, and OC-48 Service - Point-to-Point Service (Cont'd)

(B) Channel Configuration (Cont'd)

(3) Optional Features and Functions (Cont'd)

(f) OC-48 Regenerator

Regenerators provide essential detection and retransmission of SONET Optical signals between customer premises. Regenerators will only be provided as required by the Telephone Company actual fiber facility distances between customer-designated premise and/or central office locations exceed design limits (typically 18 to 25 miles). Regenerators will be located exclusively in Telephone Company central offices.

The following diagrams provide an example of (d) and (e) above:

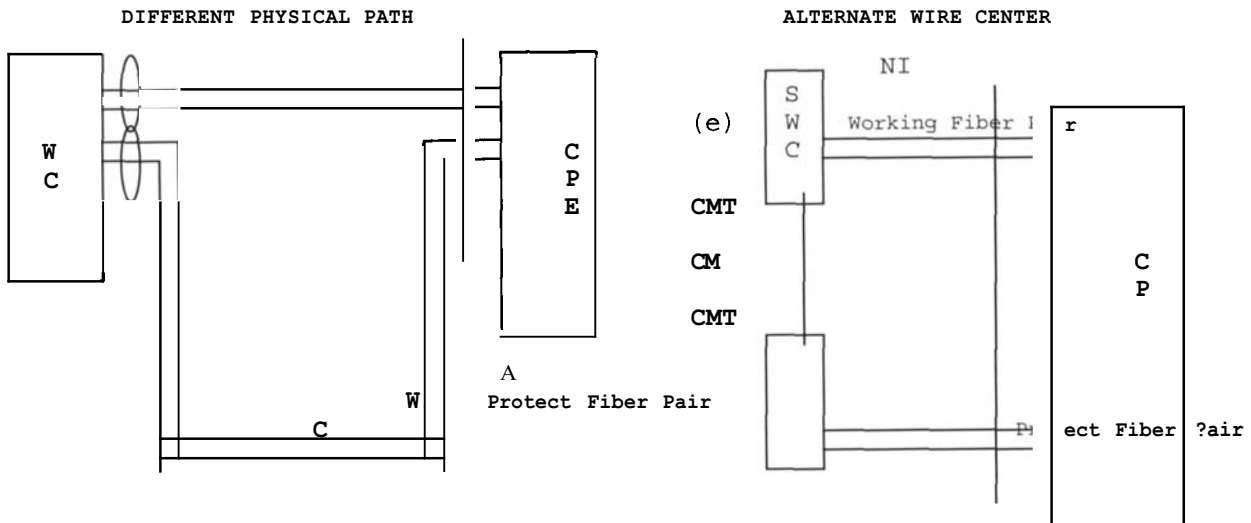

\*CM = Channel Mileage  
 \*CMT = Channel Mileage Terminations

7. Special Access Service (Cont'd)

7.2 Service Descriptions (Cont'd)

7.2.13 OC-3 Service, OC-12 Service, and OC-48 Service-Dedicated Ring

(N)

(A) Basic Service Description

(1) General

OC-3, OC-12, and OC-48 Dedicated Ring Service operates at the same speeds as Point-to-point Services, however, the Dedicated Ring Service provides a customer a dedicated custom network. The network is in a ring architecture designed to provide increased reliability and functionality connecting multiple customer-designated locations and specified Telephone Company Central Offices (COs) via self-healing network designs. Dedicated Ring Service will provide 50 millisecond protection switching to assure 100 percent availability of the services on the ring. Dedicated Ring Service is provided where appropriate SONET facilities are available. Where facilities are not available, Special Construction may apply.

Dedicated Ring Service is an alternative to OC-3, OC-12 and OC-48 point-to-point service between multiple customer locations. Rate elements include nodes, ports, mileage between nodes, regenerators, Optical to Electrical DS1 add/drop capability and Optical OC-48 add/drop capability. Rates are specified in 7.5.12 following.

Existing customers with Point-to-point OC-3, OC-12 and OC-48 may upgrade to Dedicated Ring Service without termination liability.

A service interruption will result in a credit equal to one month's bill for the individual port-to-port connection involved. An interruption of service will start when an inoperative service is reported to the Telephone Company and end when the service is operative. In any month, as a result of an interruption, the total credit per rate element of the interrupted service may not exceed 100 percent of the monthly charge for that particular rate element.

(N)

7. Special Access Service (Cont'd)

7.2 Service Descriptions (Cont'd)

7.2.13 OC-3 Service, OC-12 Service, and OC-48 Service Dedicated Ring (Cont'd)

(N)

(B) Dedicated Ring Configuration

(1) Nodes

The ring will provide connectivity to multiple customer-designated locations (nodes). However, a ring must have a minimum of three nodes. At least one node must be a Telephone Company CO and one must be a customer premise. A maximum of 16 nodes, including regenerators, will be allowed per ring.

The Telephone Company reserves the right to determine the order of the nodes on the ring.

When a customer premise node is located in the same building as a CO node, there will be no diversity between the two nodes.

The customer will be billed time and material for any additional charges incurred by the Telephone Company in locating Company equipment at the customer premise.

(2) OC-48 Add/Drop Capability

This provides the capability to add/drop lower speed channels from an OC-48 Dedicated Ring node location via OC-12, OC-3, or DS3 ports. OC-48 Add/Drop Capability at an OC-48 Dedicated Ring Service node location will support one quarter of the port capability of OC-48 ring bandwidth. Up to four OC-48 Add/Drop Capability options may be provided at a node with each option supporting one OC-12 port, up to four OC-3 ports, up to twelve DS3 ports, or an equivalent combination of OC-3 and DS3 ports.

(N)

7. Special Access Service (Cont'd)  
7.2 Service Descriptions (Cont'd)

7.2.13 OC-3 Service, OC-12 Service, and OC-48 Service Dedicated Ring (Cont'd)

(N)

(B) Dedicated Ring Configuration (Cont'd)

(3) Ports

The ring capacity will be either OC-3, OC-12 or 48-OC  
Lower speed channels are accessible at nodes  
via port terminations.

Accepted interfaces are as follows:

| OC-3 Node                  | OC-12 Node            | OC-48 Node             |
|----------------------------|-----------------------|------------------------|
| DS1 Ports X (Max. 84/Node) | X*(Max. 84/OC-3 Port) | X* (Max. 84/OC-3 Port) |
| DS3 Ports X (Max.3/Node)   | X (Max. 12/Node)      | X (Max. 48/Node)       |
| **OC-3 Ports N/A           | X (Max. 4/Node)       | X (Max. 16/Node)       |
| OC-12 Ports N/A            | N/A                   | X (Max. 4/Node)        |

OC-3 Point-to-Point service may connect to an OC-3 port of an OC-12 or OC-48 ring or OC-12 Point-to-Point service may connect to an OC-12 port of an OC-48 ring located in a Company CO.

As described in Section 7.2.12A for OC-3 Service, an OC-3 port will permit the connection of STS-1 channels to other STS-1 channels across the OC-12 or OC-48 Dedicated Ring Service subject to the overall ring capacity limits described in (6) following. Also, an STS-1 channel with DS1 payload mapping accessing an OC-12 Dedicated Ring using an OC-3 port may be connected to the Optical to Electrical DS1 add/drop capability for the purpose of connecting up to 28 DS1 ports. An STS-1 channel with DS3 payload mapping accessing the OC-12 or OC-48 Dedicated Ring using an OC-3 port may individually connect to a DS3 port.

DS1 ports, DS3 ports and STS-1 channels within OC-3 ports may not connect to any other ports within the same node. All other port-to-port connections are allowable except for DS3 port to DS1 port connections. If a DS3 to DS1 connection is required, it may be accomplished by the customer's CPE or through the current multiplexing environment of DS3 and DS1 Services described in Section 7.2.9.

\* Optical to Electrical DS1 add/drop capability as shown in 7.2.13(B)(4) is needed along with an OC-3 Port.

\*\* Number of interfaces on Nodes equipped for multiplexing may vary.

(N)

7. Special Access Service (Cont'd)

7.2 Service Descriptions (Cont'd)

7.2.13 OC-3 Service, OC-12 Service, and OC-48 Service Dedicated Ring (Cont'd)

(N)

(B) Dedicated Ring Configuration (Cont'd)

(4) Mileage

Mileage is the total airline distance between the serving wire center of each node involved on the ring. A one mile minimum will be billed between nodes.

In addition, interoffice transport may be connected between wire centers at a lower OC-N speed than the Dedicated Ring, if the transport is between a dedicated ring port and

- a lower speed Add/Drop Function;
- a lower speed Channel Termination;
- another lower speed Dedicated Ring Port;
- a lower speed Cross-Connect;

All of the above terminations must be the same speed as the transport.

(5) Optical to Electrical DS1 Add/Drop Capability

This option allows an electrical DS1 to be derived from an optical OC-12 or OC-48 ring by using this capability to add/drop the electrical DS1 from an OC-3 port.

(N)

7. Special Access Service (Cont'd)

7.2 Service Descriptions (Cont'd)

(N)

7.2.12 OC-3 Service, OC-12 Service, and OC-48 Service Dedicated Ring (Cont'd)

(B) Dedicated Ring Configuration (Cont'd)

(6) Dedicated Ring Regenerator

Regenerators provide essential detection and retransmission of SONET Optical 155.52 Mbps, 622.08 Mbps and 2488.32 Mbps signals between nodes. Regenerators will only be provided as required by the Telephone Company when actual fiber facility distances between customer-designated nodes exceed inter-nodal design limits (typically 18 to 25 miles). Regenerators will be located exclusively in Telephone Company COs and do not allow ports to access customer service connections.

(7) Dedicated Ring Connection capacity

Maximum transport capacity of OC-3, OC-12 and OC-48 Dedicated Ring Service is characterized by the total quantity of individual port-to-port connections allowed between all nodes on the ring.

(N)

ACCESS SERVICE TARIFF  
PSCK No. 2

CINCINNATI BELL TELEPHONE COMPANY

Original Page 323.19

7. Special Access Service (Cont'd)

7.2 Service Descriptions (Cont'd)

7.2.13 OC-3 Service, OC-12 Service, and OC-48 Service Dedicated Ring (Cont'd)

(N)

(B) Dedicated Ring Configuration (Cont'd)

(7) Dedicated Ring Connection Capacity (Cont'd)

For OC-3 Dedicated Ring Service, the maximum ring capacity will be equal to one of the following combinations:

| <b>DS3 Port to US3<br/>Port Connections</b> | <b>DS1 Port to DS1<br/>Port Connections</b> |
|---|---|
| <b>Three and</b>                            | <b>None</b>                                 |
| <b>Two and</b>                              | <b>Up to 28</b>                             |
| <b>One and</b>                              | <b>Up to 56</b>                             |
| <b>None and</b>                             | <b>Up to 84</b>                             |

(N)

7. Special Access Service (Cont'd)

7.2 Service Descriptions (Cont'd)

7.2.13 OC-3 Service, OC-12 Service, and OC-48 Service Dedicated Ring (Cont'd)

(N)

(B) Dedicated Ring Configuration (Cont'd)

(7) Dedicated Ring Connection Capacity (Cont'd)

For OC-12 Dedicated Ring Service, the maximum ring capacity will be equal to one of the following combinations:

| DS3 Port Connections | DS1 Port Connections | Port Connections        |
|----------------------|----------------------|-------------------------|
| Twelve               | and                  | None                    |
| Eleven               | and                  | One group of 28         |
| Ten                  | and                  | Two Groups of 28 (56)   |
| Nine                 | and                  | Three groups of 28 (84) |
| Eight                | and                  | Four Groups of 28 (112) |
| Seven                | and                  | Five Groups of 28 (140) |

|                                    |
|------------------------------------|
| Six Groups of 28 (156)             |
| Five and Seven Groups of 28 (196)  |
| Four and Eight Groups of 28 (224)  |
| Three and Nine Groups of 28 (252)  |
| Two and Ten Groups of 28 (280)     |
| One and Eleven Groups of 28 (306)  |
| None and Twelve Groups of 28 (336) |

DS3

For OC-12 Dedicated Ring Service, individual DS1 port-to-DS1 port connection capacities may be distributed only in incremental groups of 28 between any two nodes on the ring. Individual DS3 port-to-DS3 port connection capacities may be incrementally distributed between nodes on the ring in any manner.

OC-12 Dedicated Ring Service will also provide capability for node-to-node connection of STS-1 or STS-3C channels using OC-3 ports on the OC-12 ring. Each STS-1 to STS-1 channel connection will reduce the remaining ring capacity by the equivalent of one DS3 port-to-DS3 port connection or 28 DS1 port-to-DS1 port connections. Each STS-3C to STS-3C channel connection requested by the customer will reduce the remaining ring capacity by the equivalent of three DS3 port-to-DS3 port connections or 84 DS1 port-to-port connections.



ACCESS SERVICE TARIFF  
 PSCK No. 2

CINCINNATI BELL TELEPHONE COMPANY

Original Page 323.21

7. Special Access Service (Cont'd)

7.2 Service Descriptions (Cont'd)

7.2.13 OC-3 Service, OC-12 Service, and OC-48 Service Dedicated Ring (Cont'd)

(B) Dedicated Ring Configuration (Cont'd)

(7) Dedicated Ring Connection Capacity (Cont'd)

For OC-48 Dedicated Ring Service, the maximum ring capacity will be equal to one of the following combinations:

| DS3 Port to DS3<br>Port Connections | DS1 Port to DS1<br>Port Connections | DS3 Port to<br>Port Connections   | DS1 Port to DS1<br>Port Connections |
|-------------------------------------|-------------------------------------|---|-------------------------------------|
| Forty-eight and                     | None                                | Forty-one and   | Seven Groups of 28 (196)            |
| Forty-seven and                     | One Group of 28                     | Forty and   | Eight Groups of 28 (224)            |
| Forty-six and                       | Two Groups of 28 (56)               | Thirty-nine and   | Nine Groups of 28 (252)             |
| Forty-five and                      | Three Groups of 28 (84)             | Thirty-eight and  | Ten Groups of 28 (280)              |
| Forty-four and                      | Four Groups of 28 (112)             | Thirty-seven and  | Eleven Groups of 28 (308)           |
| Forty-three and                     | Five Groups of 28 (140)             | Thirty-six and  | Twelve groups of 28 (336)           |
| Forty-two and                       | Six Groups of 28 (168)              | Continuing down the scale to:<br>None and Forty-eight Groups of 28 (1344) |                                     |

(N)

(N)

ACCESS SERVICE TARIFF  
PSC No. 2

CINCINNATI BELL TELEPHONE COMPANY

Original Page 323.22

7. Special Access Service (Cont'd)

7.2 Service Descriptions (Cont'd)

7.2.13 OC-3 Service, OC-12 Service, and OC-48 Service Dedicated Ring (Cont'd)

(N)

(B) Dedicated Ring Configuration (Cont'd)

(7) Dedicated Ring Connection Capacity (Cont'd)

For OC-48 Dedicated Ring Service, individual DS1 port-to-DS1 port connection capacities may be distributed only in incremental groups of 28 between any two nodes on the ring. Individual DS3 port-to-DS3 port connection capacities may be incrementally distributed between nodes on the ring in any manner.

OC-48 Dedicated Ring Service will also provide capability for node-to-node connection of STS-1 or STS-3C channels using OC-3 or OC-12 ports on the OC-48 ring. Each STS-1 to STS-1 channel connection or STS-1 channel to DS3 port connection requested by the customer will reduce the remaining ring capacity by the equivalent of one DS3 port-to-port connection or 28 DS1 port-to-port connections. Each STS-3C to STS-3C channel connection requested by the customer will reduce the remaining ring capacity by the equivalent of three DS3 port-to-DS3 port connections or 84 DS1 port-to-port connections.

OC-48 Dedicated Ring Service will also provide capability for node-to-node connections of STS-12C channels using OC-12 ports on the OC-48 ring. Each STS-12C to STS-12C channel connection requested by the customer will reduce the remaining ring capacity by the equivalent of twelve DS3 port-to-DS3 port connections or 336 DS1-to-DS1 port connections.

(N)

7. Special Access Service (Cont'd)

7.2 Service Descriptions (Cont'd)

7.2.13 OC-3 Service, OC-12 Service, and OC-48 Service Dedicated Ring (Cont'd)

(B) Dedicated Ring Configuration (Cont'd)

(8) Diagram OC-3, OC-12 and OC-48 Ring

CBT OC-3 Dedicated Ring Service

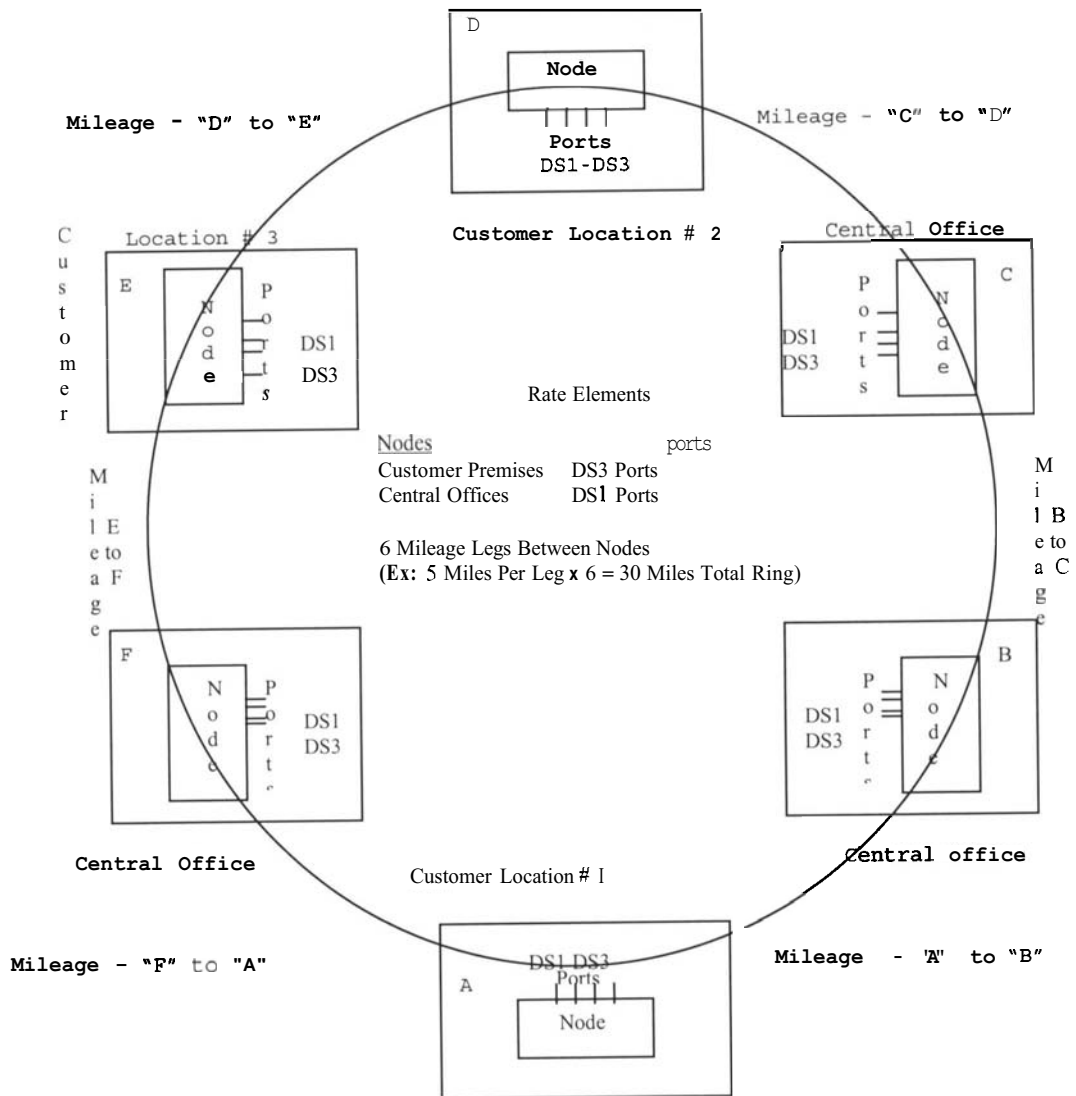

(N)

7. Special Access Service (Cont'd)

7.2 Service Descriptions (Cont'd)

7.2.13 OC-3 Service, OC-12 Service, and OC-48 Service Dedicated Ring (Cont'd)

(B) Dedicated Ring Configuration (Cont'd)

(8) Diagram OC-3, OC-12 and OC-48 Ring (Cont'd)

OC-12 Dedicated Ring Service

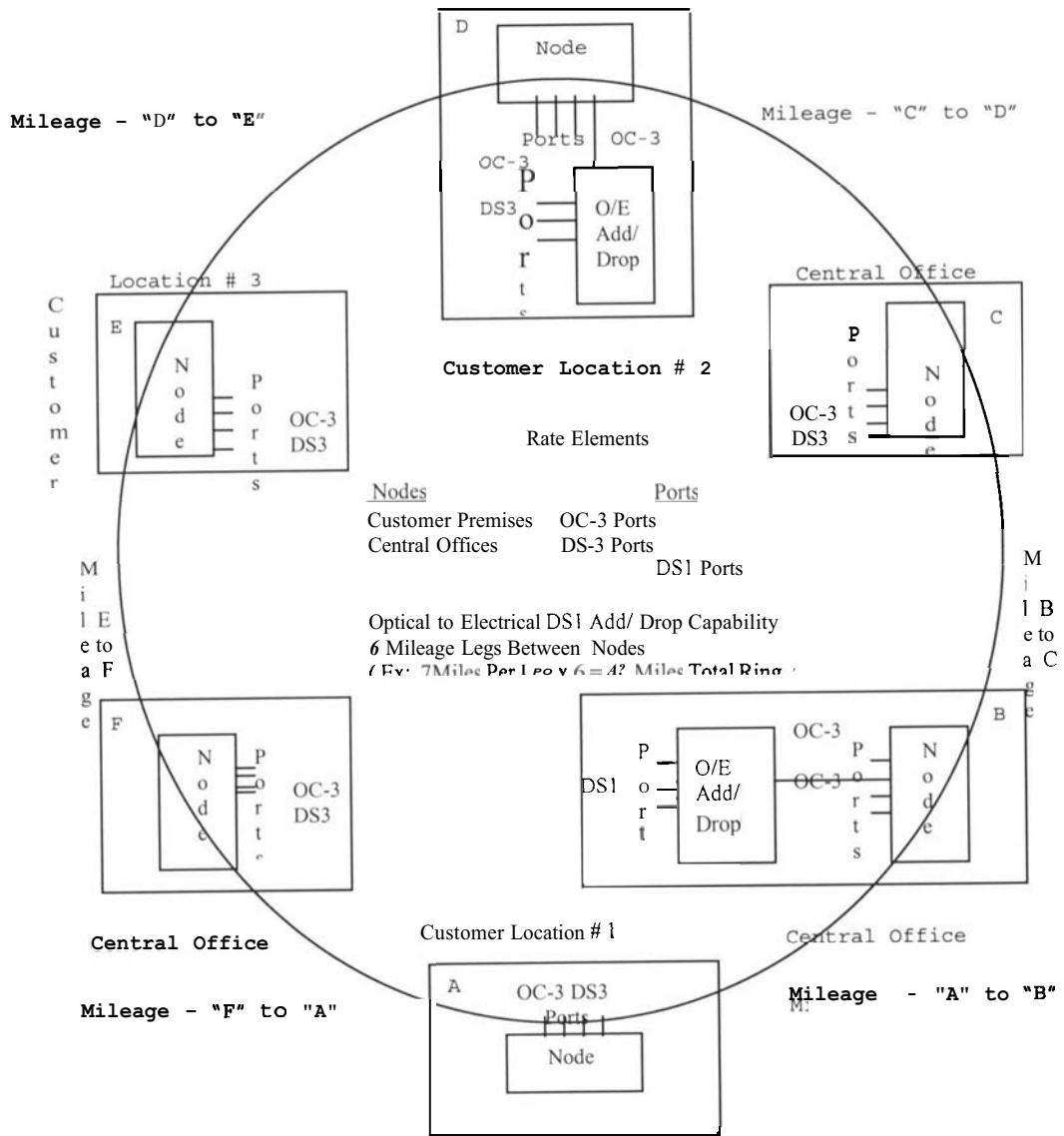

(N)

Issued: February 23, 1999

Effective: January 25, 1999

President, Cincinnati, Ohio

(N)

7. Special Access Service (Cont'd)  
7.2 Service Descriptions (Cont'd)

7.2.13 OC-3 Service, OC-12 Service, and OC-48 Service Dedicated Ring (Cont'd)

(B) Dedicated Ring Configuration (Cont'd)

(8) Diagram OC-3, OC-12 and OC-48 Ring (Cont'd)

**CBT OC-48 Dedicated Ring Service**

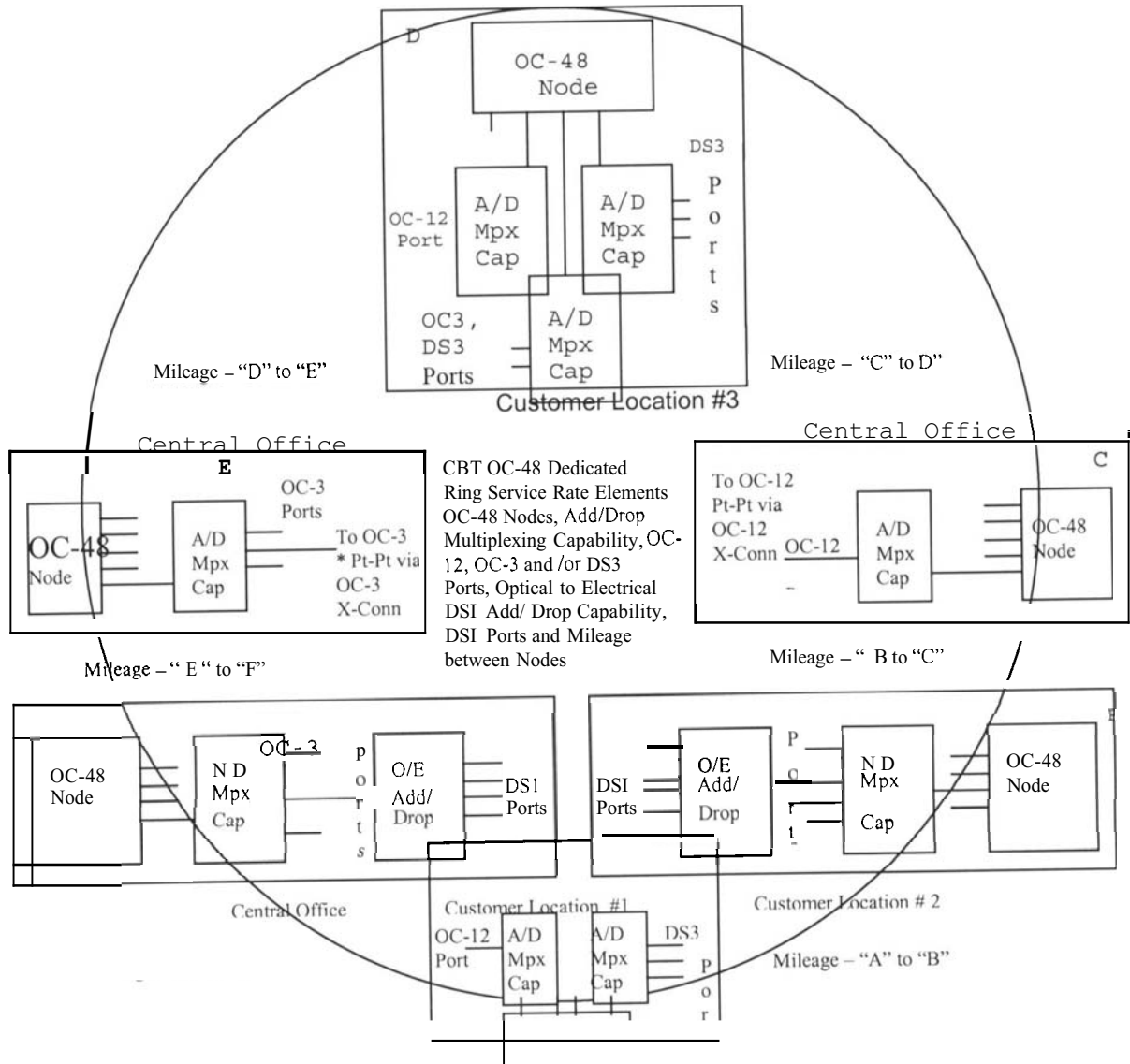

ACCESS SERVICE TARIFF  
PSC No. 2

CINCINNATI BELL TELEPHONE COMPANY

Original Page 323.26

7. Special Access Service (Cont'd)

7.2 Service Descriptions (Cont'd)

7.2.13 OC-3 Service, OC-12 Service, and OC-48 Service Dedicated Ring  
(Cont'd)

(N)

(B) Dedicated Ring Configuration (Cont'd)

(9) Optional Payment Period

Dedicated Rings are available for either 36 month or 60 month periods. Monthly recurring charges apply for the nodes, ports and mileage between nodes. If a node is added after the initial installation of the dedicated ring, the new node will carry the same OPP rate as the initial ring and be conterminous with that OPP. However, if a node is added during the last 12 months or less of an OPP, the customer will be billed the initial OPP ring rate for a minimum period of 12 months.

Logical changes in the ring (change in mapping content) are not considered to be a dedicated ring termination, however, any physical change would be considered a termination and all appropriate termination liability would apply as specified in paragraph 7.4.9 following. Also, all other rate regulations pertaining to OPP would apply. See Section 7.4.9 following.

(N)

ACCESS SERVICE TARIFF  
PSC No. 2

CINCINNATI BELL TELEPHONE COMPANY

Original Page 323.27

7. Special Access Service (Cont'd)

7.2 Service Descriptions (Cont'd)

7.2.14 Shared SONET Service

(N)

A. Basic Service Description

Shared SONET service is a shared ring service which provides high performance and reliability parameters with the level of survivability designed to limit a single event from interrupting service. It provides route, central office equipment, and signal payload protection for point-to-point DS1 and DS3 channels provisioned on the shared ring. No additional optional features are required for this level of protection. It provides flat rate transport across the network of DS1, DS3, OC-3 and OC-12 (VT1.5 and STS-1) channels. Shared SONET utilizes SONET facilities and is available only in buildings and wire centers (Shared SONET Network) where the Telephone Company has established shared rings.

For locations where Shared SONET is not yet available Special Construction charges may apply. Expansion of service areas by means of Special Construction will only be allowed in designated areas consistent with the Telephone Company's construction program. Shared SONET service areas are designated in National Exchange Carrier Association Tariff F.C.C. No. 4.

Shared SONET service must be specifically ordered even if a customer premises or serving wire center is located in the designated Shared SONET serving area.

Shared SONET will provide 50 millisecond protection switching to assure 100 percent availability of the end-to-end services within the network. When a customer's end-to-end service utilizes both the Shared SONET network and non Shared SONET network, the non-Shared SONET network portion will have the appropriate service guarantees as specified in Section 2.4.4 preceding.

Shared SONET Service is excluded from any application of Shared

7. Special Access Service (Cont'd)

7.2 Service Descriptions (Cont'd)

7.2.14 Shared SONET Service (Cont'd)

(N)

B. Channel Configuration

(1) Network Access Connection (NAC)

The Network Access Connection provides SONET based access to the Shared SONFR shared transport network. NACs are available with electrical 1.544 Mbps (DS1) and 44.736 Mbps (DS3) interfaces only. The NAC is applicable when the customer's premises is located in a building on the Shared SONET network.

(2) Off-Network Access Connection (ONAC)

The Off-Network Access Connection provides a SONET based connection to the Shared SONET transport network at a company-designated Shared SONET central office. ONACs are available with electrical 1.544 Mbps (DS1), 44.736 Mbps (DS3) as well as protected optical OC-3 and OC-12 interfaces. The ONAC is applicable when the customer's premises is not located in @ building on the Shared SONET network.

In addition to the ONAC charge, the customer is responsible for the appropriate Local Distribution Channel Charge (and Channel Mileage and Channel Mileage Termination charges, if appropriate) from the customer premises to the ONAC location on the network.

(3) DS3 Payload Multiplexing Function (PMF)

DS3 Payload Multiplexing Function provides the capability to multiplex up to 28 DS1 channels or 28 VT 1.5 channels with DS1 payload mapping to or from a specific

(I)



ACCESS SERVICE TARIFF  
PSC No. 2

CINCINNATI BELL TELEPHONE COMPANY

Original Page 323.29

7. Special Access Service (Cont'd)

7.2 Service Descriptions (Cont'd)

7.2.14 Shared SONET Service (Cont'd)

(N)

B. Channel Configuration (Cont'd)

(3) (Cont'd)

DS3 channel or an STS-1 channel with DS3 payload mapping at a location determined by the Telephone Company within the Shared SONET Network. Customers can continue to maintain existing DS1 to DS3 traffic relationships while using Shared SONET access connections and banded transport. DS1 channels from across the serving area can be assigned to a specific DS3 channel for transport to a customer premises and/or a central office location. This option is only available when a DS1/VT1.5 is mapped or delivered to a DS3/STS-1 channel.

(4) Service Area Transport (SAT)

Service Area Transport provides SONET transport across the Shared SONET network. The transport is divided into three mileage bands: a) up to 3 miles, b) greater than 3 miles and up to 10 miles, and c) greater than 10 miles. Transport charges are based on the airline miles between a) the serving wire centers of two NACS, the serving wire centers of a NAC and an ONAC location or c) serving wire centers of two ONAC locations. SAT is available as DS1/VT1.5 point to point, DS3/STS-1 point to point or DS3, OC-3 or OC-12 channelized SAT provided on a per DS1/VT1.5 basis.

(N)

7. Special Access Service (Cont'd)

7.2 Service Descriptions (Cont'd)

7.2.14 Shared SONET Service (Cont'd)

B. Channel Configuration (Cont'd)

(4) (Cont'd)

The following is an example of the Shared SONET rate elements :

Shared SONET Transport Services

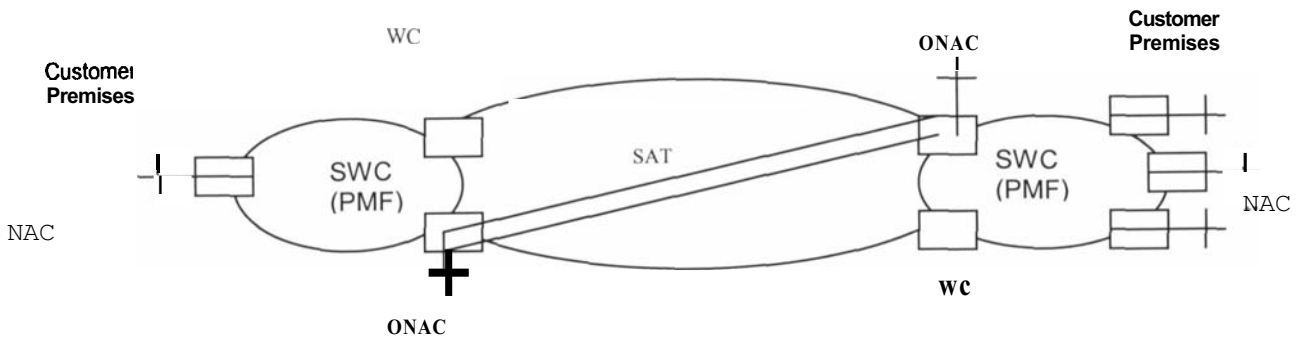

- NAC** - DS1 or DS3 Network Access Connection
- ONAC** - DS1, DS3, or OC-12 Off- Network Access Connection
- SAT** - DS1/VT1.5 or DS3/STS-1 Service Area Transport
- PMF** - DS3 Payload Multiplexing Function (if applicable)
- SWC** - Serving Wire Center
- WC** --Wire Center

(N)

(N)

ACCESS SERVICE TARIFF  
PSC No. 2

CINCINNATI BELL TELEPHONE COMPANY

Original Page 323.31

7. Special Access Service (Cont'd)

7.2 Service Descriptions (Cont'd)

7.2.14 Shared SONET Service (Cont'd)

(N)

B. Channel Configuration (Cont'd)

(5) Technical Specifications Packages

The technical specifications for Shared SONET Service are described in established standard and technical publications.

C. Optional Payment Plan (OPP)

Shared SONET Service is available for 36 or 60 month periods as described in section 7.4.9 following. Monthly recurring charges apply for NAC, ONAC, SAT and PMF, if applicable.

(N)

ACCESS SERVICE TARIFF  
PSCK No. 2

CINCINNATI BELL TELEPHONE COMPANY

Original Page 324

7. Special Access Service (Cont'd)

7.3 Reserved

7.4 Rate Regulations

This section contains the specific regulations governing the rates and charges that apply for Special Access Service.

PUBLIC SERVICE COMMISSION  
OF KENTUCKY  
EFFECTIVE

MAR 3 1992

PURSUANT TO 807 KAR 5:011

Issued: February 7, 1992

Effective: <sup>SECTION 9(1)</sup> March 3, 1992  
BY: *[Signature]*  
PUBLIC SERVICE COMMISSION MANAGER

*Robert E. Aigmon* for President, Cincinnati, Ohio

Vice President - Regulatory Affairs

ACCESS SERVICE TARIFF  
PSCK No. 2

CINCINNATI BELL TELEPHONE COMPANY

1st Revised Page 325  
Cancels Original Page 325

7. Special Access Service (Cont'd)

7.4 Rate Regulations (Cont'd)

7.4.1 Types of Rates and Charges

There are three types of rates and charges. These are monthly rates, daily rates and nonrecurring charges. The rates and charges are described as follows:

(A) Monthly Rates

Monthly rates are flat recurring rates that apply each month or fraction thereof that a Special Access Service is provided. For billing purposes, each month is considered to have 30 days.

For Channel Terminations associated with MercNET 45 High Capacity Service there are higher monthly rates for the first channel termination and lower monthly rates for the **second**, third and above channel terminations provided when the following conditions are met:

- The first, second, and third and above service(s) are billed to the same customer.
- The first, second, and third and above service(s) must be provided to the same customer premises.
- Each subsequent order for a channel termination is eligible for the appropriate lower monthly rate.

PUBLIC SERVICE COMMISSION  
OF KENTUCKY  
EFFECTIVE

MAY 23 1995

PURSUANT TO 807 KAR 5011.  
SECTION 9(1)

BY: Jordan C. Neal  
FOR THE PUBLIC SERVICE COMMISSION

For **Channel Terminations** associated with MercNET 45 High Capacity Service - 12 Pack Arrangement the **following** conditions must be met:

- The 12 pack arrangement must be billed to the same customer.
- **The** 12 pack arrangement must be **provided** to the same premises.

(N)  
|  
(N)

Issued: June 13, 1995

Effective: May 23, 1995

Deborah A. Nisch President, Cincinnati, Ohio  
Vice President  
Integrated Corporate Planning for

ACCESS SERVICE TARIFF  
PSCK No. 2

CINCINNATI BELL TELEPHONE COMPANY

Original Page 326

7. Special Access Service (Cont'd)

7.4 Rate Regulations (Cont'd)

7.4.1 Types of Rates and Charges (Cont'd)

(B) Daily Rates

Daily rates are flat recurring rates that apply to each 24 hour period or fraction thereof that a Program Audio Special Access Service is provided for part-time or occasional use. For purposes of applying daily rates, the 24 hour period is not limited to a calendar day.

The application of daily rates for Program Audio service for consecutive 24 hour periods during a consecutive 30 day period is as follows. Daily rates will be topped at an amount equal to the monthly rate (i.e., the charge to the customer for usage billed at daily rates will not exceed the monthly rate). For each day or partial day that the service is available for use after the daily rates have been topped, a charge equal to 1/30th of the monthly rate will apply.

PUBLIC SERVICE COMMISSION  
OF KENTUCKY  
EFFECTIVE

MAR 3 1992

PURSUANT TO 807 KAR 5:011,  
SECTION 9(1)

Issued: February 7, 1992

Effective: March 3, 1992  
PUBLIC SERVICE COMMISSION MANAGER

*Robert E. Aigmon* for

President, Cincinnati, Ohio

**Vice President - Regulatory Affairs**

ACCESS SERVICE TARIFF  
PSC No. 2

CINCINNATI BELL TELEPHONE COMPANY

1st Revised Page 327  
Cancels Original Page 327

7. Special Access Service (Cont'd)

7.4 Rate Regulations (Cont'd)

7.4.1 Types of Rates and Charges (Cont'd)

(C) Nonrecurring Charges

Nonrecurring charges are one-time charges that apply for specific work activity (i.e., installation or change to an existing service). The types of nonrecurring charges that apply for Special Access Service are: installation of service, installation of optional features and functions, and service rearrangements.

(1) Installation of Service

Nonrecurring charges apply to each service installed. The nonrecurring charges for the installation of service are set forth in 7.5 following as a nonrecurring charge for the Channel Termination rate element.

(2) Installation of Optional Features and Functions

Nonrecurring charges apply for the installation of some of the optional features and functions available with Special Access Service. The charge applies whether the feature or function is installed coincident with the initial installation of service or at any time subsequent to the installation of the service.

The optional features for which nonrecurring charges apply are:

- Voice Grade Data Capability
- Voice Grade Telephoto Capability
- Program Audio Gain Conditioning
- Program Audio Stereo
- High Capacity Clear Channel Capability
- Service to Service through Connect Arrangement - 1.544Mbps (N)

PUBLIC SERVICE COMMISSION  
OF KENTUCKY  
EFFECTIVE

OCT 26 1992

PURSUANT TO 807 KAH 5:011.

Issued: September 24, 1992

Effective October 26, 1992

*Robert E. Aigmon*

for

President, Cincinnati, Ohio

BY:

*Sharon Walker*  
PUBLIC SERVICE COMMISSION MANAGER

Vice President - Regulatory Affairs

ACCESS SERVICE TARIFF  
PSC No. 2

CINCINNATI BELL TELEPHONE COMPANY

Original Page 328

7. Special Access Service (Cont'd)

7.4 Rate Regulations (Cont'd)

7.4.1 Types of Rates and Charges (Cont'd)

(C) Nonrecurring Charges (Cont'd)

(3) Service Rearrangements

Service rearrangements are changes to existing (installed) services which do not result in either a change in the minimum period requirements as set forth in 5.2.5 (E) preceding or a change in the physical location of the point of the termination at a customer designated premises. Changes which result in the establishment of new minimum period obligations are treated as disconnects and starts.

Changes in the physical location of the point of the termination are treated as moves and are described and charged for as set forth in 7.4.5 following.

The charge to the customer for the service rearrangement is dependent on whether the change is administrative only in nature or involves actual physical change to the service.

Administrative changes will be made without charge(s) to the customer. Such changes require the continued provision and billing of the Access Service to the same entity (i.e., customer remains responsible for all outstanding indebtedness for the Access Service). Administrative changes are as follows:

- Change of customer name, (i.e., the customer of record does not change but rather the customer of record changes its name--e.g., AT&T-Long Lines to AT&T-Communications),
- Change of customer or customer's end user premises address when the change of address is not a result of a physical relocation of equipment,
- Change in billing data (name, address, ~~or contact~~ name or telephone number),
- Change of customer circuit identification,
- Change of billing account number,
- Change of customer test line number,
- Change of customer or customer's end user name or telephone number, and
- Change of jurisdiction

PUBLIC SERVICE COMMISSION  
OF KENTUCKY  
EFFECTIVE

MAR 3 1992

PURSUANT TO 807 KAR 5:011,  
SECTION 9 (1)

Issued: February 7, 1992

Effective: *March 3, 1992*  
PUBLIC SERVICE COMMISSION MANAGER

*Robert E. Aigmon* for President, Cincinnati, Ohio

Vice President - Regulatory Affairs



7. Special Access Service (Cont'd)

7.4 Rate Regulations (Cont'd)

7.4.1 Types of Rates and Charges (Cont'd)

(C) Nonrecurring Charges (Cont'd)

(3) Service Rearrangements (Cont'd)

All other service rearrangements will be charged for as follows:

- If the change involves the addition of other customer designated premises to an existing multipoint service, the nonrecurring charge for the channel termination rate element will apply. The charge(s) will apply only for the location(s) that is being added.
- If the change involves the addition of an optional feature or function which has a separate nonrecurring charge, that nonrecurring charge will apply.
- If the change involves changing the type of Signaling Capability on a Voice Grade service, a charge equal to the Voice Grade channel termination rate element nonrecurring charge will apply. The charge will apply per service termination affected.
- For all other changes, including the addition of an optional feature or function without a separate nonrecurring charge, a charge equal to a channel termination rate element nonrecurring charge will apply. Only one such charge will apply per channel termination, for all changes of this type made at one time.

7.4.2 Surcharge for Special Access Service

(A) General

In addition to the rates and charges described in PUBLIC SERVICE COMMISSION preceding, there is a monthly surcharge that applies to KENTUCKY Special Access Service. The Special Access Surcharge EFFECTIVE compensates the Telephone Company for use of the local exchange network when Special Access Service is connected to a PBX or equivalent device which is capable of interconnecting the Special Access Service with local exchange service. MAR 3 1992

Issued: February 7, 1992

Effective: MARCH 9 1992 PURSUANT TO 807 KAR 5:011.

*Robert E. Aigmon*

for

President, Cincinnati, Ohio

BY: *Sharon Belle*  
PUBLIC SERVICE COMMISSION MANAGER

ACCESS SERVICE TARIFF  
PSC No. 2

CINCINNATI BELL TELEPHONE COMPANY

Original Page 330

7. Special Access Service (Cont'd)

7.4 Rate Regulations (Cont'd)

7.4.2 Surcharge for Special Access Service (Cont'd)

(A) General (Cont'd)

The Telephone Company will automatically bill the surcharge on each Special Access Service installed irrespective of whether the inter-connection capability exists in the customer's premises equipment or in a Centrex-CO type switch unless written certification is received from the customer certifying exemption status as set forth in (B) following.

(B) Special Access Surcharge Exemptions

The Special Access Service will be exempted from the surcharge if the customer provides the Telephone Company written certification that the intrastate Special Access Service termination is one of the following:

- (1) an open-end termination in a Telephone Company switch of an FX line, including CCSA and CCSA-equivalent ONALS; or
- (2) an analog channel termination that is used for radio program transmission; or
- (3) a termination used for TELEX service; or
- (4) a termination that by the nature of its operating characteristics could not make use of Telephone Company common lines; or

PUBLIC SERVICE COMMISSION  
OF KENTUCKY  
EFFECTIVE

MAR 3 1992

PURSUANT TO 807 KAR 5:011,  
SECTION 9 (1)

BY:   
EFFECTIVE: March 3, 1992  
PUBLIC SERVICE COMMISSION MANAGER

Issued: February 7, 1992

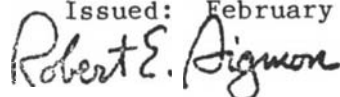

for

President, Cincinnati, Ohio

ACCESS SERVICE TARIFF  
PSC No. 2

CINCINNATI BELL TELEPHONE COMPANY

Original Page 331

7. Special Access Service (Cont'd)

7.4 Rate Reulations (Cont'd)

7.4.2 Surcharge for Special Access Service (Cont'd)

(B) Special Access Surcharge Exemptions (Cont'd)

- (5) a termination that interconnects either directly or indirectly to the local exchange network where the usage is subject to Carrier Common Line charges\* such as, where the Special Access Service accesses only FGA and no local exchange lines, or Special Access Service between customer points of termination or Special Access Service connecting CCSA or CCSA-type equipment (inter-machine trunks); or
- (6) a termination that the customer certifies to the Telephone Company is not connected to a PBX or other device capable of interconnecting the special access facility to a local exchange subscriber line. If a user's equipment is prevented from interconnecting private lines with the local exchange lines due to actual operating practicalities or limitations -- resulting from either hardware or software restrictions -- then it is not capable of leakage. Thus no surcharge should be assessed.

PUBLIC SERVICE COMMISSION  
OF KENTUCKY  
EFFECTIVE

MAR 3 1992

PURSUANT TO 807 KAR 5:011,  
SECTION 9 (1)  
BY: Cheryl Deller  
PUBLIC SERVICE COMMISSION MANAGER

\* Resellers of WATS Access Line Service who are exempted from paying CCL charges during the transition period of June 1, 1986 to January 1, 1987 should not be assessed any Special Access Surcharge on the closed end.

Issued: February 7, 1992

Effective: March 3, 1992

Robert E. Aigmon for President, Cincinnati, Ohio

Vice President - Regulatory Affairs

7. Special Access Service (Cont'd)

7.4 Rate Regulations (Cont'd)

7.4.2 Surcharge for Special Access Service (Cont'd)

(C) Exemption Certification

- (1) Special Access Services which are terminated as set forth in (B) preceding will be exempted from the Special Access Surcharge if the customer provides the Telephone Company with a written notification certifying exemption. Such notification shall be provided by the customer (1) at the time the Special Access Service is ordered or installed; (2) at such time as the Special Access Service is reterminated to a device not capable of interconnecting to the local exchange network, or (3) at such time as the Special Access Service becomes associated with a Switched Access Service that is subject to Carrier Common Line charges.
- (2) If written certification is not received at the time the Special Access Service is obtained, the surcharge will be applied. Exempt status will become effective on the certification date indicated by the customer, subject to the regulations in (D) following.
- (3) The exemption certification is to be provided by the customer ordering the service. The certification must be signed by the customer or authorized representative and include the category of exemption, as set forth in (B) preceding, for each termination, and the date which the exemption is effective.
- (4) The customer shall also notify the Telephone Company when an exempted Special Access Service is changed or reterminated such that the exemption is no longer applicable.

(D) Crediting the Surcharge

The Telephone Company will cease billing the Special Access Surcharge when certification that the Special Access Service has become exempt from the surcharge, as set forth in (B) preceding is received. If the status of the Special Access Service was changed prior to receipt of the exemption certification, the Telephone Company will credit the customer's account, not to exceed ninety (90) days, based on the effective date of the change specified by the customer in the letter of certification.

PUBLIC SERVICE COMMISSION  
OF KENTUCKY  
EFFECTIVE

MAR 3 1992

PURSUANT TO 807 KAR 5:011,  
SECTION 9.11

Issued: February 7, 1992

Effective: March 3, 1992

*Robert E. Aignone*

for

President, Cincinnati, Ohio

BY: *Shirley Holte*  
PUBLIC SERVICE COMMISSION MANAGER

ACCESS SERVICE TARIFF  
PSCK No. 2

CINCINNATI BELL TELEPHONE COMPANY

Original Page 333

7. Special Access Service (Cont'd)

7.4 Rate Regulations (Cont'd)

7.4.2 Surcharge for Special Access Service (Cont'd)

(D) Crediting the Surcharge (Cont'd)

On June 1, 1986, the Telephone Company will begin to bill the Special Access Surcharge for WATS Access Lines presently in service. Payment of any Special Access Surcharge billed on WATS Access Lines in service as of June 1, 1986, may be deferred, without penalty, for up to ninety (90) days from the date of the first bill ordered for the Special Access Surcharge.

If appropriate exemption certification is not received by the Telephone Company by the end of the ninety (90) days deferral period, the billed Special Access Surcharges will become due. These charges, if unpaid, will be subject to a late payment charge as set forth in Section 2.4.1 (B)(2) preceding. Customers who provide exemption certification within the first ninety (90) days following the surcharge effective date, will be given credit for the surcharge to the surcharge effective date.

PUBLIC SERVICE COMMISSION  
OF KENTUCKY  
EFFECTIVE

MAR 3 1992

PURSUANT TO 807 KAR 5:011,  
SECTION 9 (1)

BY: *Chas. J. Miller*

Effective March 3, 1992  
PUBLIC SERVICE COMMISSION MANAGER

Issued: February 7, 1992

*Robert E. Sigmon*

for

President, Cincinnati, Ohio

Vice president - Regulatory Affairs

ACCESS SERVICE TARIFF  
PSC No. 2

CINCINNATI BELL TELEPHONE COMPANY

1st Revised Page 334  
Cancels Original Page 334

7. Special Access Service (Cont'd)

7.4 Rate Regulations (Cont'd)

7.4.2 Surcharge for Special Access Service (Cont'd)

(E) Application of Rates

- (1) The monthly Special Access Surcharge applies to Special Access Services arranged, as set forth in (A) preceding, on a per voice equivalent basis as shown in the following example. The rate for the Special Access Surcharge is set forth in 7.5.11 following

| Special Access Service | Voice Grade Equivalent |   | Surcharge | Monthly Charge |
|------------------------|------------------------|---|-----------|----------------|
| Voice Grade            | 1                      | x | \$25      | \$ 25.00       |
| DS1                    | 24                     | x | \$25      | \$600.00       |

- (2) In the case of multipoint Special Access Service, one Special Access Surcharge will apply for each termination at a customer designated premises except that no surcharge applies at the customer designated premises when such premises are an interexchange carrier's point of termination.
- (3) The Telephone Company will bill the surcharge to the customer who orders the Special Access Service unless the Service is exempt as set forth in (B) preceding.

7.4.3 Rates Zones

Rate zones are applicable to CBT MercNET 1.5 (DS1) and CBT MercNET 45 (DS3) services described in this section. Each Telephone Company Wire Center has been assigned to a rate zone as described in 18, following. Channel Termination, Channel Mileage Fixed and Per Mile, Alternate Central Office and Interoffice Access Diversity rates are dependent upon the zone assignment of the Service Wire Center. Channel Mileage that is computed between wire centers in different rate zones will be assessed the rates in the higher rate zone. Multiplexing rates will be determined by the location of the multiplexing arrangement.

Issued: February 23, 1999

Effective: January 25, 1999

President, Cincinnati, Ohio

N)  
N)

7. Special Access Service (Cont'd)

7.4 Rate Regulations (Cont'd)

7.4.4 Minimum Periods

The minimum service period for all services is one month except as follows:

- (A) The minimum service period for part-time and occasional Program Audio services is one day (i.e., a continuous 24 hour period, not limited to a calendar day).
- (B) The minimum period for individual case basis (ICB) services is one month unless otherwise specified in the ICB offering
- (C) For Optional Payment Plans (OPP) for Digital Data Service, MercNet 45 and 1.544 High Capacity Services the minimum period is specified in paragraph 7.4.9 following.
- (D) The minimum service period for Point-to-Point, OC-3, OC-12 or OC-48 Services is 12 months. After the minimum period is satisfied, see specified regulations in paragraph 7.4.9 following. (N)
- (E) The minimum service period for OC-3 Dedicated Ring, OC-12 Dedicated Ring or OC-48 Dedicated Ring service is 36 months. After the minimum period is satisfied, see specified regulations in paragraph 7.4.9 following. (N)

7.4.5 Moves

A move involves a change in the physical location of one of the following.

- . The Point of Termination at the customer's premises
- . The customer's premises

The charges for the move are dependent on whether the move is to a new location within the same building or to a different building.

All Moves will be treated as a discontinuance and start of service and all associated nonrecurring charges will apply. New minimum period requirements will be established for the new services. The customer will also remain responsible for satisfying all outstanding minimum period charges for the discontinued services.

ACCESS SERVICE TARIFF  
PSCK No. 2

CINCINNATI BELL TELEPHONE COMPANY

2nd Revised Page 336  
Cancels 1st Revised Page 336

7. Special Access Service (Cont'd)

7.4 Rate Regulations (Cont'd)

7.4.6 Mileage Measurement

The mileage to be used to determine the monthly rate for the Channel Mileage is calculated on the airline distance between the locations involved, i.e., the serving wire centers associated with two customer designated premises, a serving wire center associated with a customer designated premises and a Telephone Company hub, or two Telephone Company hubs. The serving wire center associated with a customer designated premises is the serving wire center from which this customer designated premises would normally obtain dial tone.

Mileage is shown in 7.5 following in terms of mileage bands. To determine the rate to be billed, first compute the mileage using the V&H coordinates method, as set forth in the NATIONAL EXCHANGE CARRIER ASSOCIATION, INC. TARIFF FCC No. 4, then find the band into which the computed mileage falls and apply the rate shown for that band. When the calculation results in a fraction of a mile, always round up to the next whole mile before determining the mileage band and applying the rates.

When hubs are involved, mileage is computed and rates applied separately for each section of the Channel Mileage, i.e., customer designated premises serving wire center to hub, hub to hub and/or hub to customer designated premises serving wire center. However, when any service is routed through a hub for purposes other than customer specified bridging, multiplexing or Customer Network Reconfiguration Service (e.g., the Telephone Company chooses to so route for test access purposes), rates will be applied only to the distance calculated between the serving wire centers associated with the customer designated premises.

PUBLIC SERVICE COMMISSION  
OF KENTUCKY  
EFFECTIVE

MAY 23 1995

PURSUANT TO 807 KAR 5:011.  
SECTION 9(1)

BY: Jordan C. Neal  
FOR THE PUBLIC SERVICE COMMISSION

(D)  
|  
(D)

Issued: June 13, 1995

Effective: May 23, 1995

*Deborah A. Nisch* President, Cincinnati, Ohio  
Vice President  
Integrated Corporate Planning for



ACCESS SERVICE TARIFF  
PSC No. 2

CINCINNATI BELL TELEPHONE COMPANY

Original Page 337

7. Special Access Service (Cont'd)

7.4 Rate Regulations (Cont'd)

7.4.7 Facility Hubs

A customer has the option of ordering Voice Grade facilities or digital high capacity facilities (i.e., DS1, DS1C, DS2, DS3 or DS4) to a facility hub for channelizing to individual services requiring lower capacity facilities (e.g., Telegraph, Voice, Program Audio, etc.).

Different locations may be designated as hubs for different facility capacities, e.g., multiplexing from digital to digital may occur at one location while multiplexing from digital to analog may occur at a different location. When placing an Access Order the customer will specify the desired hub. The National Exchange Carrier Association, Inc. Tariff FCC No. 4 identifies serving wire centers, hub locations and the type of multiplexing functions available.

Some of the types of multiplexing available include the following:

- from higher to lower bit rate
- from higher to lower bandwidth
- from digital to voice frequency channels

End to end services may be provided on channels of these facilities to a hub. The transmission performance for the end to end service provided between customer designated premises will be that of the lower capacity or bit rate. For example, when a 1.544 Mbps facility is multiplexed to voice frequency channels, the transmission performance of the channelized services will be Voice Grade, not High Capacity.

PUBLIC SERVICE COMMISSION  
OF KENTUCKY  
EFFECTIVE

MAR 3 1992

PURSUANT TO 807 KAR 5:011,  
SECTION 9 (1)

BY: Sharon Keller  
PUBLIC SERVICE COMMISSION MANAGER

Effective: March 3, 1992

Issued: February 7, 1992

Robert E. Aigunon for President, Cincinnati, Ohio

Vice President - Regulatory Affairs

ACCESS SERVICE TARIFF  
PSC No. 2

CINCINNATI BELL TELEPHONE COMPANY

Original Page 338

7. Special Access Service (Cont'd)

7.4 Rate Regulations (Cont'd)

7.4.7 Facility Hubs (Cont'd)

The Telephone Company will commence billing the monthly rate for the facility to the hub on the date specified by the customer on the Access Order. Individual services utilizing these facilities may be installed coincident with the installation of the facility to the hub or may be ordered and/or installed at a later date, at the option of the customer. The customer will be billed for a Voice Grade or a High Capacity digital Channel Termination, Channel Mileage (when applicable) and the multiplexer at the time the facility is installed. Individual service rates (by service type) will apply for a Channel Termination and additional Channel Mileage (as required) for each channelized service. These will be billed to the customer as each individual service is installed.

Cascading multiplexing occurs when a high capacity digital channel is de-multiplexed to provide channels with a lesser capacity and one of the lesser capacity channels is further de-multiplexed. For example, a MercNET 45 (DS3) facility is de-multiplexed to 28 DS1 facilities and then one of the DS1 facilities is further de-multiplexed to individual Digital Data Service channels (i.e., 2.4, 4.8, 9.6, 56 or 64 kbps channels).

When cascading multiplexing is performed, whether in the same or a different hub, a charge for the additional multiplexing unit also applies. When cascading multiplexing is performed at different hubbing locations, Channel Mileage charges also apply between the hubs.

**PUBLIC SERVICE COMMISSION  
OF KENTUCKY  
EFFECTIVE**

MAR 3 1992

**PURSUANT TO 807 KAR 5:011,  
SECTION 9<sup>(1)</sup>**

BY:   
PUBLIC SERVICE COMMISSION MANAGER

Issued: February 7, 1992

Effective: March 3, 1992

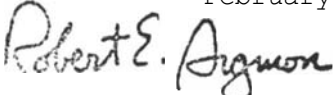
 **for** President, Cincinnati, Ohio

ACCESS SERVICE TARIFF  
PSCK No. 2

CINCINNATI BELL TELEPHONE COMPANY

Original Page 339

7. Special Access Service (Cont'd)

7.4 Rate Regulations (Cont'd)

7.4.7 Facility Hubs (Cont'd)

Although not requiring multiplexing, certain Program Audio services must be routed to Telephone Company designated hubs when connection is desired with other broadcast facilities. A customer can order full-time and/or part-time service(s) between customer designated premises and a hub and will be billed accordingly at the rates set forth in 7.5.4 or 7.5.5 following for the full-time or part-time service, as appropriate. At the request of a customer, the full-time and/or part-time services provided to the hub may be connected together in the following configurations: full-time to full-time, full-time to part-time or part-time to part-time. The customer will be charged for each such connection made at the rates for Other Labor as set forth in 13.2.6(C) following. The rates that apply for the service between each customer designated premises and the hub are a Channel Termination and Channel Mileage, if applicable. In addition, for Program Audio Services, rates for optional features and functions may be applicable. For two-point Program Audio services not requiring hubbing, circuit configuration will be as shown in 7.1.3 for two-point service.

PUBLIC SERVICE COMMISSION  
OF KENTUCKY  
EFFECTIVE

MAR 3 1992

PURSUANT TO 807 KAR 5:011,  
SECTION 9 (1)

BY: Gary Belle  
PUBLIC SERVICE COMMISSION MANAGER

Issued: February 7, 1992

Effective: March 3, 1992

Robert E. Aiguon for President, Cincinnati, Ohio

Vice President - Regulatory Affairs

ACCESS SERVICE TARIFF  
PSCK No. 2

CINCINNATI BELL TELEPHONE COMPANY

2nd Revised Page 340  
Cancels 1st Revised Page 340

7. Special Access Service (Cont'd)

7.4 Rate Regulations (Cont'd)

7.4.8 Shared Use High Capacity Services and OC-3, OC-12, and OC-48 Services (T)

Shared use occurs when Special Access Service and Switched Access Service including CCSAC signaling connections are provided over the same High Capacity facilities through a common interface. The facility will be ordered, provided and rated as Special Access Service (i.e., Channel Termination, Channel Mileage, as appropriate, and Multiplexer). The nonrecurring charge that applies when the shared use facility is installed will be the nonrecurring charge associated with the appropriate Special Access High Capacity Channel Termination. Individual service including Switched Access CCSAC signaling connections (i.e. Switched or Special Access) non-recurring charges will not apply to the individual channels of the shared used facility. Rating as Special Access will continue until such time as the customer chooses to use a portion of the available capacity for providing Switched Access Service including CCSAC signaling connections. As each individual channel is activated for Switched Access Service including CCSAC signaling connections, the Special Access Channel Termination, Channel Mileage and Multiplexer rates, as appropriate, will be reduced accordingly (e.g., 1/24th for a DSI service, etc.). The customer must place an order for each individual Switched or Special Access Service including CCSAC signaling connections utilizing the Shared Use Facilities and specify the channel assignment for each such service including CCSAC signaling connections.

---

Issued: February 23, 1999

Effective: January 25, 1999

President, Cincinnati, Ohio

ACCESS SERVICE TARIFF  
PSCK No. 2

CINCINNATI BELL TELEPHONE COMPANY

4th Revised Page 341  
Cancels 3rd Revised Page 341

7. Special Access Service (Cont'd)

7.4 Rate Regulations (Cont'd)

7.4.8 Shared Use High Capacity Services and OC-3, OC-12, and OC-48 Services  
(Cont'd)

Switched Access Service rates and charges as set forth in 6.8 preceding will apply for each channel of the shared use facility that is used to provide a Switched Access Service including CCSAC signaling connections. The ordering, provisioning and rating of Switched Access Shared Use facilities is set forth in 6.7.14 preceding. Where Special Access Service is provided utilizing a channel of the shared use facility to a Hub, High Capacity and OC Service rates and charges will apply for the facility to the Hub as set forth preceding and individual service rates and charges will apply from the Hub to the customer designated premises. The rates and charges that will apply to the portion from the Hub to the customer designated premises will be dependent on the specific type of Special Access Service that is provided (e.g., Voice Grade, Telegraph, etc.) The applicable rates and charges will include a Channel Termination and Channel Mileage, if applicable. Rates and charges for optional features and functions associated with the service, if any, will apply as set forth in 7.5 following.

7.4.9 Payment Plans for Frame Relay Service, Digital Data Service, MercNET 45, 1.544 High Capacity Services and OC-3, OC-12, OC-48 Services, and Shared SONET Service

The Optional Payment Plan (OPP) is a provision that allows a customer to pay a fixed rate for specific Frame Relay Service, Digital Data Service, MercNET 45, 1.544 High Capacity Service, OC-3, OC-12, OC-48 Services, and Shared SONET Service over a 36 or 60 month payment period. During the effective term, monthly rates for services installed under this arrangement will not be subject to Telephone Company initiated rate changes.

Frame Relay Service, Digital Data Service, MercNET 45, and 1.544 High Capacity, (C)  
OC-3, OC-12, and OC-48 Service rates, and Shared SONET Service and charges for (C)  
which the OPP is available are listed in 7.5.8, 7.5.9, 7.5.12, 7.5.13, 7.5.14  
and 17.6 following.

ACCESS SERVICE TARIFF  
PSC No. 2

CINCINNATI BELL TELEPHONE COMPANY

4th Revised Page 342  
Cancels 3rd Revised Page 342

7. Special Access Service (Cont'd)

7.4 Rate Regulations (Cont'd)

7.4.9 Payment Plans for Frame Relay Service, Digital Data Service, MercNET 45, 1.544 High Capacity Service and OC-3, OC-12, and OC-48 Services, and Shared SONET Service. (Cont'd)

Customers subscribing to the OPP will be subject to nonrecurring charges as specified in 7.4.1(C), 7.5.8(A) and 7.5.9(A) for installation and rearrangements of services covered by the plan. The nonrecurring charges will not be spread over the OPP term.

During a customer's OPP/DCP term, the customer shall pay current rates provided they do not exceed the original rate contracted for by the customer. Conversion of service may be made to a new OPP/DCP term of the same or different length or to a higher speed service or to the same or higher speed Shared SONET service. If the expiration date for the new service or OPP/DCP term is beyond the end of the original OPP/DCP term, the remaining OPP/DCP charges for the original term will not apply.

At the expiration of the OPP term and if the customer wishes to continue Frame Relay Service, Digital Data Service, MercNET 45, 1.544 High Capacity Service, and OC-3, OC-12, OC-48 Services, and Shared SONET Service, the customer may elect:

- Prevailing month-to-month tariff rates
- A new OPP at the prevailing OPP rate, if available

The customer continues to receive the OPP rate on a month-to-month basis for a period of up to six months following the completion of the term. After the six months, the rates will automatically revert to the month-to-month rates.

During an OPP term, a customer may move one Channel Termination service to another location while keeping the OPP in force, provided the customer and customer's end user remain the same and no lapse in service occurs.

The Minimum Period for service provided under an OPP is the same as the OPP term selected by the customer (i.e. 36 or 60 month payment period). The Minimum Period for service provided under the month-to-month payment arrangement is 12 months for Frame Relay Service, MercNET 45 Service, OC-3, OC-12, and OC-48 Services, and Shared SONET Service, and 1 month for 1.544 High Capacity Service and Digital Data Service. (C)

7. Special Access Service (Cont'd)

7.4 Rate Regulations (Cont'd)

7.4.9 Payment Plans for Frame Relay Service. Digital Data Service. MercNET 45, 1.544 High Capacity Service and OC-3. OC-12, OC-48 Services. and Shared SONET Service (Cont'd)

(T)  
|  
(T) (C)

Customers requesting termination of service prior to the expiration date of the Minimum Period will be liable for payment of a Minimum Period Charge. The Minimum Period Charge for all OPP terms will be calculated as follows:

The service that is in place less than 12 months the customer would pay the monthly rate for the service.

The dollar difference between (a) the current OPP rate for the OPP term that could have been completed during the time the service was actually in service, and (b) the customer's current OPP rate for each month the service was provided.

For example, a customer subscribed to a 60 month OPP term and disconnected service during the 39th month. This customer's minimum period charge would be:

$[36 \text{ month OPP rate} - 60 \text{ month OPP rate}] \times 39 = \text{Minimum Period Charge.}$

The 36 month OPP term could have been completed during the months the service was actually in service.

All minimum period charges will be based on the OPP rates in effect at the time of termination.

Minimum Period Charges for all OPP terms that have been initiated prior to March 25, 1993, may, at the customer's request, be charged as described above or pay a percentage of the monthly charges for the remainder of the term as indicated below:

ACCESS SERVICE TARIFF  
PSCK No. 2

CINCINNATI BELL TELEPHONE COMPANY

1st Revised Page 343.1  
Cancels Original Page 343.1

7. Special Access Service (Cont'd)

7.4 Rate Regulations (Cont'd)

7.4.9 Payment Plans for Frame Relay Service, Digital Data Service, (C) MercNET 45, 1.544 High Capacity Service and OC-3, OC-12, OC-48 Services, and Shared SONEt Service (Cont'd) (T)  
|  
(T)

MPC = MR x N x P

MPC = Minimum Period Charge for one Channel Termination

MR = Channel Termination Monthly Rate

N = Number of months remaining in the Minimum Period (partial months fractionalized using a 30 day month).

P = Appropriate fixed percentage for the associated Minimum Period from the following table:

| Minimum |            |
|---------|------------|
| Period  | Percentage |
| 12      | 100        |
| 36      | 75         |
| 60      | 60         |

7.4.10 MercNET 45 High Capacity Service - 12 Pack Arrangement

In addition to rate regulations preceding in 7.4.9, the following terms and conditions are listed below:

New contract periods would be established at the time the circuits are converted to the new 12 pack arrangement.

The minimum for the 12 pack arrangement is 12 MercNET 45's. If the customer goes below the minimum the customer will automatically be reverted to the existing tariff structure by contract period. The appropriate rate in the existing tariff structure will be applied based on the existing contract period of the 12 pack arrangement.



ACCESS SERVICE TARIFF  
PSCK No. 2

CINCINNATI BELL TELEPHONE COMPANY

1st Revised Page 344  
Cancels **Original** Page 344

7. Special Access Service (Cont'd)

7.4 Rate Regulations (Cont'd)

7.4.11 Customer Network Reconfiguration Service (CNRS)

(C)

(A) Service Establishment Charge

The Service Establishment Charge applies per customer database setup. The charge includes the initial setup of the database which contains all of the pertinent information for circuits and facilities that the customer wishes to control or monitor. Partitioning of customer circuits and initial customer training are also included.

(B) CNRS Port Charges

One DS1 Port is required for each DS1 facility which connects a customer designated premises to a CNRS hub. Two DS1 Ports are required for each DS1 mid link (i.e., the DS1 facility which connects a CNRS hub to another CNRS hub in the provision of CNRS service for a given customer). One DSO Port is required for each Voice Grade facility and 9.6, 56 or 64 kbps Digital Data facility which connects a customer designed premises to a CNRS hub. The monthly rate and nonrecurring charges are applicable as specified in 7.4.1 preceding.

(C)  
(C)

(C) Charges for Reconfigurations and Database Changes Performed by the Telephone Company

Reconfigurations and database changes performed by the Telephone Company, at the request of the customer, are subject to the charges specified in 7.5.10. The charge applies per one half hour (or fraction thereof) of effort expended by the Telephone Company in making the requested reconfiguration or change.

When a customer adds a Voice Grade Service, Digital Data Services and/or a DS1 High Capacity Service to an existing CNRS configuration the charge applies for inputting the new circuit and facility information.

(C)  
PUBLIC SERVICE COMMISSION  
KENTUCKY  
EFFECTIVE

MAY 23 1995

PURSUANT TO 807 KAR 5.011,  
SECTION 9(1)

BY Jordan C. Neal  
FOR THE PUBLIC SERVICE COMMISSION

Issued: June 13, 1995

Effective: May 23, 1995

Deborah A. Nisch Resident, Cincinnati, Ohio

Vice Resident  
Integrated Corporate Planning for

7.4 Rate Regulations (Cont'd)  
7.4.12 Discount Commitment Program (DCP)

(A) General Description

The Discount Commitment Program (DCP) provides the customer with rate stabilization and discounted rates for Digital Data Service, 1.544 High Capacity Service and MercNET 45 Service and Shared SONET Service (described) in Sections 7.2.8 and 7.2.9. and 7.2.13. The customer agrees to a minimum service commitment per service when establishing a DCP. Customers may disconnect or move Channel Terminations and not be subject to (C)

Maximum Termination Liability charges as long as commitment levels are maintained.

DCPs may be established by service and be of either 36 or 60 months duration. A customer may have only one DCP per service in effect at one time. For example, a customer that has a 36-month DCP for Digital Data Service may not establish a second Digital Data Service until the current DCP expires.

Monthly rates for services installed under a DCP will change as Telephone Company-initiated rate changes become effective but during the DCP term will not exceed the original monthly rate in effect at the beginning of customer's DCP term. During the term of the selected DCP, Telephone Company initiated rate changes (increases or decreases) will automatically be applied to the monthly rates for the remaining months of the current DCP term. But in no case will any rate change cause the monthly rate during the DCP term to exceed that in effect at the beginning of the customer's DCP term.

(B) Commitment Level

A customer establishes a DCP term by committing 90 percent of their in service Channel Termination Network Access Connection, or off-Network Connections to a term of either 36 or 60 months duration. Although the commitment is based upon Channel Termination (CTs) Network Access Connections (NAC's) and Off-Network Connection (ONACS), the following rate elements will all receive DCP rates: (C)

- Channel Termination
- Channel Mileage
- Network Access Connection (C)
- Off-Network Access Connection
- Service Area Transport (C)

ACCESS SERVICE TARIFF

PSCK No. 2

CINCINNATI BELL TELEPHONE COMPANY

1st Revised Page 344.2  
Cancels Original Page 344.2

7. Special Access Service (Cont'd)

7.4 Rate Regulations (Cont'd)

7.4.12 Discount Commitment Program (DCP)

(B) Commitment Level (Cont'd)

The customer will not receive the DCP rates for in-service levels above the 90 percent commitment level established. For example, a customer with 100 CTs in-service and commits to 90 CTs (i.e. 90 percent) will receive the DCP rates for up to 90 CTs.

If a customer's actual in-service level falls below the commitment level, the customer will be billed for the commitment level of CTs at DCP Rates. For example, a customer that commits 90 CTs but has only 70 CTs in service will be billed the DCP rates for 90 CTs.

(C) 90-Day Review Period

No adjustments, for being above or below commitment level (as described in (B) above). in monthly billing for a DCP will be made until 90 days after Telephone Company notification to the customer that the commitment level has been exceeded or not been met. This will insure that customers will not be penalized for aberrations in Channel Termination Network Access Connection or Off-Network Access Connection (T) counts caused by timing differentials in disconnection and installation.

Customer's bills will not be adjusted for being outside the parameters described in 7.4.12(B), preceding during the 90 day review period. Additionally, customers will continue to be billed the adjustments (following the 90 day review period) for being outside the described parameters until the commitment level is met or increased. A new 90-day review period will be initiated if the customer's actual in-service level subsequently falls outside the described parameters.

7. Special Access Service (Cont'd)

7.4 Rate Regulations (Cont'd)

7.4.12 Discount Commitment Program (DCP)

(D) Increasing the DCP Commitment Level

Customers may increase their commitment level at any time by notifying the Telephone Company in writing. An increase in the commitment level will not change the expiration date of the DCP

When a commitment level is increased, the actual in-service CT level at the time of the increase will be used to calculate billing adjustments as described in Section 7.4.12(B), preceding.

(E) Decreasing the DCP Commitment Level and Termination Liabilities

Customers may decrease their commitment level only by paying termination liability charges on the number of Channel Terminations, Network Access Connections or Off- (C) Network Access Connections by which the commitment level is decreased. Termination Liabilities will apply to (C) Digital Data, 1.544 High Capacity, MercNET 45 and Shared SONET Service. For (C) example, a customer has a commitment level of 90 CTs. The customer then decreases this commitment level to 70 CTs. The customer must pay termination liabilities on 20 CTs.

The Termination Liability for DCP is calculated to be the dollar difference between the current DCP rate for the DCP term that could have been completed during the time the service was actually in service, or the monthly rate for services in service, or the monthly rate for services in place less than 36 months, and the customer's current DCP rate for each month the service was provided.

For example, a customer subscribing to a 60-month DCP term reduced their CT commitment by 20 CTs during the 37th month. This customer's termination charge would be:

$20 \text{ CTs} \times (36 \text{ month DCP rate} - 60 \text{ month DCP rate}) \times 37 \text{ months} = \text{Termination Charge}$

A decrease in the commitment level will not change the expiration date of the DCP.

ACCESS SERVICE TARIFF  
PSC No. 2

CINCINNATI BELL TELEPHONE COMPANY

1st Revised Page 344.4  
Cancels Original Page 344.4

7. Special Access Service (Cont'd)

7.4 Rate Regulations (Cont'd)

7.4.12 Discount Commitment Program (DCP)

(F) Upgrading a DCP Service

When a customer upgrades a Digital Data service being billed DCP rates to a 1.544 High Capacity, the Digital Data service DCP commitment level will be reduced at the customer's request (up to a maximum of 24) and no termination liabilities will apply. If the customer has a DCP for a 1.544 High Capacity, the 1.544 High Capacity DCP commitment level will be increased if the customer requests that it be increased. When a customer upgrades a 1.544 High Capacity service being billed DCP rates to a MercNET 45 service with the same termination points, the customer's 1.544 High Capacity DCP commitment level will be reduced at the customer's request (up to a maximum of 28) and no termination liabilities will apply.

(G) Conversion to an Optional Payment Plan (OPP)

Customers may convert services from a DCP term to an OPP as described in 7.4.9. preceding. No termination liabilities will apply to services converted to an OPP term of the same or longer length than the DCP term. Additionally, the customer's DCP commitment level will be reduced by the number of CTs, NALCS, or ONACS, associated with the service, converted to an OPP term. (T)

ACCESS SERVICE TARIFF  
 PSCK No. 2

CINCINNATI BELL TELEPHONE COMPANY  
 7. Special Access Service (Cont'd)

3rd Revised Page 345  
 Cancels 2nd Revised Page 345

7.5 Rates and Charges

7.5.1 Metallic Service

|                                  | Monthly<br>USOC | <u>Rates</u> | Nonrecurring<br><u>Charges</u> |
|----------------------------------|-----------------|--------------|--------------------------------|
| (A) Channel Termination          |                 |              |                                |
| . Per Point of Termination T6ECS |                 | \$36.00(I)   | None                           |

(B) Channel Mileage

|               |       | <u>Monthly</u> |              | <u>Rates</u>    |
|---------------|-------|----------------|--------------|-----------------|
|               |       | <u>USOC</u>    | <u>Fixed</u> | <u>Per Mile</u> |
| Mileage Bands |       |                |              |                 |
| 0             | 1L5XX | None           | None         |                 |
| Over 0 to 4   | 1L5XX | \$61.00(I)     |              | \$ 1.25(I)      |
| Over 4 to 8   | 1L5XX | 61.00          |              | 1.25            |
| Over 8 to 25  | 1L5XX | 61.00          |              | 1.25            |
| Over 251      | 1L5XX | 61.00(I)       |              | 1.25(I)         |

(C) Optional Features and Functions

| USOC         | <u>Rates</u>                | <u>Charges</u> | <u>Monthly</u> | <u>Nonrecurring</u> |
|--------------|-----------------------------|----------------|----------------|---------------------|
| (1) Bridging |                             |                |                |                     |
|              | (a) Three Premises Bridging |                |                |                     |
|              | . Per Port BCNM3            | \$ .48         |                | None                |
|              | (b) Series Bridging         |                |                |                     |
|              | Per Port                    | BCNMS \$ .95   |                | None                |

ACCESS SERVICE TARIFF  
PSC No. 2

CINCINNATI BELL TELEPHONE COMPANY

3rd Revised Page 346  
Cancels 2nd Revised Page 346

7. Special Access Service (Cont'd)

7.5 Rates and Charges (Cont'd)

7.5.2 Telegraph Grade Service

|  | <u>Monthly</u> | <u>Rates</u> | <u>Nonrecurring</u> |
|--|----------------|--------------|---------------------|
|  |                |              | <u>Charges</u>      |
| (A) Channel Termination - Per Point of Termination |                |              |                     |
| - Two-Wire   | T6E2X          | \$35.00(I)   | None                |
| - Four-Wire  | T6E4X          | 49.60(I)     | None                |

(B) Channel Mileage

|               | <u>USOC</u> | <u>Monthly Rates</u> |                 |
|---------------|-------------|----------------------|-----------------|
|               |             | <u>Fixed</u>         | <u>Per Mile</u> |
| Mileage Bands |             |                      |                 |
| 0             | 1L5XX       | None                 | None            |
| Over 0 to 4   | 1L5XX       | \$61.00(I)           | \$1.25(R)       |
| Over 4 to 8   | 1L5XX       | 61.00                | 1.25            |
| Over 8 to 25  | 1L5XX       | 61.00                | 1.25            |
| Over 25       | 1L5XX       | 61.00(I)             | 1.25(R)         |

(C) Optional Features and Functions

|   | <u>USOC</u> | <u>Monthly</u> | <u>Nonrecurring</u> |
|---|-------------|----------------|---------------------|
|   |             | <u>Rates</u>   | <u>Charges</u>      |
| (1) Telegraph Bridging Two-Wire and Four-Wire |             |                |                     |
| Per port                                      |             |                |                     |
| Two-Wire                                      | BCNT2       | \$ .48         | None                |
| Four-Wire                                     | BCNT4       | .95            | None                |

ACCESS SERVICE TARIFF  
PSCK No. 2

CINCINNATI BELL TELEPHONE COMPANY

3rd Revised Page 347  
Cancels 2nd Revised Page 347

7. Special Access Service (Cont'd)

7.5 Rates and Charges (Cont'd)

7.5.3 Voice Grade Service

|                             | <u>Monthly</u><br><u>USOC</u> | Nonrecurring<br>Rates | <u>Charges</u> |
|-----------------------------|-------------------------------|-----------------------|----------------|
| (A) Channel Termination     |                               |                       |                |
| (1) Voice Grade             |                               |                       |                |
| Per Point of Termination    |                               |                       |                |
| - Two-Wire                  | T6E2X                         | \$31.00(R)            | None           |
| - Four-Wire                 | T6E4X                         | 49.60(R)              | None           |
| (2) WATS Access Line (WAL)  |                               |                       |                |
| - Per Point of Termination* |                               |                       |                |
| - Two-Wire                  | <del>X2W</del>                | See T6E2X             |                |
| - Four-Wire                 | <del>X4W</del>                | See T6E4X             |                |
| (B) Channel Mileage         |                               |                       |                |
|                             | <u>USOC</u>                   | <u>Monthly Rates</u>  |                |
|                             |                               | Fixed                 | Per Mile       |
| Mileage Bands               |                               |                       |                |
| 0                           | 1L5XX                         | None                  | None           |
| Over 0 to 4                 | 1L5XX                         | \$61.00(I)            | \$1.25(I)      |
| Over 4 to 8                 | 1L5XX                         | 61.00                 | 1.25           |
| Over 8 to 25                | 1L5XX                         | 61.00                 | 1.25           |
| Over 25                     | 1L5XX                         | 61.00(I)              | 1.25(I)        |

One Channel Termination applies per WAL



ACCESS SERVICE TARIFF  
PSCK No. 2

CINCINNATI BELL TELEPHONE COMPANY

2nd Revised Page 348  
Cancels 1st Revised Page 348

7. Special Access Service (Cont'd)

7.5 Rates and Charges (Cont'd)

7.5.3 Voice Grade Service

|                                     | <u>USOC</u> | <u>Monthly Rates</u> | <u>Nonrecurring Charges</u> |
|-------------------------------------|-------------|----------------------|-----------------------------|
| (C) Optional Features and Functions |             |                      |                             |

(1) Bridging

(a) Voice and WAL Bridging

Two-Wire/Four-Wire

- Per port

|             |       |           |      |
|-------------|-------|-----------|------|
| - Two-Wire  | BCNV2 | \$1.41(I) | None |
| - Four-Wire | BCNV4 | 2.51(I)   | None |

(b) Data Bridging

Two-Wire/Four-Wire

- Per port

|             |       |         |      |
|-------------|-------|---------|------|
| - Two-Wire  | BCND2 | 4.70(R) | None |
| - Four-Wire | BCND4 | 1.41(R) | None |

(c) Telephoto Bridging

Two-Wire/Four-Wire

- Per port

|             |       |        |      |
|-------------|-------|--------|------|
| - Two-Wire  | BCNF2 | .48(R) | None |
| - Four-Wire | BCNF4 | .95(R) | None |

(d) DATAPHONE Select-A-Station Bridging

Sequential Arrangement Ports

- Per 2-wire channel connected DQ2

ICB None

- Per 4-wire channel connected DQ4

ICB PUBLIC SERVICE COMMISSION OF KENTUCKY EFFECTIVE

MAY 23 1995

PURSUANT TO 807 KAR 5:011,  
SECTION 9(1)

BY: Jordan C. Neal

Issued: June 13, 1995

Effective: May 23, 1995

*Deborah A. Nisch* President, Cincinnati, Ohio

Vice President  
Integrated Corporate Planning for

ACCESS SERVICE TARIFF  
PSC No. 2

CINCINNATI BELL TELEPHONE COMPANY

1st Revised Page 349  
Cancels Original Page 349

7. Special Access Service (Cont'd)

7.5 Rates and Charges (Cont'd)

7.5.3 Voice Grade Service (Cont'd)

|  | <u>USOC</u> | <u>Monthly Rates</u> | <u>Nonrecurring Charaes</u> |
|--|-------------|----------------------|-----------------------------|
| (C) Optional Features and Functions (Cont'd) |             |                      |                             |
| (1) (Reserved)                               |             |                      |                             |
| (d) <u>(Reserved)</u>                        |             |                      |                             |

(D)  
|  
(D)

**PUBLIC SERVICE COMMISSION  
OF KENTUCKY  
EFFECTIVE**

**OCT 26 1992**

**PURSUANT TO 807 KAR 5:011,  
SECTION 9 (1)**

BY: *Charles H. Baker*  
PUBLIC SERVICE COMMISSION MANAGER

Issued: September 24, 1992

Effective: October 26, 1992

*Robert E. Aigmon* for President, Cincinnati, Ohio

Vice President - Regulatory Affairs

ACCESS SERVICE TARIFF  
PSCK No. 2

CINCINNATI BELL TELEPHONE COMPANY

2nd Revised Page 350  
Cancels 1st Revised Page 350

7. Special Access Service (Cont'd)

7.5 Rates and Charges (Cont'd)

7.5.3 Voice Grade Service (Cont'd)

|  | <u>USOC</u> | <u>Monthly Rates</u> | <u>Nonrecurring Charges</u> |
|--|-------------|----------------------|-----------------------------|
| (C) Optional Features and Functions (Cont'd) |             |                      |                             |
| (2) Conditioning                             |             |                      |                             |
| - Per Point of Termination                   |             |                      |                             |
| C - Type                                     | X1CPT       | \$7.43(R)            | None                        |
| Sealing Current                              | 1HBPT       | None                 | None                        |

PUBLIC SERVICE COMMISSION  
OF KENTUCKY  
EFFECTIVE

MAY 23 1995

PURSUANT TO 807 KAR 5:011,  
SECTION 9(1)

BY: Jordan C. Neel  
FOR THE PUBLIC SERVICE COMMISSION

Issued: June 13, 1995

Effective: ~~May~~ 23, 1995

Deborah A. Nisch President, Cincinnati, Ohio

Vice President  
Integrated Corporate Planning for

ACCESS SERVICE TARIFF  
PSC No. 2

CINCINNATI BELL TELEPHONE COMPANY

2nd Revised Page 351  
Cancels 1st Revised Page 351

7. Special Access Service (Cont'd)

7.5 Rates and Charges (Cont'd)

7.5.3 Voice Grade Service (Cont'd)

| <u>Monthly Rates</u> | <u>Nonrecurring Charges</u> |  |       |           |          |
|----------------------|-----------------------------|--|-------|-----------|----------|
|                      |                             | (C) Optional Features and Functions (Cont'd) |       |           |          |
|                      |                             | (3) Improved Termination                     |       |           |          |
|                      |                             | - Per point of termination                   |       |           |          |
|                      |                             | - Four-Wire                                  | 1RL4W | \$7.84(R) | None     |
|                      |                             | (4) Improved Return Loss                     |       |           |          |
|                      |                             | - Per point of termination                   |       |           |          |
|                      |                             | - Two-Wire                                   | 1RL2W | 4.17(R)   | None     |
|                      |                             | (5) Customer Specified Receive Level         |       |           |          |
|                      |                             | - Per two-wire point of termination          | RLS   | None      | None     |
|                      |                             | (6) Data Capability                          |       |           |          |
|                      |                             | - Per point of termination                   | XDCPT | .74(R)    | None (R) |
|                      |                             | (7) Telephoto Capability                     |       |           |          |
|                      |                             | - Per point of termination                   | XTCPT | 1.61(R)   | None (R) |

PUBLIC SERVICE COMMISSION  
OF KENTUCKY  
EFFECTIVE

MAY 23 1995

PURSUANT TO 807 KAR 5:011,  
SECTION 9 (1)

BY: Jordan C. Neal  
FOR THE PUBLIC SERVICE COMMISSION

Issued: June 13, 1995

Effective: May 23, 1995

*Deborah A. Nisch* President, Cincinnati, Ohio  
Vice President  
Integrated Corporate Planning for

ACCESS SERVICE TARIFF  
PSC No. 2

CINCINNATI BELL TELEPHONE COMPANY

2nd Revised Page 352  
Cancels 1st Revised Page 352

7. Special Access Service (Cont'd)

7.5 Rates and Charges (Cont'd)

7.5.3 Voice Grade Service (Cont'd)

|  | <u>USOC</u> | <u>Monthly Rates</u> | <u>Nonrecurring Charges</u> |
|--|-------------|----------------------|-----------------------------|
| (C) Optional Features and Functions (Cont'd) |             |                      |                             |

(8) Signaling Capability

- Per point of termination **XSS++** \$10.46 (R) None
- In lieu of ++, substitute appropriate two digit code from following list to specify type of signaling.

AB  
AC  
CT  
DX  
DY  
EA  
EB  
EC  
Ex  
GO  
GS  
LA  
LB  
LC  
LO  
LR  
LS  
RV  
SF

PUBLIC SERVICE COMMISSION  
OF KENTUCKY  
EFFECTIVE

MAY 23 1995

PURSUANT TO 807 KAR 5:011,  
SECTION 9(1)

BY: Jordan C. Noel  
FOR THE PUBLIC SERVICE COMMISSION

Issued: June 13, 1995

Effective: **May** 23, 1995

*Deborah A. Nisch* President, Cincinnati, Ohio  
Vice President  
Integrated Corporate Planning for

ACCESS SERVICE TARIFF  
PSCK No. 2

CINCINNATI BELL TELEPHONE COMPANY

1st Revised Page 353  
Cancels Original Page 353

7. Special Access Service (Cont'd)

7.5 Rates and Charges (Cont'd)

7.5.3 Voice Grade Service (Cont'd)

|  | <u>USOC</u> | <u>Monthly Rates</u> | <u>Nonrecurring Charges</u> |
|--|-------------|----------------------|-----------------------------|
| (C) Optional Features and Functions (Cont'd) |             |                      |                             |
| (9) (Reserved)                               |             |                      | (D)                         |
| (10) (Reserved)                              |             |                      | (D)                         |

PUBLIC SERVICE COMMISSION  
OF KENTUCKY  
EFFECTIVE

OCT 26 1992

PURSUANT TO 807 KAR 5:011,  
SECTION 9 (1)

Issued: September 24, 1992

Effective October 26, 1992  
PUBLIC SERVICE COMMISSION MANAGER

*Robert E. Aigman* for President, Cincinnati, Ohio

Vice President - Regulatory Affairs

ACCESS SERVICE TARIFF  
 PSCK No. 2

CINCINNATI TEL., TELEPHONE COMPANY

2nd Revised Page 354  
 Cancels 1st Revised Page 354

7. Special Access Service (Cont'd)

7.5 Rates and Charges (Cont'd)

7.5.4 Program Audio Service

|                                | USOC  | Monthly<br>Rates | Daily*<br>Rates | Nonrecurring<br>Charges |         |
|--------------------------------|-------|------------------|-----------------|-------------------------|---------|
|                                |       |                  |                 | Monthly                 | Daily   |
| (A) <u>Channel Termination</u> |       |                  |                 |                         |         |
| - Per Point of Termination     |       |                  |                 |                         |         |
| - 200 to 3500 Hz               | T6ECS | \$ 25.94(R)      | \$ 2.59(R)      | None(R)                 | None(R) |
| - 100 to 5000 Hz               | T6ECS | 39.02(R)         | 3.90(R)         | Rcme                    | None    |
| - 50 to 8000 Hz                | T6ECS | 48.20(I)         | 4.82(I)         | Rcme                    | None    |
| - 50 to 15000 Hz               | T6ECS | 119.86(R)        | 14.26(R)        | None(R)                 | None(R) |

\* Daily rates will be topped and maximum rates derived as set forth in 7.4.1(B) preceding.

PUBLIC SERVICE COMMISSION  
 OF KENTUCKY  
 EFFECTIVE

MAY 23 1995

PURSUANT TO 807 KAR 5:011,  
 SECTION 9(1)

BY: Jordan C. Neel  
 FOR THE PUBLIC SERVICE COMMISSION

Issued: June 13, 1995

Effective: May 23, 1995

*Deborah A. Nisch* President, Cincinnati, Ohio  
 Vice President  
 Integrated Corporate Planning for

ACCESS SERVICE TARIFF  
PSCK No. 2

CINCINNATI BELL TELEPHONE COMPANY

2nd Revised Page 355  
Cancels 1st Revised Page 355

7. Special Access Service (Cont'd)

7.5 Rates and Charges (Cont'd)

7.5.4 Program Audio Service

(B) Channel Mileane

|                      | USOC  | Monthly Rates |           | Daily Rates* |          |
|----------------------|-------|---------------|-----------|--------------|----------|
|                      |       | Fixed         | Per Mile  | Fixed        | Per Mile |
| (1) 200 to 3500 Hz   |       |               |           |              |          |
| <u>Mileage Bands</u> |       |               |           |              |          |
| 0                    | 1L5XX | None          | None      | None         | None     |
| Over 0 to 4          | 1L5XX | \$58.03(I)    | \$1.57(R) | \$5.80(I)    | \$.16(R) |
| Over 4 to 8          | 1L5XX | 50.03         | 1.57      | 5.80         | .16      |
| Over 8 to 25         | 1L5XX | 58.03         | 1.57      | 5.80         | .16      |
| Over 25              | 1L5XX | 58.03(I)      | 1.57(R)   | 5.80(I)      | .16(R)   |

(2) 100 to 5000 Hz

|                      | 1L5XX | None      | None    | None     | None   |
|----------------------|-------|-----------|---------|----------|--------|
| <u>Mileage Bands</u> |       |           |         |          |        |
| 0                    | 1L5XX | None      | None    | None     | None   |
| Over 0 to 4          | 1L5XX | 116.05(I) | 2.60(I) | 11.61(I) | .26(I) |
| Over 4 to 8          | 1L5XX | 116.05    | 2.60    | 11.6     | .26    |
| Over 8 to 25         | 1L5XX | 116.05    | 2.60    | 11.6     | .26    |
| Over 25              | 1L5XX | 116.05(I) | 2.60(I) | 11.61(I) | .26(I) |

\* Daily rates will be topped and maximum rates derived as set forth in 7.4.1(B) preceding.

PUBLIC SERVICE COMMISSION  
OF KENTUCKY  
EFFECTIVE

MAY 23 1995

PURSUANT TO 807 KAR 5.011,  
SECTION 9 (1)

BY: Jordan C. Neal

~~Issued: June 13, 1995~~

~~Effective: May 23, 1995~~

*Deborah A. Nisich* President, Cincinnati, Ohio

Vice President  
Integrated Corporate Planning for



ACCESS SERVICE TARIFF  
PSCK No. 2

CINCINNATI BELL TELEPHONE COMPANY

2nd Revised Page 356  
Cancels 1st Revised Page 356

7. Special Access Service (Cont'd)

7.5 Rates and Charges (Cont'd)

7.5.4 Program Audio Service (Cont'd)

(B) Channel Mileage (Cont'd)

|                      | USOC  | Monthly Rates |           | Daily Rates* |           |      |
|----------------------|-------|---------------|-----------|--------------|-----------|------|
|                      |       | Fixed         | Per Mile  | Fixed        | Per Mile  |      |
| (3) 50 to 8000 Hz    |       |               |           |              |           |      |
| <u>Mileage Bands</u> |       |               |           |              |           |      |
| 0                    | 1L5XX | None          | None      | None         | None      | None |
| Over 0 to 4          | 1L5XX | \$174.08(R)   | \$3.78(R) | \$17.41(R)   | \$ .38(R) |      |
| Over 4 to 8          | 1L5XX | 174.08        | 3.78      | 17.41        | .38       |      |
| Over 8 to 25         | 1L5XX | 174.08        | 3.78      | 17.41        | .38       |      |
| Over 25              | 1L5XX | 174.08(R)     | 3.78(R)   | 17.41(R)     | .38(R)    |      |

(4) 50 to 15000 Hz

| <u>Mileage Bands</u> |       |           |         |          |        |      |
|----------------------|-------|-----------|---------|----------|--------|------|
| 0                    | 1L5XX | None      | None    | None     | None   | None |
| Over 0 to 4          | 1L5XX | 348.14(I) | 4.39(R) | 34.81(I) | .44(R) |      |
| Over 4 to 8          | 1L5XX | 348.14    | 4.39    | 34.81    | .44    |      |
| Over 8 to 25         | 1L5XX | 348.14    | 4.39    | 34.81    | .44    |      |
| Over 25              | 1L5XX | 348.14(I) | 4.39(R) | 34.81(I) | .44(R) |      |

\* Daily rates will be topped and maximum rates derived as set forth in 7.4.1(B) preceding.

PUBLIC SERVICE COMMISSION  
OF KENTUCKY  
EFFECTIVE

MAY 23 1995

PURSUANT TO 807 KAR 5:011,  
SECTION 9(1)

BY: Jordan C. Neel  
FOR THE PUBLIC SERVICE COMMISSION

Issued: June 13, 1995

Effective: May 23, 1995

*Deborah A. Nisch*  
President, Cincinnati, Ohio  
Vice President  
Integrated Corporate Planning for

ACCESS SERVICE TARIFF  
PSCK No. 2

CINCINNATI BELL TELEPHONE COMPANY

2nd Revised Page 357  
Cancels 1st Revised Page 357

7. Special Access Service (Cont'd)

7.5 Rates and Charges (Cont'd)

7.5.4 Program Audio Service (Cont'd)

(C) Optional Features and Functions

|   | USOC  | Monthly<br>Rates | Daily*<br>Rates | Nonrecurring<br>Charges |          |
|---|-------|------------------|-----------------|-------------------------|----------|
|   |       |                  |                 | Monthly                 | Daily    |
| (1) Bridging<br>(Distribution<br>Amplifier)<br>- Per port | BCNPT | ICB              | ICB             | None                    | None     |
| (2) Gain Conditioning<br>- Per service                    | XGC   | \$10.77(R)       | \$1.08(R)       | None (R)                | None (R) |
| (3) Stereo<br>- Per service                               | XSC   | None             | None            | None (R)                | None (R) |

\* Daily rates will be topped and maximum rates derived as set forth in 7.4.1(B) preceding.

PUBLIC SERVICE COMMISSION  
OF KENTUCKY  
EFFECTIVE

MAY 23 1995

PURSUANT TO 807 KAR 5.011,  
SECTION 9 (1)

BY: Jordan C. Neal  
FOR THE PUBLIC SERVICE COMMISSION

Issued: June 13, 1995

Effective: May 23, 1995

  
Deborah A. Niseth, President, Cincinnati, Ohio  
Vice President  
Integrated Corporate Planning for



ACCESS SERVICE TARIFF  
 PSCK No. 2

CINCINNATI BELL TELEPHONE COMPANY

3rd Revised Page 359  
 Cancels 2nd Revised Page 359

7. Special Access Service (Cont'd)

7.5 Rates and Charges (Cont'd)

7.5.8 Digital Data Service (Cont'd)

|                      | <u>USOC</u> | <u>Monthly Rates</u> |                 |
|----------------------|-------------|----------------------|-----------------|
|                      |             | <u>Fixed</u>         | <u>Per Mile</u> |
| (C) Channel Mileage  |             |                      |                 |
| (1) 2.4 kbps         |             |                      |                 |
| <u>Mileage Bands</u> |             |                      |                 |
| 0                    | 1L5XX       | None                 |                 |
| Over 0 to 4          | 1L5XX       | \$61.00(I)           |                 |
| Over 4 to 8          | 1L5XX       | 61.00                | 1.04            |
| Over 8 to 25         | 1L5XX       | 61.00                | 1.04            |
| Over 25              | 1L5XX       | 61.00(I)             | 1.04(I)         |
| (2) 4.8 kbps         |             |                      |                 |
| <u>Mileage Bands</u> |             |                      |                 |
| 0                    | 1L5XX       | None                 |                 |
| Over 0 to 4          | 1L5XX       | 61.00(I)             |                 |
| Over 4 to 8          | 1L5XX       | 61.00                |                 |
| Over 8 to 25         | 1L5XX       | 61.00                |                 |
| Over 25              | 1L5XX       | 61.00(I)             |                 |
| (3) 9.6 kbps         |             |                      |                 |
| <u>Mileage Bands</u> |             |                      |                 |
| 0                    | 1L5XX       | None                 |                 |
| Over 0 to 4          | 1L5XX       | 61.00(I)             |                 |
| Over 4 to 8          | 1L5XX       | 61.00                |                 |
| Over 8 to 25         | 1L5XX       | 61.00                |                 |
| Over 25              | 1L5XX       | 61.00(I)             |                 |

ACCESS SERVICE TARIFF  
PSC No. 2

CINCINNATI BELL TELEPHONE COMPANY

3rd Revised Page 360  
Cancels 2nd Revised Page 360

7. Special Access Service (Cont'd)

7.5 Rates and Charges (Cont'd)

7.5.8 Digital Data Service (Cont'd)

| (C) Channel Mileage (Cont'd) | usoc | <u>Fixed</u> | <u>Monthly Rates</u><br>Per <u>Mile</u>                           |       |             |            |
|------------------------------|------|--------------|---|-------|-------------|------------|
| (4) 19.2 kbps                |      |              |   |       | (N)         |            |
|                              |      |              | Monthly, Optional Payment Plan and<br>Discount Commitment Program |       |             |            |
|                              |      |              | <u>Mileage Bands</u>  |       |             |            |
|                              |      |              | 0   | 1L5XX | None        | None       |
|                              |      |              | Over 0 to 4   | 1L5XX | \$61.00     | \$1.04     |
|                              |      |              | Over 4 to 8   | 1L5XX | 61.00       | 1.04       |
|                              |      |              | Over 8 to 25  | 1L5XX | 61.00       | 1.04       |
|                              |      |              | Over 25   | 1L5XX | 61.00       | 1.04       |
|                              |      |              |   |       |             | (N)        |
| (5) 56 kbps                  |      |              |   |       |             |            |
|                              |      |              | Monthly, Optional Payment Plan and<br>Discount Commitment Program |       |             |            |
|                              |      |              | <u>Mileage Bands</u>  |       |             |            |
|                              |      |              | 0   | 1L5XX | None        | None       |
|                              |      |              | Over 0 to 4   | 1L5XX | \$61.00 ( ) | \$1.04 (I) |
|                              |      |              | Over 4 to 8   | 1L5XX | 61.00       | 1.04       |
|                              |      |              | Over 8 to 25  | 1L5XX | 61.00       | 1.04       |
|                              |      |              | Over 25   | 1L5XX | 61.00 ( )   | 1.04 (I)   |
| (6) 64 kbps                  |      |              |   |       |             |            |
|                              |      |              | Monthly, Optional Payment Plan and<br>Discount Commitment Program |       |             |            |
|                              |      |              | <u>Mileage Bands</u>  |       |             |            |
|                              |      |              | 0   | 1L5XX | None        | None       |
|                              |      |              | Over 0 to 4   | 1L5XX | 61.00 (I)   | 1.04 (I)   |
|                              |      |              | Over 4 to 8   | 1L5XX | 61.00       | 1.04       |
|                              |      |              | Over 8 to 25  | 1L5XX | 61.00       | 1.04       |
|                              |      |              | Over 25   | 1L5XX | 61.00 (I)   | 1.04 (I)   |

ACCESS SERVICE TARIFF  
PSCK No. 2

CINCINNATI BELL TELEPHONE COMPANY

2nd Revised Page 361  
Cancels 1st Revised Page 361

7. Special Access Service (Cont'd)

7.5 Rates and Charges (Cont'd)

7.5.8 Digital Data Service (Cont'd)

(D) Optional Features and Functions

|   | <u>USOC</u> | <u>Monthly Rates</u> | <u>Nonrecurring Charges</u> |
|---|-------------|----------------------|-----------------------------|
| (1) Bridging<br>- Per port  | BCNDA       | \$ 2.36(R)           | None                        |
| (2) ( <u>Reserved</u> )   |             |                      |                             |
| (3) Secondary Channel<br>Capability,<br>per point of<br>termination | SFS         | None                 | None                        |

PUBLIC SERVICE COMMISSION  
OF KENTUCKY  
EFFECTIVE

MAY 23 1995

PURSUANT TO 807 KAR 5.011,  
SECTION 9 (1)

BY: Jordan C. Neal  
FOR THE PUBLIC SERVICE COMMISSION

Issued: June 13, 1995

Effective: May 23, 1995

 President, Cincinnati, Ohio  
Vice President  
Integrated Corporate Planning for

ACCESS SERVICE TARIFF  
PSCK No. 2

CINCINNATI BELL TELEPHONE COMPANY

3rd Revised Page 362  
Cancels 2nd Revised Page 362

7. Special Access Service (Cont'd)

7.5 Rates and Charges

7.5.9 High Capacity Service

|                            | Monthly<br>USOC | Nonrecurring<br><u>Rates</u> | <u>Charges</u> |
|----------------------------|-----------------|------------------------------|----------------|
| (A) Channel Termination    |                 |                              |                |
| - Per Point of Termination |                 |                              |                |
| - 3.152 Mbps               | TWR++           | ICB                          | None           |
| - 6.312 Mbps               | TWT++           | ICB                          | None           |
| - 274.176 Mbps             | TWT++           | ICB                          | None           |

Recurring Charges-Optional Payment Plan  
and Discount Commitment Program

|                        |             |                |                |                |     |
|------------------------|-------------|----------------|----------------|----------------|-----|
| 1.544 Mbps             |             |                |                |                |     |
| (MercNet 1.5)          | <u>USOC</u> | <u>MONTHLY</u> | <u>36 MOS.</u> | <u>60 MOS.</u> | (C) |
| Zone 1                 | TZGA1       | \$ 135.79      | \$ 129.00      | \$ 122.21      |     |
| Zone 2                 | TZGA2       | \$ 135.79      | \$ 129.00      | \$ 122.21      | (N) |
| Zone 3                 | TZGA3       | \$ 135.79      | \$ 129.00      | \$ 122.21      | (N) |
| MercNET 45             |             |                |                |                |     |
| 1st Chan. Term.        |             |                |                |                |     |
| Zone 1                 | TZGB1       | \$1800.00(R)   | \$1200.00(R)   | \$1000.00(R)   |     |
| Zone 2                 | TZGB2       | \$1800.00      | \$1200.00      | \$1000.00      | (N) |
| Zone 3                 | TZGB3       | \$1800.00      | \$1200.00      | \$1000.00      | (N) |
| 2nd Chan. Term.        |             |                |                |                |     |
| Zone 1                 | TZGC1       | \$1661.00(R)   | \$855.00(R)    | \$676.00(R)    |     |
| Zone 2                 | TZGC2       | \$1661.00      | \$855.00       | \$676.00       | (N) |
| Zone 3                 | TZGC3       | \$1661.00      | \$855.00       | \$676.00       | (N) |
| 3rd Chan. Term.        |             |                |                |                |     |
| Zone 1                 | TZGD1       | \$1637.00(R)   | \$836.00(R)    | \$654.00(R)    |     |
| Zone 2                 | TZGD2       | \$1637.00      | \$836.00       | \$654.00       | (N) |
| Zone 3                 | TZGD3       | \$1637.00      | \$836.00       | \$654.00       | (N) |
| MercNET 45             |             |                |                |                |     |
| 12 Pack Arrangement/CT |             |                |                |                |     |
| Zone 1                 | HZ4P1       | \$1569.95(R)   | \$824.52(R)    | \$650.43(R)    |     |
| Zone 2                 | HZ4P2       | \$1569.95      | \$824.52       | \$650.43       | (N) |
| Zone 3                 | HZ4P3       | \$1569.95      | \$824.52       | \$650.43       | (N) |

Issued: February 23, 1999

Effective: January 25, 1999

President, Cincinnati, Ohio

ACCESS SERVICE TARIFF  
PSC No. 2

CINCINNATI BELL TELEPHONE COMPANY

2nd Revised Page 364  
Cancels 1st Revised Page 364

7. Special Access Service (Cont'd)

7.5 Rates and Charges (Cont'd)

7.5.9 High Capacity Service (Cont'd)

|                                      | <u>USOC</u> | <u>Fixed</u> | <u>Monthly Rates</u><br><u>Per Mile</u> |
|--------------------------------------|-------------|--------------|---|
| (B) Channel Mileage (Cont'd)         |             |              |   |
| (4) 6.312 Mbps                       |             |              |   |
| <u>Mileage Bands</u>                 |             |              |   |
| 0                                    | 1L0++       | None         | None                                    |
| Over 0 to 4                          | 1L0++       | ICB          | ICB                                     |
| Over 4 to 8                          | 1L0++       | ICB          | ICB                                     |
| Over 8 to 25                         | 1L0++       | ICB          | ICB                                     |
| Over 25                              | 1L0++       | ICB          | ICB                                     |
| (5) MercNet 45                       |             |              |   |
| Monthly and<br>Optional Payment Plan |             |              |   |
| <u>Mileage Bands</u>                 |             |              |   |
| (a) <u>Zone 1</u>                    |             |              |   |
| 0                                    | 1YBB1       | None         | None                                    |
| Over 0 to 4                          | 1YBB1       | \$800.00(R)  | \$90.00(R)                              |
| Over 4 to 8                          | 1YBB1       | 800.00       | 90.00                                   |
| Over 8 to 25                         | 1YBB1       | 800.00       | 90.00                                   |
| Over 25                              | 1YBB1       | 800.00(R)    | 90.00(R)                                |
| (b) <u>Zone 2</u>                    |             |              |   |
| 0                                    | 1YBB2       | None         | None                                    |
| Over 0 to 4                          | 1YBB2       | \$800.00     | \$90.00                                 |
| Over 4 to 8                          | 1YBB2       | 800.00       | 90.00                                   |
| Over 8 to 25                         | 1YBB2       | 800.00       | 90.00                                   |
| Over 25                              | 1YBB2       | 800.00       | 90.00                                   |
| (c) <u>Zone 3</u>                    |             |              |   |
| 0                                    | 1YBB3       | None         | None                                    |
| Over 0 to 4                          | 1YBB3       | \$800.00     | \$90.00                                 |
| Over 4 to 8                          | 1YBB3       | 800.00       | 90.00                                   |
| Over 8 to 25                         | 1YBB3       | 800.00       | 90.00                                   |
| Over 25                              | 1YBB3       | 800.00       | 90.00                                   |

(I)  
|  
(N)



ACCESS SERVICE TARIFF  
PSCK No. 2

CINCINNATI BELL TELEPHONE COMPANY

Original Page 365

7. Special Access Service (Cont'd)

7.5 Rates and Charges (Cont'd)

7.5.9 High Capacity Service (Cont'd)

|                              | <u>USOC</u> | <u>Monthly Rates</u> |                 |
|------------------------------|-------------|----------------------|-----------------|
|                              |             | <u>Fixed</u>         | <u>Per Mile</u> |
| (B) Channel Mileage (Cont'd) |             |                      |                 |
| (6) 274.176 Mbps             |             |                      |                 |
| <u>Mileage Bands</u>         |             |                      |                 |
| 0                            | 1L0++       | None                 | None            |
| Over 0 to 4                  | 1L0++       | ICB                  | ICB             |
| Over 4 to 8                  | 1L0++       | ICB                  | ICB             |
| Over 8 to 25                 | 1L0++       | ICB                  | ICB             |
| Over 25                      | 1L0++       | ICB                  | ICB             |

PUBLIC SERVICE COMMISSION  
OF KENTUCKY  
EFFECTIVE

MAR 3 1992

PURSUANT TO 807 KAR 5:011,  
SECTION 9 (1)

BY: *Sharon Keller*

PUBLIC SERVICE COMMISSION MANAGER  
Effective: March 3, 1992

Issued: February 7, 1992

*Robert E. Sigmon* for President, Cincinnati, Ohio

Vice President - Regulatory Affairs

ACCESS SERVICE TARIFF  
PSC No. 2

CINCINNATI BELL TELEPHONE COMPANY

4th Revised Page 366  
Cancels 3rd Revised Page 366

7. Special Access Service (Cont'd)

7.5 Rates and Charges (Cont'd)

7.5.9 High Capacity Service (Cont'd)

|                                     | <u>Monthly</u><br><u>USOC</u> | <u>Nonrecurring</u><br><u>Rates</u> | <u>Charges</u> |
|-------------------------------------|-------------------------------|-------------------------------------|----------------|
| (C) Optional Features and Functions |                               |                                     |                |
| (1) Multiplexing                    |                               |                                     |                |
| DS4 to DS1                          |                               |                                     |                |
| - Per arrangement                   | MXA++                         | ICB                                 | None           |
| DS3 to DS1                          |                               |                                     |                |
| - Per arrangement                   |                               |                                     |                |
| - Zone 1                            | QM3X1                         | \$ 678.02                           | None (C)       |
| - Zone 2                            | QM3X2                         | 678.02                              | None           |
| - Zone 3                            | QH3X3                         | 678.02                              | None           |
| DS2 to DS1                          |                               |                                     |                |
| - Per arrangement                   | MXD++                         | ICB                                 | None           |
| DSL to DS1                          |                               |                                     |                |
| - Per arrangement                   | MXH++                         | ICB                                 | None           |
| DS1 to Voice*                       |                               |                                     |                |
| - Per arrangement                   |                               |                                     |                |
| - Zone 1                            | QMVX1                         | \$ 285.45                           | None           |
| - Zone 2                            | QMVX2                         | 285.45                              | None           |
| - Zone 3                            | QMVX3                         | 285.45                              | None           |
| DS1 to Digital Data**               |                               |                                     |                |
| - Per arrangement                   |                               |                                     |                |
| - Zone 1                            | QMKX 1                        | 285.45                              | None           |
| - Zone 2                            | QMKX2                         | 285.45                              | None           |
| - Zone 3                            | QMKX3                         | 285.45                              | None           |

\* A channel(s) of this DS1 to the Hub can be used for Program Audio, Metallic or WATS Access Line Services.

\*\* A channel of this DS1 to the Hub can be used for Digital Data with or without Secondary Channel Capability, Voice Grade, Program Audio, Metallic or WATS Access Line Services.

Issued: March 25, 1999

Effective: January 25, 1999

President, Cincinnati, Ohio

ACCESS SERVICE TARIFF  
PSCK No. 2

CINCINNATI BELL TELEPHONE COMPANY

2nd Revised Page 367  
Cancels 1st Revised Page 367

7. Special Access Service (Cont'd)

7.5 Rates and Charges (Cont'd)

7.5.9 High Capacity Service (Cont'd)

|  | <u>USOC</u> | <u>Monthly Rates</u> | <u>Nonrecurring Charges</u> |
|--|-------------|----------------------|-----------------------------|
| (C) Optional Features and Functions (Cont'd) |             |                      |                             |
| (1) Multiplexing (Cont'd)                    |             |                      |                             |
| DS1 to DS0*                                  |             |                      |                             |
| - Per arrangement                            | QMU         | \$195.79(I)          | None                        |
| DS0 to Subrates*                             |             |                      |                             |
| - Per arrangement                            |             |                      |                             |
| - Up to 20 2.4 kbps services                 | QSU24       | 61.49(R)             | None                        |
| - Up to 10 4.8 kbps services                 | QSU48       | 36.10(R)             | None                        |
| - Up to 5 9.6 kbps services                  | QSU96       | 23.40(R)             | None                        |

PUBLIC SERVICE COMMISSION  
OF KENTUCKY  
EFFECTIVE

MAY 23 1995

PURSUANT TO 807 KAR 5.011,  
SECTION 9(1)

BY: Jordan C. Neel  
FOR THE PUBLIC SERVICE COMMISSION

\* This arrangement can be provided with the Secondary Channel Capability feature of Digital Data Service.

Issued: June 13, 1995

Effective: **May** 23, 1995

*Deborah A. Nisch* President, Cincinnati, Ohio  
Vice President  
Integrated Corporate Planning for

ACCESS SERVICE TARIFF  
PSC No. 2

CINCINNATI BELL TELEPHONE COMPANY

3rd Revised Page 368  
Cancels 2nd Revised Page 368

7. Special Access Service (Cont'd)

7.5 Rates and Charges (Cont'd)

7.5.9 High Capacity Service (Cont'd)

|  | <u>USOC</u> | <u>Monthly Rates</u> | <u>Nonrecurring Charges</u> |
|--|-------------|----------------------|-----------------------------|
| (C) Optional Features and Functions (Cont'd)       |             |                      |                             |
| (2) Alternate Central Office Channel               |             |                      |                             |
| - Per 1.544 Mbps High Capacity                     |             |                      |                             |
| - Zone 1   | AVXA1       | \$ 71.30             | None                        |
| - Zone 2   | AVXA2       | \$ 71.30             | None (N)                    |
| - Zone 3   | AVXA3       | \$ 71.30             | None (N)                    |
| - Per 45 Mbps High Capacity                        |             |                      |                             |
| - Zone 1   | AVXB1       | \$200.00             | None                        |
| - Zone 2   | AVXB2       | \$200.00             | None (N)                    |
| - Zone 3   | AVXB3       | \$200.00             | None (N)                    |
| (3) Service To Service Through Connect Arrangement |             |                      |                             |
| - Per 1.544 Mbps High Capacity                     |             |                      |                             |
|  | STMLX       | None                 | None                        |
| (4) Clear Channel Capability                       |             |                      |                             |
| - Per High Capacity channel termination            |             |                      |                             |
|  | CLR         | 0.00                 | None                        |
| (5) Interoffice Access Diversity (EAD)             |             |                      |                             |
| - Per 1.544 Mbps or 45 Mbps High Capacity          |             |                      |                             |
| - Zone 1   | DZQX1       | 12.00                | None                        |
| - Zone 2   | DZQX2       | 12.00                | None (N)                    |
| - Zone 3   | DZQX3       | 12.00                | None (N)                    |

Issued: February 23, 1999

Effective: January 25, 1999

President, Cincinnati, Ohio

ACCESS SERVICE TARIFF  
PSC No. 2

CINCINNATI BELL TELEPHONE COMPANY

2nd Revised Page 369  
Cancels 1st Revised Page 369

7. Special Access service (Cont'd)

7.5 Rates and Charges (Cont'd)

7.5.10 Customer Network Reconfiguration Service (CNRS)

|  | <u>USOC</u> | <u>Monthly Rates</u> | <u>Nonrecurring Charge</u> |
|--|-------------|----------------------|----------------------------|
| A. Service Establishment Charge<br>- Per Database Setup  | NRBNS       |                      | None(R)                    |
| B. CNRS Port Charges   |             |                      |                            |
| - DS1 Port   | PT6         | \$77.07(R)           | None(R)                    |
| - DS0 Port   | PT5         | 28.25(R)             | None(R)                    |
| C. Reconfiguration and/or<br>Database Changes Performed<br>by the Telephone Company                    |             |                      |                            |
| - Basic Time, normally<br>scheduled working hours,<br>per half hour or<br>fraction thereof             | NRBNR       |                      | None(R)                    |
| - Overtime, outside of<br>normally scheduled<br>working hours, per<br>half hour or fraction<br>thereof | NRBNO(N)    | -                    | None(R)                    |
| 7.5.11 Special Access Surcharge<br>- Per Surcharge Assessed  | S25++*      | 25.00                |                            |

In lieu of ++, substitute EX for exempt or AP for applicable.

Issued: February 23, 1999

Effective: January 25, 1999

President, Cincinnati, Ohio

ACCESS SERVICE TARIFF  
PSC No. 2

CINCINNATI BELL TELEPHONE COMPANY

Original Page 369.1

7. Special Access Service (Cont'd)

7.5 Rates and Charges (Cont'd)

7.5.12 OC-3 Service, OC-12 Service, and OC-48 Service - Point-to-Point Services

(N)

(A) OC-3 Service

|     |                                  | USOC  | Monthly    | Recurring Charge |            |
|-----|----------------------------------|-------|------------|------------------|------------|
|     |                                  |       |            | 36 Mo.           | 60 Mo.     |
| (1) | Channel Termination              |       |            |                  |            |
|     | - Per Point of Termination       |       |            |                  |            |
|     | Terminating Bit Rate 155.52 Mbps | TMECS | \$1,660.00 | \$1,420.00       | \$1,180.00 |
| (2) | Channel Mileage                  |       |            |                  |            |
|     | Fixed                            | 1L5XX | 630.00     | 535.00           | 500.00     |
|     | Per mile at 155.52 Mbps          | 1L5XX | 245.00     | 210.00           | 200.00     |
| (3) | Optional Features and Functions  |       |            |                  |            |
|     | (a) OC-3 Add/Drop Multiplexing   |       |            |                  |            |
|     | - Per Arrangement                | MXRCX | 1,100.00   | 935.00           | 775.00     |
|     | (b) Add/Drop Function            |       |            |                  |            |
|     | - Per DS3 Add or Drop            | MXJBX | 120.00     |                  |            |
|     | - Per DS1 Add or Drop            | MXJAX | 45.00      |                  |            |

(N)

Issued: February 23, 1999

Effective: January 25, 1999

President, Cincinnati, Ohio

7. Special Access Service (Cont'd)

7.5 Rates and Charges (Cont'd)

7.5.12 OC-3 Service, OC-12 Service, and OC-48 Service - Point-to-Point Services (Cont'd)

(A) OC-3 Service (Cont'd)

(3) Optional Features and Functions (Cont'd)

USOC

Monthly

(c) Cross-Connection of Services OC-3 to OC-3 Cross-Connect  
 Per Circuit

OCCCX

\$100.00

(d) 1+1 Protection with Route Survivability

- Per Quarter  
 Route Mile

S2DXY

50.00

(e) 1+1 Protection with Central Office Survivability

- Per Quarter  
 Route Mile

S2VXY

50.00

- Channel Mileage  
 Fixed and Per Mile

Apply Rates and Charges  
 As 7.5.12A Preceding

(N)

(N)

7. Special Access Service (Cont'd)

7.5 Rates and Charges (Cont'd)

7.5.12 OC-3 Service, OC-12 Service, and OC-48 Service - Point-to-Point Services

(B) OC-12 Service

|   | <u>USOC</u> | Recurring Charge<br>Optional Payment Plan |               |               |
|---|-------------|---|---------------|---------------|
|   |             | <u>Monthly</u>                            | <u>36 Mo.</u> | <u>60 Mo.</u> |
| (1) Channel Termination<br>Per Point of<br>Termination<br>Terminating Bit<br>Rate 622.08 Mbps | TMECS       | \$3,410.00                                | \$2,926.00    | \$2,445.00    |
| (2) Channel Mileage<br>- Fixed  | 1L5XX       | 935.00                                    | 795.00        | 750.00        |
| - Per mile at<br>622.08 Mbps  | 1L5XX       | 495.00                                    | 420.00        | 400.00        |
| (3) Optional Features and Functions   |             |   |               |               |
| (a) OC-12<br>Add/Drop<br>- Per Multiplexing<br>Arrangement                                    | MXRDX       | 2,460.00                                  | 2,092.00      | 1,720.00      |
| (b) Add/Drop Function   |             |   |               |               |
| - Per DS3<br>Add or Drop  | MXJBX       | 150.00                                    |               |               |
| - Per DS1<br>Add or Drop  | MXJBX       | 120.00                                    |               |               |

)

(N)



7. Special Access Service (Cont'd)

7.5 Rates and Charges (Cont'd)

7.5.12 OC-3 Service, OC-12 Service, and OC-48 Service - Point-to-Point Services (Cont'd) (N)

(B) OC-12 Service (Cont'd)

|     |   |       |   |     |
|-----|---|-------|---|-----|
| (3) | <u>Optional Features and Functions</u> (Cont'd)   | USOC  | <u>Monthly</u>                                  |     |
|     | (c) <u>Cross-Connection of Services</u><br>oc-12 to oc-12<br>Cross-Connect<br>Per Circuit | CCCDX | \$545.00  |     |
|     | (d) <u>1+1Protection with Route Survivability</u>   |       |   |     |
|     | - Per Quarter<br>Route Mile   | S2DXY | 50.00   |     |
|     | (e) <u>1+1Protection with Central Office Survivability</u>                                |       |   |     |
|     | - Per Quarter<br>Route Mile   | S2VXY | 50.00   |     |
|     | - Channel Mileage<br>Fixed and Per Mile   |       | Apply Rates and Charges<br>As 7.5.12B Preceding | (N) |

ACCESS SERVICE TARIFF  
 PSCK No. 2

CINCINNATI BELL TELEPHONE COMPANY

Original Page 369.5

7. Special Access Service (Cont'd)

7.5 Rates and Charges (Cont'd)

7.5.12 OC-3 Service, OC-12 Service, and OC-48 Service - Point-to-Point Services

(C) OC-48 Service

|  | USOC  | Monthly    | Recurring Charge<br>Optional Payment Plan |            |
|--|-------|------------|---|------------|
|  |       |            | 36 Mo.                                    | 60 Mo.     |
| (1) Channel Termination                                    |       |            |   |            |
| Per Point of Termination Terminating Bit Rate 2488.32 Mbps | TMECS | \$9,170.00 | \$7,970.00                                | \$6,770.00 |
| (2) Channel Mileage  |       |            |   |            |
| - Fixed  | 1L5XX | 2,100.00   | 1,890.00                                  | 1,785.00   |
| - Per mile at 2488.32 Mbps                                 | 1L5XX | 545.00     | 515.00                                    | 440.00     |
| (3) Optional Features and Functions                        |       |            |   |            |
| (a) OC-48 Add/Drop Multiplexing                            |       |            |   |            |
| - Per Arrangement (not to exceed 12 DS3s or equivalent)    | MXRFX | 1,370.00   | 1,165.00                                  | 960.00     |
| (b) Add/Drop Function                                      |       |            |   |            |
| - Per OC-12 Add or Drop                                    | MXJEX | 375.00     |   |            |
| - Per OC-3 Add or Drop                                     | MXICX | 150.00     |   |            |
| - Per DS3 Add or Drop                                      | MXJBX | 120.00     |   |            |

↓)

(N)

Issued: February 23, 1999

Effective: January 25, 1999

President, Cincinnati, Ohio

7. Special Access Service (Cont'd)

7.5 Rates and Charges (Cont'd)

7.5.12 OC-3 Service, OC-12 Service, and OC-48 Service - Point-to-Point Services (Cont'd)

(C) OC-48 Service (Cont'd)

| (3) <u>Optional Features and Functions</u> (Contd)                                 | USOC  | <u>Monthly</u>                                  | I)  |
|--|-------|---|-----|
| (c) Cross-Connection of Services<br>OC-48 to OC-48<br>Cross-Connect<br>Per Circuit | OCCFX | \$1,095.00                                      |     |
| (d) 1+1 Protection with Route Survivability  |       |   |     |
| - Per Quarter<br>Route Mile  | S2DXY | 50.00   |     |
| (e) 1+1 Protection with Central Office Survivability                               |       |   |     |
| - Per Quarter<br>Route Mile  | S2VXY | 50.00   |     |
| - Channel Mileage<br>Fixed and Per Mile  |       | Apply Rates and Charges<br>As 7.5.12C Preceding |     |
| (f) Point-to-Point<br>OC-48 Regenerator  |       |   |     |
| - Each (as required)   | RGY4B | 5,270.00  | (N) |

ACCESS SERVICE TARIFF  
PSC No. 2

CINCINNATI BELL TELEPHONE COMPANY

Original Page 369.7

7. Special Access Service (Cont'd)

7.5 Rates and Charges (Cont'd)

7.5.13 OC-3 Service, OC-12 Service, and OC-48 Service - Dedicated Ring (N)

(A) Node

|                   | USOC  | 36 Mo.     | 60 Mo.     |
|-------------------|-------|------------|------------|
| Per Node Type     |       |            |            |
| OC-3              |       |            |            |
| Customer Premises | FP5CX | \$1,765.00 | \$1,410.00 |
| Central Office    | FC5CX | 1,000.00   | 800.00     |
| OC-12             |       |            |            |
| Customer Premises | FP5DX | 3,076.00   | 2,460.00   |
| Central Office    | FC5DX | 2,501.00   | 1,885.00   |
| OC-48             |       |            |            |
| Customer Premises | FP5EX | 5,885.00   | 4,710.00   |
| Central Office    | FC5EX | 5,240.00   | 4,190.00   |

(B) OC-48 Add/Drop Capability

|   |       |          |        |     |
|---|-------|----------|--------|-----|
| Per Arrangement<br>(not to exceed 12<br>DS3s or equivalent) |       |          |        |     |
|   | MPEFX | 1,165.00 | 960.00 | (N) |



7. Special Access Service (Cont'd)

7.5 Rates and Charges (Cont'd)

7.5.13 OC-3 Service, OC-12 Service, and OC-48 Service  
Dedicated Ring (Cont'd)

(N)

(F) Dedicated Ring  
 Regenerator

|                    | USOC | <u>36 Mo.</u> | <u>60 Mo.</u> |     |     |
|--------------------|------|---------------|---------------|-----|-----|
| OC-3               |      |               |               |     |     |
| Each (as required) | RGY  | \$1,000.00    | \$ 800.00     |     |     |
| oc-12              |      |               |               |     |     |
| Each (as required) | RGY  | 2,620.00      | 2,095.00      |     |     |
| OC-48              |      |               |               |     |     |
| Each (as required) | RGY  | 3,275.00      | 2,620.00      | (N) | (C) |

7. Special Access Service (Cont'd)

7.5 Rates and Charges (Cont'd)

7.5.14 Shared SONET Service

|     |   | <u>USOC</u> | <u>Monthly Rates</u> | <u>Recurring Charges</u> |                     |     |
|-----|---|-------------|----------------------|--------------------------|---------------------|-----|
|     |   |             |                      | <u>Optional</u>          | <u>Payment Plan</u> |     |
|     |   |             |                      | <u>36. Mo</u>            | <u>60 Mo.</u>       |     |
| (A) | Network Access Connection (NAC)         |             |                      |                          |                     |     |
|     | - Per DS1 Customer Premises Termination | NYALX       | \$ 157.00            | \$118.00                 | \$105.00            |     |
|     | - Per DS3 Customer Premises Termination | NYA3X       | \$1,193.00           | \$895.00                 | \$795.00            |     |
| (B) | Off-Network Access Connection (ONAC)    |             |                      |                          |                     |     |
|     | - Per DS1 Central Office Connection     | NY01X       | \$90.00              | \$ 50.00                 | \$ 35.00            |     |
|     | - Per DS3 Central Office Connection     | NY03X       | \$ 108.00            | \$ 65.00                 | \$ 55.00            |     |
|     | - Per OC-3 Central Office Connection    | NYOAX       | \$ 444.00            | \$335.00                 | \$295.00            |     |
|     | - Per OC-12 Central Office Connection   | NYOBX       | \$ 750.00            | \$580.00                 | \$550.00            | (N) |

ACCESS SERVICE TARIFF  
 PSCK No. 2

CINCINNATI BELL TELEPHONE COMPANY

Original Page 369.11

7. Special Access Service (Cont'd)

7.5 Rates and Charges (Cont'd)

7.5.14 Shared SONET Service (Cont'd)

|     |   |             |              | Recurring Charges     |                      | (N) |
|-----|---|-------------|--------------|-----------------------|----------------------|-----|
|     |   | Monthly     |              | Optional Payment Plan |                      |     |
|     |   | <u>USOC</u> | <u>Rates</u> | <u>36. Mb</u>         | <u>60 No.</u>        |     |
| (C) | DS3 Payload Multiplexing Function   |             |              |                       |                      |     |
|     | - Per DS3/STS-1 to/from DS1/Vr1.5 on the network                                  | MPEMX       | \$385.00     | \$325.00              | \$305.00             |     |
|     |   |             |              | <u>USOC</u>           | <u>Monthly Rates</u> |     |
| (D) | Service Area Transport  |             |              |                       |                      |     |
|     | - Per Band on the Network DS1/VT1.5 Point to Point                                |             |              |                       |                      |     |
|     | - up to 3 miles   |             |              | 1Y6AA                 | \$ 52.00             |     |
|     | - greater than 3 miles up to 10 miles   |             |              | 1Y6AB                 | 76.00                |     |
|     | - greater than 10 miles   |             |              | 1Y6AC                 | 108.00               |     |
|     | - Per Band on the Network DS3/STS-1 Point to Point                                |             |              |                       |                      |     |
|     | - up to 3 miles   |             |              | 1Y6BA                 | \$ 728.00            |     |
|     | - greater than 3 miles up to 10 miles   |             |              | 1Y6BB                 | 1,064.00             |     |
|     | - greater than 10 miles   |             |              | 1Y6BC                 | 1,512.00             |     |
|     | - Per Band on the Network DS3, OC-3 or OC-12 channelized on a per DS1/Vr1.5 Basis |             |              |                       |                      |     |
|     | - up to 3 miles   |             |              | 1Y6EA                 | \$26.00              |     |
|     | - greater than 3 miles up to 10 Miles   |             |              | 1Y6EB                 | 38.00                |     |
|     | - greater than 10 Miles   |             |              | 1Y6EC                 | 54.00                | (N) |



ACCESS SERVICE TARIFF  
PSCK No. 2

CINCINNATI BELL TELEPHONE COMPANY

1st Revised Page 370  
Cancels Original Page 370

8. Billing and Collection Services

The Telephone Company will provide the following services:

- (A) Recording Service,
- (B) Billing Service,
- (C) Billing Analysis Service, and
- (D) Billing Information Service

8.1 Recording Service

PUBLIC SERVICE COMMISSION,  
OF KENTUCKY  
EFFECTIVE

MAY 23 1995

PURSUANT TO 807 KAR 5:011,  
SECTION 9(1)

BY: Jordan C. Neel  
FOR THE PUBLIC SERVICE COMMISSION

(D)

(D)

The Telephone Company will provide Recording Service in its operating territory. The minimum territory for which the Telephone Company will provide Recording Service is all the appropriately equipped offices in a state operating territory for which the customer has ordered Feature Group D Switched Access Service. A state operating territory of a particular Telephone Company includes all its LATAs or market areas which are located in the same state including the areas in contiguous states which are assigned to such LATAs or market areas and served by the same Telephone Company.

(C)

For Feature Group D Switched Access Service, the term "customer message" used herein denotes a completed intrastate call originated by a customer's end user. A customer message begins when answer supervision from the premise of the ordering customer is received by Telephone Company recording equipment indicating that the called party has answered. A message ends when disconnect supervision is received by Telephone Company recording equipment from either the premise of the ordering customer or the customer's end user premise from which the call originated.

(C)

Issued: June 13, 1995

Effective: May 23, 1995

*Deborah A. Nisch* President, Cincinnati, Ohio  
Vice President  
Integrated Corporate Planning for

ACCESS SERVICE TARIFF  
PSCK No. 2

CINCINNATI BELL TELEPHONE COMPANY

1st Revised Page 371  
Cancels Original Page 371

8. Billing and Collection Services (Cont'd)

8.1 Recording Service (Cont'd)

PUBLIC SERVICE COMMISSION  
OF KENTUCKY  
EFFECTIVE

MAY 23 1995

PURSUANT TO 807 KAR 5:011,  
SECTION 9 (1)

BY: Jordan C. Neel  
FOR THE PUBLIC SERVICE COMMISSION

(D)

(D)

8.1.1 General Description

Recording Service is the recording of the details of a customer message and, when requested by the customer, the provision of those details to the customer. Recording Service includes recording, assembly and editing, and provision of recorded customer message.

Recording is the entering on magnetic tape or other acceptable media the details of customer messages originated through Switched Access Service for which answer and disconnect supervision has been received. Recording is provided 24 hours a day, 7 days a week.

Assembly and editing is the aggregation of the recorded customer message details to create individual messages and the verification that the data required for rating, in accordance with the standard format established by the Telephone Company, is present. Assembly and editing is performed at least once a week.

Issued: June 13, 1995

Effective: **May 23, 1995**

 Deborah A. Nisch, President, Cincinnati, Ohio  
Vice President  
Integrated Corporate Planning for

ACCESS SERVICE TARIFF  
PSCK No. 2

CINCINNATI BELL TELEPHONE COMPANY

1st Revised Page 372  
Cancels Original Page 372

8. Billing and Collection Services (Cont'd)

8.1 Recordinn Service (Cont'd)

8.1.1 General Description (Cont'd)

Provision of customer message detail is the provision of magnetic tapes containing the assembled and edited customer message detail and when requested by the customer, data-transmitting the assembled and edited customer message detail to the customer.

(D)

(D)

Except for lost or damaged records, the recorded detail will be available to the customer according to a **mutually** agreeable schedule.

(C)

(C)

8.1.2 Undertaking of the Telephone Company

PUBLIC SERVICE COMMISSION  
OF KENTUCKY  
EFFECTIVE

- (B) A standard format for the provision of the recorded customer message detail will be established by the Telephone Company and provided to the customer. If, in the course of Telephone Company business, it is necessary to change the format, the Telephone Company will notify the involved customer *six* months prior to the change.

Issued: June 13, 1995

Effective: May 23, 1995

 President, Cincinnati, Ohio  
Vice President  
Integrated Corporate Planning for

ACCESS SERVICE TARIFF  
PSC No. 2

CINCINNATI BELL TELEPHONE COMPANY

1st Revised Page 373  
Cancels Original Page 373

8. Billing and Collection Services (Cont'd)

8.1 Recordinn Service (Cont'd)

8.1.2 Undertakinn of the Telephone Company (Cont'd)

(C)

(D)

PUBLIC SERVICE COMMISSION  
OF KENTUCKY  
EFFECTIVE

MAY 23 1995

PURSUANT TO 807 KAR 5:011,  
SECTION 9(1)

BY: Jordan C. Neel  
FOR THE PUBLIC SERVICE COMMISSION

(D)

Issued: June 13, 1995

Effective: May 23, 1995

*Deborah A. Nisch* President, Cincinnati, Ohio  
Vice President  
Integrated Corporate Planning for

ACCESS SERVICE TARIFF  
PSCK No. 2

CINCINNATI BELL TELEPHONE COMPANY

1st Revised Page 374  
Cancels Original Page 374

8. Billing and Collection Services (Cont'd)

8.1 Recording Service (Cont'd)

8.1.2 Undertaking of the Telephone Company (Cont'd)

(C) (Cont'd)

PUBLIC SERVICE COMMISSION  
OF KENTUCKY  
EFFECTIVE

MAY 23 1995

PURSUANT TO 807 KAR 5:011,  
SECTION 9(1)

BY: Jordan C. Neal  
FOR THE PUBLIC SERVICE COMMISSION

- (D) (D)
- (D) Recorded customer message detail will be provided (C)  
to a customer as set forth in (E) following. The (C)  
Telephone Company will determine the number of  
magnetic tapes or data files required to provide  
the recorded message detail to the customer.
- (E) At the request of a customer, magnetic tapes containing (C)  
the recorded customer message details will be provided  
to the customer as part of Recording Service. The magnetic (C)  
tapes will be provided without the return of previously  
supplied tapes. The Telephone Company will supply the  
magnetic tapes. Unless specified otherwise by the (T)  
customer, the magnetic tapes will be sent to the customer  
via overnight service paid by the customer. However, the (C)  
customer may pick up the magnetic tapes at a location  
designated by the

Issued: **June 13, 1995**

Effective: **May 23, 1995**

*Deborah A. Nisch*  
Vice President  
Integrated Corporate Planning for  
Cincinnati, Ohio

ACCESS SERVICE TARIFF  
PSCK No. 2

CINCINNATI BELL TELEPHONE COMPANY

1st Revised Page 375  
Cancels original Page 375

PUBLIC SERVICE COMMISSION  
OF KENTUCKY  
EFFECTIVE

8. Billing and Collection Services (Cont'd)

8.1 Recordinn Service (Cont'd)

8.1.2 Undertakinn of the Telephone Company (Cont'd)

MAY 23 1995

PURSUANT TO 807 KAR 5.011,  
SECTION 9(1)

(E) (Cont'd)

BY: J. A. He  
PUBLIC SERVICE COMMISSION

Telephone Company or request that the detail on the magnetic tapes or in a data file be data-transmitted to the customer. When the recorded customer message details are data-transmitted to a customer designated premises, the data transmission charges will be determined as set forth 8.1.7(D). Such a request must be made according to a mutually agreeable schedule. When the customer does not wish to receive the recorded customer message details and the Telephone Company receives notice from the customer at least two weeks prior to the date the details would be sent to the customer, the charge as set forth in 8.1.7(C) following does not apply. When the customer does not wish to receive the recorded customer message detail, the terms and conditions will be as set forth in the individual case basis agreement.

(C)

(C)

(C)

(C)

(F) Recorded customer message detail which is used at the request of the customer to provide Message Processing and Bill Rendering Service is not retained by the Telephone Company for longer than 45 days. The rated but unbilled message detail and the billed message detail is retained for reference (i.e. on paper or microfiche) in place of the recorded customer message detail. For recorded customer message detail not used by Message Processing Service at the customer's request, the Telephone Company will make every reasonable effort to recover recorded customer message detail previously made available to the customer and make it available again for the customer. The charges as set forth 8.1.7(C) following will apply for all such detail provided. When the recorded customer message details are data-transmitted to a customer premises, the data transmission charges are as set forth 8.1.7(D) following. Such a request must be made according to a mutually agreeable schedule from the date the details were initially made available to the customer.

(T)

(C)

(C)

Issued: June 13, 1995

Effective: May 23, 1995

Deborah A. Nisch President, Cincinnati, Ohio

Vice President  
Integrated Corporate Planning for

8. Billing and Collection Services (Cont'd)

8.1 Recording Service (Cont'd)

8.1.3 Liability of the Telephone Company

Notwithstanding 2.1.3 preceding, the Telephone Company liability for Recording Service is as follows:

(M)  
(M)

(A) Customer message data determined to be lost, damaged or destroyed as a result of the recording service shall be recovered if possible by the Telephone Company at no additional charge. In the event the data cannot be recovered, the Telephone Company shall estimate the messages and associated revenue based upon the method described below.

(N)

- (1) Partial Loss. For reporting purposes only, actual (or estimated) message and minute volumes should be reported to the customer by the Telephone Company where 1% or more of the daily messages/minutes for an entity are not able to be processed due to such things as tape read fails, invalid Entry Codes, wrong record length, and cancelled calls.
- (2) Complete Loss. Estimated message and minute volumes should be reported for each loss consisting of such things as an entire tape lost in transit, lost after receipt, degaussed before processing, and received blank or unreadable.

(N)

PUBLIC SERVICE COMMISSION  
OF KENTUCKY  
EFFECTIVE

MAY 23 1995

PURSUANT TO 807 KAR 5.011,  
SECTION 9 (1)

BY: Jordan C. Neel  
FOR THE PUBLIC SERVICE COMMISSION

Certain regulations on this page formerly appeared on page 376.

Issued: June 13, 1995

Effective: May 23, 1995

*Deborah A. Nisch*  
Vice President  
Integrated Corporate Planning for  
resident, Cincinnati, Ohio

8. Billing and Collection Services (Cont'd)

8.1 Recording Service (Cont'd)

8.1.3 Liability of the Telephone Company (cont'd)

(3) Estimated Volumes. From message and minute volume reports for the entity experiencing the loss, secure message/minute counts for the corresponding days of the four weeks preceding that in which the loss occurred. Compute an average of these volumes. Messages and associated minutes should be separated between Interstate and Intrastate. Apply the appropriate Average Revenue Per Message (ARPM) to the estimated message volume to arrive at the estimated lost revenue, except as set forth in (4) following.

(4) Exceptions to estimated volumes in (3) preceding are:

- (a) If the day of loss is not a holiday but one (or more) of the preceding corresponding days is a holiday, use additional preceding weeks in order to procure volumes for four non-holidays.
- (b) If the loss occurs on a weekday which is a holiday, except Christmas, use volumes from the four preceding Sundays.
- (c) If the loss occurs on Mother's Day or Christmas, use volumes from that day in the preceding year, if available.

(N)

(N)

PUBLIC SERVICE COMMISSION  
OF KENTUCKY  
EFFECTIVE

MAY 23 1995

PURSUANT TO 807 KAR 5.011,  
SECTION 9(1)

BY: Jordan C. Neal  
FOR THE PUBLIC SERVICE COMMISSION

Issued: June 13, 1995

Effective: May 23, 1995

Deborah A. Nisch President, Cincinnati, Ohio

Vice President  
Integrated-Corporate Planning for



ACCESS SERVICE TARIFF  
PSCK No. 2

CINCINNATI BELL TELEPHONE COMPANY

1st Revised Page 376  
Cancels Original Page 376

8. Billing and Collection Services (Cont'd)

8.1 Recording Service (Cont'd)

8.1.3 Liability of the Telephone Company (Cont'd)

- (T)
- (B) If customer message detail is not available because the Telephone Company lost or damaged tapes or incurred recording system outages, the Telephone Company will estimate the volume of lost customer messages and associated revenue as set forth in (A). This estimated customer message volume will be included along with the customer message detail provided to the customer and/or provided for Message Processing Service. In such events, the extent of the Telephone Company's liability for damages shall be limited to the granting of a corresponding credit adjustment to the customer amounts due to account for the unbillable revenue. (C)
- (C) When the Telephone Company is notified that, due to error or omission, incomplete data have been provided to a customer, the Telephone Company will make every reasonable effort to locate and/or recover the data and provide new magnetic tapes to the customer at no additional charge. Such request to recover the data must be made according to a mutually agreeable schedule from the date the details were initially made available to the customer. If the data are not recovered, the extent of the Telephone Company's liability for damages shall be limited as set forth above. (C)
- (D) In the absence of willful misconduct, no liability for damages to the customer or other person or entity other than as set forth above shall attach to the Telephone Company for its action or the conduct of its employees in providing Recording Service. (C)

MAY 23 1995

PURSUANT TO 807 KAR 5:011,  
SECTION 9 (1)

BY: Jordan C. Neel  
FOR THE PUBLIC SERVICE COMMISSION  
OF KENTUCKY  
EFFECTIVE

Certain regulations ~~previously~~ found on this page can now be found on page 375.1.

Issued: June 13, 1995

Effective: May 23, 1995

  
Deborah A. Nisch, President, Cincinnati, Ohio  
Vice President  
Integrated Corporate Planning for

ACCESS SERVICE TARIFF  
PSCK No. 2

CINCINNATI BELL TELEPHONE COMPANY

1st Revised Page 377  
Cancels Original Page 377

8. Billing and Collection Services (Cont'd)

8.1 Recording Service (Cont'd)

8.1.4 Obligations of the Customer

- (A) The customer shall order Recording Service under a Special Order for each state where the service is desired.

The customer shall order Recording Service at a mutually agreed upon date prior to the date when the customer message detail is to be recorded. (C)

- (B) The customer shall order provision of recorded customer message detail at a mutually agreed upon date prior to the date when it wishes to receive the recorded message detail. However, the customer may wish to receive magnetic tapes of the recorded customer message detail or have the recorded detail data-transmitted to a customer premises at some times and not at others. Therefore, change in the provision of recorded customer message detail to the customer will be accommodate provided the customer gives sufficient advance written notification to the Telephone Company. (C)

For recorded customer message detail the customer shall shall order the detail in accordance with the terms and conditions of the individual case basis established and filed in this tariff to cover the provision of recorded customer message detail. (C)

Appropriate Special Order Requests **must** be completed before the Telephone Company will consider the ordering of Recording Service to be official. (C)

- (C) The premises of the ordering customer shall provide such signals as may be required for the proper operation of the Telephone Company's automatic message accounting equipment used to perform the detail recordings.

PUBLIC SERVICE COMMISSION,  
OF KENTUCKY  
EFFECTIVE

MAY 23 1995

PURSUANT TO 807 KAR 5.011,  
SECTION 9 (1)

BY: Jordan C. Neal  
FOR THE DIRECTOR

Issued: June 13, 1995

Effective: May 23, 1995

Deborah P. Nisch President, Cincinnati, Ohio  
Vice President  
Integrated Corporate Planning for

ACCESS SERVICE TARIFF  
PSCK No. 2

CINCINNATI BELL TELEPHONE COMPANY

1st Revised Page 378  
Cancels Original Page 378

8. Billing and Collection Services (Cont'd)

8.1 Recording Service (Cont'd)

8.1.5 Payment Arrangements and Audit Provision

(A) Audit Provision

Upon reasonable written notice by the customer to the Telephone Company, the customer shall have the right through its authorized representative to examine and audit, during normal business hours and at reasonable intervals as determined by the Telephone Company, all such records and accounts as may under recognized accounting practices contain information bearing upon the recording of messages for which amounts may be payable to the customer. Adjustment shall be made by the proper party to compensate for any errors or omissions disclosed by such examination or audit. Neither such right to examine and audit nor the right to receive such adjustment shall be affected by any statement to the contrary, appearing on checks or otherwise, unless such statement expressly waiving such right appears in a letter signed by the authorized representative of the party having such right and delivered to the other party.

All information received or reviewed by the customer or its authorized representative is to be considered confidential and is not to be distributed, provided or disclosed in any form to anyone not involved in the audit, nor is such information to be used for any other purpose.

(B) Minimum Period and Minimum Monthly Charge

The minimum period for which Recording Service is provided and for which charges apply is one month for each state in which the service is ordered.

(C)

PUBLIC SERVICE COMMISSION  
OF KENTUCKY  
EFFECTIVE

MAY 23 1995

PURSUANT TO 807 KAR 5.011,  
SECTION 9(1)

BY Jordan C. Neal  
FOR THE P.S.C.

Issued: June 13, 1995

Effective: May 23, 1995

Deborah A. Nisch President, Cincinnati, Ohio  
Vice President  
Integrated Corporate Planning for

ACCESS SERVICE TARIFF  
PSCK No. 2

CINCINNATI BELL TELEPHONE COMPANY

1st Revised Page 379  
Cancels Original Page 379  
PUBLIC SERVICE COMMISSION  
OF KENTUCKY  
EFFECTIVE

8. Billing and Collection Services (Cont'd)

8.1 Recording Service (Cont'd)

8.1.5 Payment Arrangements and Audit Provision (Cont'd)

(B) Minimum Period and Minimum Monthly Charge (Cont'd)

THE minimum monthly charges are the charges for customer messages recorded, customer messages assembled and edited (except when Message Processing Service is ordered for the same monthly period) and when ordered by the customer, provision of customer message detail on magnetic tapes or data files. If the service is cancelled or discontinued prior to entering the customer message detail on magnetic tapes or data files, the minimum monthly charge will be the charge for all customer messages recorded, assembled and edited for a 30 day period. The Telephone Company will use the most recent 30 day period for which data is available to determine the minimum charge.

MAY 23 1995  
PURSUANT TO 807 KAR 5011,  
SECTION 9(1)  
BY: Jordan C. Neal  
FOR THE PUBLIC SERVICE COMMISSION

(C) Cancellation of a Special Order

A customer may cancel a Special Order for Recording Service on any date prior to the service date. The cancellation date is the date the Telephone Company receives written or verbal notice from the customer that the Special Order is to be cancelled. The verbal notice must be followed by written confirmation within 10 days. The service date for Recording Service is the date the customer requests the recordings to start.

When a customer cancels a Special Order for Recording Service after the order date but prior to the start of service, the minimum monthly charges will apply.

(D) Changes To Special Orders

When a customer requests material changes to a pending Special Order for Recording Service, the pending Special Order will be cancelled and the requested changes will be undertaken if they can be accommodated by the Telephone Company under a new Special Order. Material changes to a pending Special Order for Recording Service includes changes in the location and/or number

Issued: June 13, 1995

Effective: May 23, 1995

  
Deborah A. Nisich, President, Cincinnati, Ohio  
Vice President  
Integrated Corporate Planning for

ACCESS SERVICE TARIFF  
PSCK No. 2

CINCINNATI BELL TELEPHONE COMPANY

1st Revised Page 380  
Cancels Original Page 380

8. Billing and Collection Services (Cont'd)

8.1 Recording Service (Cont'd)

8.1.5 Payment Arrangements and Audit Provision (Cont'd)

(D) Changes to Special Orders (Cont'd)

of Telephone Company recording locations, provision of data (C) transmission to a customer location of customer recorded message detail, and changes in schedules, dates or intervals for receipt of customer recorded message detail. Non-material changes to a pending Special Order include changes in customer name, customer address and customer requests to receive Recording Service output at the Telephone Company location instead of overnight service. All (C) cancellation charges as set forth in (C) preceding will apply for the cancelled Special Order.

8.1.6 Rate Regulations

- (A) For each customer message recorded, the recording and the assembling and editing charges apply except when the customer orders Message Processing Service. When Message Processing Service as set forth in 8.2.1 following is ordered for the same state and month that Recording Service is ordered, the assembling and editing charge does not apply per customer message.

The charges for recording and for assembly and editing apply per message recorded whether or not the customer's schedule of rates specifies billing on a per message basis or any other basis.

- (B) The per Special Order charge applies for each Special Order accepted by the Telephone Company for Recording Service.

PUBLIC SERVICE COMMISSION  
OF KENTUCKY  
EFFECTIVE

MAY 23 1995

PURSUANT TO 807 KAR 5.011,  
SECTION 9(1)

BY: Jordan C. Neal  
FOR THE PUBLIC SERVICE COMMISSION

Issued: June 13, 1995

Effective: ~~May~~ 23, 1995

*Deborah A. Nisch* President, Cincinnati, Ohio  
Vice President  
Integrated Corporate Planning for

ACCESS SERVICE TARIFF  
PSCK No. 2

CINCINNATI BELL TELEPHONE COMPANY

1st Revised Page 381  
Cancels Original Page 381

8. Billing and Collection Services (Cont'd)

8.1 Recordinn Service (Cont'd)

8.1.6 Rate Regulations (Cont'd)

- (C) When message detail is entered on a data file or magnetic tape for provision of message detail to a customer, the per tape charge applies for each data file or magnetic tape prepared, and the per record charge applies for each record processed. A record is a logical grouping of information as described in the programs that process the information and load the magnetic tapes or data file. The Telephone Company will determine the charges based on the number of data files or magnetic tapes prepared and on its count of the records processed. The number of records processed will be determined using the number of records input to or the number of records output from the programs that process the information and load the magnetic tapes or data files, whichever number of records is higher. (C)

PUBLIC SERVICE COMMISSION  
OF KENTUCKY  
EFFECTIVE

MAY 23 1995

PURSUANT TO 807 KAR 5.011,  
SECTION 9(1)

BY: Jordan C. Neel  
FOR THE PUBLIC SERVICE COMMISSION

Issued: June 13, 1995

Effective: May 23, 1995

 Deborah A. Nisch, President, Cincinnati, Ohio  
Vice President  
Integrated Corporate Planning for

ACCESS SERVICE TARIFF  
PSCK No. 2

CINCINNATI BELL TELEPHONE COMPANY

1st Revised Page 382  
Cancels Original Page 382

8. Billing and Collection Services (Cont'd)

8.1 Recording Service (Cont'd)

8.1.7 Rate and Charges

The rates and charges are:

|   | <u>Rates</u>                                | (T)                               |
|---|---|-----------------------------------|
| (A) Recording,<br>- per customer message<br>- per Special Order             | \$ 0.0120(I)<br>10.51                       | (T)                               |
| (B) Assembling and editing,<br>- per customer message*                      | 0.0017                                      |                                   |
| (C) Provision of customer<br>Message detail,<br><br>- per tape or data file | ICB rates and<br>charges apply<br><br>55.00 | (T)<br>(T)                        |
| (D) Data transmission,<br>- per record transmitted                          | .0070(R)                                    | (D)<br> <br>(D)<br><br>(C)<br>(C) |

PUBLIC SERVICE COMMISSION  
OF KENTUCKY  
EFFECTIVE

MAY 23 1995

PURSUANT TO 807 KAR 5:011,  
SECTION 9(1)

BY: Jordan C. Neal  
FOR THE PUBLIC SERVICE COMMISSION

\*Applicable when Recording Service is ordered without Message Processing Service. Not applicable when Message Processing Services, as set forth in 8.2.1 following, is provided to the customer except as set forth in 8.2.1(B)(1)(c) and 8.2.1(B)(2)(d) following.

Issued: June 13, 1995

Effective: May 23, 1995

*Deborah A. Niseler*

President, Cincinnati, Ohio

Vice President  
Integrated Corporate Planning for

ACCESS SERVICE TARIFF  
PSCK No. 2

CINCINNATI BELL TELEPHONE COMPANY

1st Revised Page 383  
Cancels Original Page 383

8. Billinn and Collection Services (Cont'd)

8.2 Billing Service

At the request of a customer, the Telephone Company with reasonable notice and reasonable effort will provide Billing Service.

The Telephone Company will provide Billing Service in its operating territory. The minimum territory for which the Telephone Company will provide Billing Service is its state operating territory when the Telephone Company supplies the input records at the customer's request. When the customer supplies the input records, the Telephone Company will process the input records supplied by the customer as set forth in 8.2.1 following. (C)

The Telephone Company will provide Message Billing Service as set forth in 8.2.1. (C)

The Telephone Company will provide Bill Rendering Service only on the condition that (1) it purchases the accounts receivable, if any, from the customer as set forth in 8.2.3 following or (2) the Telephone Company agrees to act as billing agent for the customer. (C)

The Telephone Company will not render bills under this tariff for the provision and/or delivery of telegrams, flowers, gifts, wine or other like services that a customer offers.

8.2.1 Message Billing Service

Message Billing service consists of Message Processing Service and Bill Rendering Service. A customer may order Message Processing Service or Bill Rendering Service or both services. (T)

(A) General Description

(1) Message Processinn Service

Message Processing Service is the transforming of the recorded customer call details into rated messages in preparation for billing. Message Processing Service includes initial data entry and rating of messages. PUBLIC SERVICE COMMISSION OF KENTUCKY EFFECTIVE

MAY 23 1995

PURSUANT TO 807 KAR 5.011,  
SECTION 9 (1)  
BY: Jordan C. Meel  
FOR THE PUBLIC SERVICE COMMISSION

Issued: June 13, 1995

Effective: May 23, 1995

Deborah A. Nisch, resident, Cincinnati, Ohio  
Vice President  
Integrated Corporate Planning for



ACCESS SERVICE TARIFF  
PSCK No. 2

CINCINNATI BELL TELEPHONE COMPANY

1st Revised Page 384  
Cancels Original Page 384

PUBLIC SERVICE COMMISSION  
OF KENTUCKY  
EFFECTIVE

8. Billinn and Collection Services (Cont'd)

8.2 Billinn Service (Cont'd)

8.2.1 Message Billinn Service (Cont'd)

MAY 23 1995

PURSUANT TO 807 KAR 5:011,  
SECTION 9(1)

(A) General Description (Cont'd)

(1) Message Processing Service (Cont'd)

BY: Jordan C. Neal  
FOR THE PUBLIC SERVICE COMMISSION

Initial data entry is the assembly of recorded customer call details into customer messages. This function includes editing and verification of recorded details to assure that the data required for rating are present.

Rating of customer messages is the computing of applicable charges for each customer message based on the customer provided schedule of rates. Rating also includes the preparation of customer message detail for input to Bill Rendering Service, the customer, or other entities. (T)

Further, rating is always performed and editing may be performed coincident with the implementation of a change in the customer's schedule of rates.

(2) Bill Rendering Service (T)

Bill Rendering Service is the preparation of bills for message-billed service and bulk-billed service, mailing of statements of the amounts due for service received from the customer and the collection of deposits and monies due from the end users. Bill Rendering Service includes message-billed (when necessary) and bulk-billed account establishment, posting of rated messages and rate elements, rendering of bills, collection of deposits, receiving payments, maintenance of accounts, treatment of accounts, message investigation and inquiry (when ordered by the customer.) (T)

Issued: June 13, 1995

Effective: May 23, 1995

*Deborah A. Risch*

President, Cincinnati, Ohio

Vice President  
Integrated Corporate Planning for

ACCESS SERVICE TARIFF  
PSC No. 2

CINCINNATI BELL TELEPHONE COMPANY

1st Revised Page 385  
Cancels Original Page 385  
PUBLIC SERVICE COMMISSION  
OF KENTUCKY  
EFFECTIVE

8. Billinn and Collection Services (Cont'd)

8.2 Billinn Service (Cont'd)

8.2.1 Messane Billinn Service (Cont'd)

(A) General Description (Cont'd)

(2) Bill Rendering Service (Cont'd)

MAY 23 1995

PURSUANT TO 807 KAR 5:011,  
SECTION 9 (1)

BY: Jordan C. Neel (T)  
FOR THE PUBLIC SERVICE COMMISSION

Bulked-billed service is a billing service for an end user account with an access line where individual customer messages are not posted to the account and are not listed on the bill rendered to the end user. (C)

Message-billed service is a billing service for an end user account with an end user common line where individual customer messages are posted to the account and are listed on the bill rendered to the end user.

(D)  
|  
(D)

Account establishment is the preparation of a customer's end user record so that a bill can be sent to that end user.

Posting of rated messages is the processing for billing of rated messages. Posting also is the examination and identification of all the rateable elements specified by the customer to be billed to an end user. Application of appropriate customer rates and charges to all such rate elements is also included when requested by the customer. The rating may be performed by the Telephone Company, another entity or the customer. Editing and rating of rate elements is performed when customer services are established or changed. Rating is always performed and editing may be performed coincident with the implementation of a change in the customer's schedule of rates.

Issued: June 13, 1995

Effective: May 23, 1995

*Deborah A. Nisch* President, Cincinnati, Ohio  
Vice President  
Integrated Corporate Planning for

ACCESS SERVICE TARIFF  
PSCK No. 2

CINCINNATI BELL TELEPHONE COMPANY

1st Revised Page 386  
Cancels **Original** Page 386

PUBLIC SERVICE COMMISSION  
OF KENTUCKY  
EFFECTIVE

8. ~~Billing and Collection Services~~ (Cont'd)

8.2 Billing Service (Cont'd)

8.2.1 Message Billing Service (Cont'd)

(A) ~~General Description~~ (Cont'd)

(2) Bill Rendering Service (Cont'd)

MAY 23 1995

PURSUANT TO 807 KAR 5.011,  
SECTION 9(1)

BY: Jordan C. Neel (T)  
FOR THE PUBLIC SERVICE COMMISSION

Rendering of bills is the preparation and mailing of statements of the deposits and amounts due from the end user for customer message-billed and bulk-billed services. These statements may, at Telephone Company choice, be included as part of the regular monthly bill for local Telephone Exchange Service mailed to the end user.

Receiving payment and maintenance of accounts is the collecting of monies from end users for services furnished by the customer and maintenance of records of all transactions.

Treatment of accounts is the forwarding of notices of delinquent or unpaid end user accounts and posting of credits and adjustments.

Message investigation is that activity undertaken by the Telephone Company to secure, or attempt to secure, proper billing information for customer messages.

Issued: June 13, 1995

Effective: ~~May~~ 23, 1995

  
President, Cincinnati, Ohio  
Vice President  
Integrated Corporate Planning for

ACCESS SERVICE TARIFF  
PSCK No. 2

CINCINNATI BELL TELEPHONE COMPANY

1st Revised Page 387  
Cancels Original Page 387  
PUBLIC SERVICE COMMISSION,  
OF KENTUCKY  
EFFECTIVE

8. Billinn and Collection Services (Cont'd)

8.2 Billing Service (Cont'd)

8.2.1 Message Billing Service (Cont'd)

(A) General Description (Cont'd)

(2) Billing Rendering Service (Cont'd) FOR THE PUBLIC SERVICE COMMISSION (T)

MAY 23 1995

PURSUANT TO 807 KAR 5.011,  
SECTION 9 (1)

BY: Jordan C. Neal

Inquiry is the answering of end user questions about charges billed for customer services and application of credits and adjustments to end user accounts and review of customer messages removed from an end user's bill.

(B) Undertaking of the Telephone Company

(1) Message Processing Service

(a) When Message Processing is ordered by a customer, the Telephone Company will process all of the customer messages it possesses in a state as set forth in (b) through (1) following at rates and charges set forth in (G) following.

(b) The Telephone Company will provide Message Processing Service only for customer messages originating or recorded within the operating territory of the Telephone Company. The customer messages which the Telephone Company will process may be customer messages from Recording Service as set forth in 8.1 preceding or, at the direction of the customer, other customer messages which are chargeable in accordance with the rate schedule furnished by the customer.

Any sent-paid coin messages provided as input by the customer will be processed unless the customer specifies in writing that such messages are not to be processed. When such messages are processed message processing charges will apply. When such messages are not processed they may not be included in any message detail provided to the customer.

Issued: June 13, 1995

Effective: May 23, 1995

  
Deborah D. Nisch, President, Cincinnati, Ohio  
Vice President  
Integrated Corporate Planning for

ACCESS SERVICE TARIFF  
PSCK No. 2

CINCINNATI BELL TELEPHONE COMPANY

1st Revised Page 388  
Cancels *Original* Page 388

PUBLIC SERVICE COMMISSION  
OF KENTUCKY  
EFFECTIVE

8. Billing and Collection Services (Cont'd)

8.2 Billinn Service (Cont'd)

8.2.1 Messane Billing Service (Cont'd)

(B) Undertaking of the Telephone Company (Cont'd)

(1) Messane Processing Service (Cont'd)

- (c) A record of customer call details is required to provide Message Processing Service. Where a customer subscribes to Recording Service as set forth in 8.1 preceding, those recorded details may be used as the input. Where the customer provides the call details, the records must be in the standard format established by the Telephone Company and delivered to the location specified by the Telephone Company. The charges as set forth in (G)(4) following will apply if the customer (C) data-transmits its call details to the Telephone Company. If the customer provided records must be converted by the Telephone Company to the standard format, and the Telephone Company agrees to make the conversion, the program development charges as set forth in (G)(3) following apply for the hours required to design, develop, test and maintain the necessary programs. The assembling and editing charge, as set forth in 8.2.1(G) following applies in addition (C) to all other charges for all such details converted by the Telephone Company. The Telephone Company will provide to the customer the precise details of the required standard format. If, in the course of Telephone Company business, it is necessary to change the standard format, the Telephone Company will provide notification to the involved customers *six* months prior to the change. If the customer requests customer provided call details to be reprocessed by the Telephone Company because of a customer error, the Telephone Company will reprocess the customer provided call details and the appropriate charges as set forth in (G) following will apply.

MAY 23 1995

PURSUANT TO 807 KAR 5011,  
SECTION 9(1)

BY: Jordan C. Neal  
FOR THE PUBLIC SERVICE COMMISSION

Issued: June 13, 1995

Effective: May 23, 1995

  
President, Cincinnati, Ohio  
Vice President  
Integrated Corporate Planning for

8. Billing and Collection Services (Cont'd)

8.2 Billing Service (Cont'd)

8.2.1 Message Billing Service (Cont'd)

(B) Undertaking of the Telephone Company (Cont'd)

(1) Message Processing Service (Cont'd)

- (d) The Telephone Company will develop the customer's schedule of rates into a rating program. Program development charges, as set forth in (G)(3) following, apply for the hours required to design, develop, test and maintain the necessary programs.
- (e) Upon acceptance by the Telephone Company of a Special Order for Message Processing Service from a customer, the Telephone Company will determine the period of time to implement such service on an individual order basis.
- (f) Changes in the rate levels of customer charges to be billed will normally be implemented within 30 days after receipt of a Special Order from the customer requesting such changes. Such changes will require modifications of the rating program. Program development charges, as set forth in (G)(3) following, apply for the hours required to design, develop, test and maintain the necessary program changes. If any customer message detail must be reprocessed in order to apply the rate changes, the appropriate message processing charges as set forth in (G)(1) and (G)(2) following apply for all customer messages reprocessed.
- (g) Changes in the rate structure for customer services to be billed also require a change in the rating program. When the Telephone Company determines that it can accommodate the changes, the conditions

PUBLIC SERVICE COMMISSION  
OF KENTUCKY  
EFFECTIVE

MAR 3 1992

PURSUANT TO 807 KAR 5:011,  
SECTION 9 (1)

BY:   
PUBLIC SERVICE COMMISSION

Issued: February 7, 1992

Effective: March 3, 1992

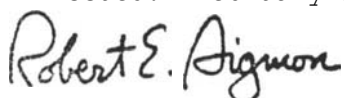
 for President, Cincinnati, Ohio

Vice President - Regulatory Affairs

ACCESS SERVICE TARIFF  
PSCK No. 2

CINCINNATI BELL TELEPHONE COMPANY

1st Revised Page 390  
Cancels Original Page 390

8. Billinn and Collection Services (Cont'd)

PUBLIC SERVICE COMMISSION  
OF KENTUCKY  
EFFECTIVE

8.2 Billinn Service (Cont'd)

8.2.1 Message Billing Service (Cont'd)

MAY 23 1995

(B) Undertaking of the Telephone Company (Cont'd)

PURSUANT TO 807 KAR 5011,  
SECTION 9(1)  
BY: Jordan C. Neal  
FOR THE PUBLIC SERVICE COMMISSION

(1) Message Processing Service (Cont'd)

(g) (Cont'd)

of time required to make such changes will be determined on an individual order basis. Program development charges, as set forth in (G)(3) following, apply for the hours required to design, develop, test and maintain the necessary program changes. If any customer message detail must be reprocessed in order to apply the rate structure changes, the appropriate message processing charges as set forth in (G)(1) and (G)(2) following apply for all customer messages reprocessed.

- (h) Where the Telephone Company has rated customer messages which are to be billed to an end user by another Exchange Telephone Company, the Telephone Company will enter the messages on a magnetic tape or data file which can be used for data transmission of the details. When the customer has so arranged with an involved Exchange Telephone Company, the Telephone Company will transmit the rated message details to such other Exchange Telephone Company for billing to end users in its operating territories. When the customer does not have billing arrangements with an Exchange Telephone Company, rated messages for billing to the end users of such an Exchange Telephone Company will be delivered to the customer. The charges as set forth in (G)(4) following apply to rated messages that are data-transmitted to the customer or other Exchange Telephone Companies. (C)

Issued: **June 13, 1995**

Effective: **May 23, 1995**

 President, Cincinnati, Ohio  
Vice President  
Integrated Corporate Planning for

ACCESS SERVICE TARIFF  
PSC No. 2

CINCINNATI BELL TELEPHONE COMPANY

1st Revised Page 391  
Cancels Original Page 391

8. Billinn and Collection Services (Cont'd)

PUBLIC SERVICE COMMISSION  
OF KENTUCKY  
EFFECTIVE

8.2 Billinn Service (Cont'd)

8.2.1 Messane Billinn Service (Cont'd)

(B) Undertakinn of the Telephone Company (Cont'd)

MAY 23 1995

PURSUANT TO 807 KAR 5.011,  
SECTION 9(1)

(1) Messane Processinn Service (Cont'd)

BY: Jordan C. Neal  
FOR THE PUBLIC SERVICE COMMISSION

(h) (Cont'd)

When the customer message details are data-transmitted to the location designated by the customer, the data transmission charges will be determined as set forth in (G)(4) following. Program development charges as set forth in (G)(3) following apply for the hours required to design, develop, test and maintain the necessary programs. (C)

(i) Where the rates for customer services have been implemented under an accounting order pending final approval from a regulatory agency, the Telephone Company will, upon written request from the customer, keep such records as may be required to make any adjustments to the end users as may be ordered by the regulatory agency. The charges for such a service will be determined on an individual case basis.

(j) The Telephone Company will, upon request, provide the customer the rated message detail.

The rated message detail will be provided on a request by request basis in a format similar to that used by the Telephone Company as input to Bill Rendering Service. All rated customer message detail available to the Telephone Company will be provided to the customer. The rated customer message detail will not be sorted to furnish detail by specific end users, groups of end users, by office or by location. (T)

Issued: June 13, 1995

Effective: May 23, 1995

President, Cincinnati, Ohio

*Deborah A. Nisch*

Vice President  
Integrated Corporate Planning for



ACCESS SERVICE TARIFF  
PSCK No. 2

CINCINNATI BELL TELEPHONE COMPANY

1st Revised Page 392  
Cancels Original Page 392

8. Billinn and Collection Services (Cont'd)

PUBLIC SERVICE COMMISSION  
OF KENTUCKY  
EFFECTIVE

8.2 Billinn Service (Cont'd)

8.2.1 Message Billing Service (Cont'd).

MAY 23 1995

(B) Undertaking of the Telephone Company (Cont'd)

PURSUANT TO 807 KAR 5.011,  
SECTION 9(1)

(1) Message Processing Service (Cont'd)

BY: Jordan C. Neal  
FOR THE PUBLIC SERVICE COMMISSION

(j) (Cont'd)

The Telephone Company will provide the customer detail on a magnetic tape. The magnetic tapes will be provided without the return of previously supplied tapes. The Telephone Company will supply the magnetic tapes. Program development charges, as set forth in (G)(3) following, apply for the hours required to design, develop, test and maintain the necessary programs. When a magnetic tape is provided, the charges as set forth in (G)(5) following also apply.

Unless specified otherwise by the customer, the magnetic tapes will be sent to the customer via overnight service paid by the customer. However, the customer may pick up the magnetic tapes at a location designated by the Telephone Company or request the information on the magnetic tapes be data-transmitted to the customer. When the information is data-transmitted to a location designated by the customer, the data transmission charges will be determined as set forth in (G)(4) following.

(G)  
(G)

(G)  
(G)

- (k) If the customer makes a request within 30 days of the date the customer details were initially made available to the customer, the Telephone Company will make a reasonable effort to recover the customer detail and make it available again to the customer. The charges as set forth in (G)(5) will apply for all such customer detail provided. When the customer details are data-transmitted to a location designated by the customer, the data transmission charges will be determined as set forth in (G)(4) following.

(G)  
(G)

Issued: June 13, 1995

Effective: May 23, 1995

*Deborah A. Nisch*

President, Cincinnati, Ohio

Vice President  
Integrated Corporate Planning for

ACCESS SERVICE TARIFF  
PSCK No. 2

CINCINNATI BELL TELEPHONE COMPANY

1st Revised Page 393  
Cancels Original Page 393

PUBLIC SERVICE COMMISSION  
OF KENTUCKY  
EFFECTIVE

8. Billing and Collection Services (Cont'd)

8.2 Billing Service (Cont'd)

8.2.1 Message Billing Service (Cont'd)

MAY 23 1995

(B) Undertaking of the Telephone Company (Cont'd)

PURSUANT TO 807 KAR 5.011,  
SECTION 3(1)

(1) Message Processing Service (Cont'd)

BY: Jordan C. Neal  
FOR THE PUBLIC SERVICE COMMISSION

- (1) Customer messages which the Telephone Company processes that cannot be rated in accordance with the customer rate schedule will be reviewed by Telephone Company message investigation groups. Upon completion of the review, rated customer messages will be delivered to the customer when the customer orders such service or to Bill Rendering Service when the customer orders such service. Unrated messages will be handled in accordance with instructions that have been mutually determined by the Telephone Company and the customer. At the request of the customer, the unrated customer messages will be reviewed for unauthorized use of the customer service by Telephone Company message investigation groups for a period of up to 90 days after the customer message was processed. The appropriate charges, as set forth in (G)(5) following or (G)(7) and (G)(8) following, will apply.

(T)

Issued: June 13, 1995

Effective: May 23, 1995

President, Cincinnati, Ohio

*Deborah A. Nisch*

Vice President  
Integrated Corporate Planning for

ACCESS SERVICE TARIFF  
PSCK No. 2

CINCINNATI BELT, TELEPHONE COMPANY

1st Revised Page 394  
Cancels Original Page 394

8. Billing and Collection Services (Cont'd)

8.2 Billing Service (Cont'd)

8.2.1 Message Billing Service (Cont'd)

(B) Undertaking of the Telephone Company (Cont'd)

(2) Bill Rendering Service

(T)

- (a) When Bill Rendering Service is ordered by a customer, the Telephone Company will establish and maintain end user accounts and prepare and render bills for all customer messages, bulk-billed messages and related rate elements it possesses for a state as set forth in (b) through (n) following at rates and charges as set forth in (G) following. The Telephone Company will not establish an end user account with any customer balance due.

(T)

In addition, the Telephone Company will, in accordance with Telephone Company deposit regulations, determine and collect a deposit from the end user for the customer service. The Telephone Company will, when necessary in accordance with the Telephone Company deposit regulations, determine and collect the service deposit when an end user account is established or for established accounts when the first customer message is posted to the end user account.

PUBLIC SERVICE COMMISSION  
OF KENTUCKY  
EFFECTIVE

MAY 23 1995

PURSUANT TO 807 KAR 5.011,  
SECTION 9(1)

BY: Jordan C. Neal  
FOR THE PUBLIC SERVICE

The Telephone Company will, when necessary in accordance with the Telephone Company deposit regulations, maintain a service deposit balance for each end user account. Service deposits will not be maintained by individual customer accounts but will be maintained for the end user account in general. The Telephone Company will provide the customer a copy of its service deposit regulations upon receipt from the customer.

Issued: June 13, 1995

Effective: **May 23, 1995**

  
President, Cincinnati, Ohio  
Vice President  
Integrated Corporate Planning for

ACCESS SERVICE TARIFF  
PSCK No. 2

CINCINNATI BELL TELEPHONE COMPANY

1st Revised Page 395  
Cancels Original Page 395

8. Billinn and Collection Services (Cont'd)

8.2 Billing Service (Cont'd)

8.2.1 Message Billinn Service (Cont'd)

(B) Undertaking of the Telephone Company (Cont'd)

(2) Bill Rendering Service (Cont'd)

(T)

- (b) The Telephone Company will provide Bill Rendering Service for message-billed service, bulk-billed service and related rate elements which are posted to end user accounts located within the operating territory of the Telephone Company only. The Telephone Company will separate the rated customer messages into a message-billed group and a bulk-billed group for application of rates as set forth in (G) following.

(T)

(c)

(D)

PUBLIC SERVICE COMMISSION  
OF KENTUCKY  
EFFECTIVE

(D)

MAY 23 1995

PURSUANT TO 807 KAR 5:011,  
SECTION 9 (1)

BY: Jordan C. Neal  
FOR THE PUBLIC SERVICE COMMISSION

Issued: June 13, 1995

Effective: May 23, 1995

*Deborah A. Nisch*

President, Cincinnati, Ohio

Vice President  
Integrated Corporate Planning for

ACCESS SERVICE TARIFF  
PSCK No. 2

CINCINNATI BELL TELEPHONE COMPANY

1st Revised Page 396  
Cancels **Original** Page 396

8. Billinn and Collection Services (Cont'd)

8.2 Billinn Service (Cont'd)

8.2.1 Messane Billing Service (Cont'd)

(B) Undertaking of the Telephone Company (Cont'd)

(2) Bill Rendering Service (Cont'd)

(c) (Cont'd)

(T)

(D)

(D)

PUBLIC SERVICE COMMISSION  
OF KENTUCKY  
EFFECTIVE

MAY 23 1995

PURSUANT TO 807 KAR 5.011,  
SECTION 9 (1)

BY: Jordan C. Neal  
FOR THE PUBLIC SERVICE COMMISSION

Issued: **June** 13, 1995

Effective: **May** 23, 1995

*Deborah A. Nisch*  
President, Cincinnati, Ohio  
Vice President  
**Integrated** Corporate Planning for

ACCESS SERVICE TARIFF  
PSCK No. 2

CINCINNATI BELL TELEPHONE COMPANY

1st Revised Page 397  
Cancels *Original* Page 397

8. Billinn and Collection Services (Cont'd)

8.2 Billinn Service (Cont'd)

8.2.1 Messane Billinn Service (Cont'd)

(B) Undertakinn of the Telephone Company (Cont'd)

(2) Bill Rendering Service (Cont'd)

- (d) Rated customer messages are required to provide Bill Rendering Service. If the customer subscribes to Message Processing Service as set forth in (1) preceding, the rated customer messages may be used as the input. If the customer provides the rated customer messages, those customer messages must be in the standard format established by the Telephone Company and delivered to the location specified by the Telephone Company. The charges as set forth in (G)(4) following apply if the customer data-transmits its rated message data to the Telephone Company.

PUBLIC SERVICE COMMISSION  
OF KENTUCKY  
EFFECTIVE

MAY 23 1995

PURSUANT TO 807 KAR 5011,  
SECTION 9(1)

BY: Jordan C. Neal  
FOR THE PUBLIC SERVICE COMMISSION

Such customer provided rated message data must identify the end user account to be billed. If the customer provided rated messages must be converted by the Telephone Company to the standard format and the Telephone Company agrees to make the conversion, program development charges as set forth in (G)(3) following apply for the hours required to design, develop, test and maintain the necessary programs. The assembling and editing charge, as set forth in 8.1.7(B) preceding, applies in addition to all other charges for all such rated customer messages converted by the Telephone Company. The Telephone Company will provide to the customer the precise details of the required format. If, in the course of Telephone Company business, it is necessary to change the format, the Telephone Company will notify the involved customers *six* months

Issued: June 13, 1995

Effective: **May 23, 1995**

Deborah A. Nisch President, Cincinnati, Ohio  
Vice President  
Integrated Corporate Planning for

ACCESS SERVICE TARIFF  
PSCK No. 2

CINCINNATI BELL TELEPHONE COMPANY

1st Revised Page 398  
Cancels Original Page 398

8. Billinn and Collection Services (Cont'd)

8.2 Billinn Service (Cont'd)

8.2.1 Message Billinn Service (Cont'd)

(B) Undertakinn of the Telephone Company (Cont'd)

(2) Bill Rendering Service (Cont'd)

(T)

(d) (Cont'd)

prior to the change. If the customer requests the customer provided rated messages to be reprocessed by the Telephone Company because of a customer error, the Telephone Company will reprocess the customer provided rated messages and the appropriate charges as set forth in (G) following will apply.

PUBLIC SERVICE COMMISSION  
OF KENTUCKY  
EFFECTIVE

MAY 23 1995

PURSUANT TO 807 KAR 5:011,  
SECTION 9(1)

BY: Jordan C. Neel  
FOR THE PUBLIC SERVICE COMMISSION

(e) For end user accounts in its operating territory where the customer has ordered Bill Rendering Service, the Telephone Company will bill all rated customer messages provided by the customer. The bill format will be determined by the Telephone Company.

(T)

(f) Upon acceptance by the Telephone Company of a Special Order for Bill Rendering Service from a customer, the Telephone Company will determine the conditions and the period of time to implement such service on an individual order basis, Program development charges, as set forth in (G)(3) following, apply for the hours required to design, develop, test and maintain the necessary programs including any programs to rate, change the rates of or change the rate structure of any rate elements associated with the customer services.

(T)

(g) The Telephone Company will provide Bill Rendering Service only on the condition that (1) it purchases the accounts receivable from the customer as set forth in 8.2.3 following or (2) the Telephone Company agrees to act as billing agent for the customer.

(T)

Issued: June 13, 1995

Effective: May 23, 1995

Deborah A. Nisch President, Cincinnati, Ohio  
Vice President  
Integrated Corporate Planning for

ACCESS SERVICE TARIFF  
PSCK No. 2

CINCINNATI BELL TELEPHONE COMPANY

1st Revised Page 399  
Cancels Original Page 399

8. Billinn and Collection Services (Cont'd)

8.2 Billinn Service (Cont'd)

8.2.1 Message Billinn Service (Cont'd)

(B) Undertaking of the Telephone Company (Cont'd)

(2) Bill Rendering Service (Cont'd)

(T)

- (h) The Telephone Company will not provide any information related to Bill Rendering Service accounts under this section of the tariff. Bill Rendering Services information may be obtained as set forth in 8.4 following.

(T)

(T)

PUBLIC SERVICE COMMISSION  
OF KENTUCKY  
EFFECTIVE

MAY 23 1995

PURSUANT TO 807 KAR 5011,  
SECTION 9(1)

BY: Jordan C. Neal  
FOR THE PUBLIC SERVICE COMMISSION

Issued: June 13, 1995

Effective: May 23, 1995

 President, Cincinnati, Ohio  
Vice President  
Integrated Corporate Planning for



ACCESS SERVICE TARIFF  
PSCK No. 2

CINCINNATI BELL TELEPHONE COMPANY

1st Revised Page 400  
Cancels Original Page 400

8. Billing and Collection Services (Cont'd)

8.2 Billing Service (Cont'd)

8.2.1 Message Billing Service (Cont'd)

(B) Undertaking of the Telephone Company (Cont'd)

(2) Bill Rendering Service (Cont'd)

(1) The Telephone Company will, at the option of the customer, provide message-billed Bill Rendering Service with or without inquiry and bulk-billed Bill Rendering Service with or without inquiry. When the Telephone Company provides inquiry, the Telephone Company will be responsible for contacts and arrangements with the customer's end users concerning the billing, collecting, crediting and adjusting of the customer service charges, except prior customer balances due from end users, in accordance with written instructions furnished by the customer. At the request of the customer when the customer has ordered inquiry, the billed customer messages which are removed from an end user's bill in accordance with customer inquiry instructions will be reviewed for unauthorized use of customer service by Telephone Company message investigation groups for a period of up to 90 days after the billed customer message has been removed from an end user's bill. For any billed customer messages removed from an end user's bill in accordance with customer inquiry instructions, the Telephone Company will make appropriate adjustments to the customer's accounts receivable. When the Telephone Company provides Bill Rendering Service without inquiry, all contacts from customer end users concerning the customer billed amounts will be referred to the customer, and the Telephone Company will only be responsible for contacts with customer's end users concerning the collection of customer service deposits and charges, except prior customer balances due from end users. Inquiry will only be provided when the customer is provided Bill Rendering Service at the same time for the same state operating area.

(T)

(T)

(T)

(T)

(T)

PUBLIC SERVICE COMMISSION  
OF KENTUCKY  
EFFECTIVE

MAY 23 1995

PURSUANT TO 807 KAR 5:011,  
SECTION 9(1)

BY: Jordan C. Neal  
FOR THE PUBLIC SERVICE COMMISSION

Issued: June 13, 1995

Effective: May 23, 1995

President, Cincinnati, Ohio

*Deborah A. Nisch*

Vice President  
Integrated Corporate Planning for

ACCESS SERVICE TARIFF  
PSCK No. 2

CINCINNATI BELL TELEPHONE COMPANY

1st Revised Page 401  
Cancels Original Page 401

8. Billinn and Collection Services (Cont'd)

8.2 Billinn Service (Cont'd)

8.2.1 Messane Billinn Service (Cont'd)

(B) Undertakinn of the Telephone Company (Cont'd)

(2) Bill Rendering Service (Cont'd)

(T)

(j) The Telephone Company will accept customer gift certificates for payment from end users if the customer agrees in writing to redeem all such gift certificates. The format of the gift certificate must be acceptable to the Telephone Company.

(k) Rated customer messages input to Bill Rendering Service which the Telephone Company cannot bill for any reason will be reviewed by the Telephone Company's message investigation groups. Upon completion of the review, the billable messages will be posted and the appropriate charges, as set forth in (G)(7) and (G)(8) following, will apply. Unbillable messages will be handled in accordance with instructions that have been mutually determined by the Telephone Company and the customer. At the request of the customer, the rated customer messages which cannot be billed to an end user will be reviewed for unauthorized use of customer service by Telephone Company message investigation groups for a period of up to 90 days after the rated customer message was processed. (T)

PUBLIC SERVICE COMMISSION  
OF KENTUCKY  
EFFECTIVE

MAY 23 1995

PURSUANT TO 807 KAR 5011,  
SECTION 9 (1)

BY: Jordan C. Neel  
FOR THE PUBLIC SERVICE COMMISSION

Issued: June 13, 1995

Effective: May 23, 1995

  
President, Cincinnati, Ohio  
Vice President  
Integrated Corporate Planning for

ACCESS SERVICE TARIFF  
PSCK No. 2

CINCINNATI BELL TELEPHONE COMPANY

1st Revised Page 402  
Cancels Original Page 402

8. Billing and Collection Services (Cont'd)

8.2 Billing Service (Cont'd)

8.2.1 Message Billinn Service (Cont'd)

(B) Undertaking of the Telephone Company (Cont'd)

(2) Bill Rendering Service (Cont'd)

- (1) The Telephone Company will post rated customer messages to the appropriate end user account when it identifies a customer message to be billed to an end user.

(T)

(D)

(D)

Other customer message-related charges, such as directory assistance and DIAL-IT charges, will be billed to the end user based on customer message data received from Message Processing Service or from the customer. The Telephone Company will make adjustments to end user balances due to account for application of credits authorized by customer inquiry instructions and customer furnished statements.

- (m) The Telephone Company will establish an end user account for customer bulk-billed service when it receives an order from a customer to perform such activity for a specific end user and will bill customer bulk-billed charges to the end user.  
The Telephone

PUBLIC SERVICE COMMISSION  
OF KENTUCKY  
EFFECTIVE

MAY 23 1995

PURSUANT TO 807 KAR 5:011,  
SECTION 9.1)

BY: Jordan C. Neel  
FOR THE PUBLIC SERVICE COMMISSION

Issued: **June 13, 1995**

Effective: **May 23, 1995**

*Deborah A. Nisch*  
President, Cincinnati, Ohio  
Vice President  
Integrated Corporate Planning for

ACCESS SERVICE TARIFF  
PSCK No. 2

CINCINNATI BELL TELEPHONE COMPANY

1st Revised Page 403  
Cancels Original Page 403

8. Billinn and Collection Services (Cont'd)

8.2 Billing Service (Cont'd)

8.2.1 Message Billinn Service (Cont'd)

(B) Undertaking of the Teleuhone Company (Cont'd)

(2) Bill Rendering Service (Cont'd)

(T)

(m) (Cont'd)

Company will bill other customer bulk-billed rate elements, such as provision of a bulk-billed service access line, installation of an access line and provision of an access line extension, when it receives a Special Order for such services from a customer. Other customer message-related charges for bulk-billed service, such as directory assistance and DIAL-IT charges, will be billed to the end user based on customer message data received from Message Processing Service or from the customer. The Telephone Company will make adjustments to end user balances due to account for application of credits authorized by customer inquiry instructions and customer furnished statements.

PUBLIC SERVICE COMMISSION  
OF KENTUCKY  
EFFECTIVE

(n) Where the rates for customer services have been implemented under an accounting order pending final approval from a regulatory agency, the Telephone Company will, upon written request from the customer, keep such records as may be required to make any adjustments to the end users as may be ordered by the regulatory agency. The charges for such a service will be determined on an individual case basis.

MAY 23 1995

PURSUANT TO 807 KAR 5611,  
SECTION 9(1)

BY: Jordan C. Neel  
FOR THE PUBLIC SERVICE COMMISSION

(3) Message Billinn Service Ordering

(a) The Telephone Company will provide Message Billing Services under a Special Order. For all Message Billing Service, other than establishment of or changes to end user account data establishment of or changes to end user account rate elements and changes to end user balance due, the Message Billing Service Special Order charge as set forth in (G)(14) following will apply to orders

(C)

Issued: June 13, 1995

Effective: May 23, 1995

  
Deborah A. Disen, President, Cincinnati, Ohio  
Vice President  
Integrated Corporate Planning for

ACCESS SERVICE TARIFF  
PSCK No. 2

CINCINNATI BELL TELEPHONE COMPANY

1st Revised Page 404  
Cancels Original Page 404

8. Billinn and Collection Services (Cont'd)

8.2 Billing Service (Cont'd)

8.2.1 Messane Billinn Service (Cont'd)

(B) Undertaking of the Telephone Company (Cont'd)

(3) Messane Billing Service Ordering (Cont'd)

(a) (Cont'd)

accepted by the Telephone Company. The format of this Special Order will be specified by the Telephone Company.

PUBLIC SERVICE COMMISSION  
OF KENTUCKY  
EFFECTIVE

MAY 23 1995

PURSUANT TO 807 KAR 501.1,  
SECTION 9 (1)

BY: Justin C. Neel  
FOR THE PUBLIC SERVICE COMMISSION

- (b) The Telephone Company will arrange with the customer to accept under a Special Order end user account information to establish and change end user account data, establish and change end user account rate elements and change end user balances due. The methods, procedures and manner in which the end user account data and changes are forwarded to the Telephone Company must be agreeable to the Telephone Company. The charges to handle such Special Orders will be determined on an individual case basis. (C)

(C) Liability of the Telephone Company

Notwithstanding 2.1.3 preceding, the Telephone Company liability for Message Billing Service is as follows:

- (1) If Bill Rendering Service detail is not available because the Telephone Company lost or damaged records or incurred processing system outages, the Telephone Company will attempt to recover the lost customer detail. If the lost customer detail cannot be recovered and the Telephone Company recorded the details, the customer detail and the extent of the Telephone Company's liability for damages will be set forth in 8.1.3(B) preceding. If the lost customer detail cannot be recovered and the customer provided the detail, the customer will be requested to resupply the detail. If the customer cannot resupply the detail, the detail and the extent of the Telephone (T) (C)

Issued: June 13, 1995

Effective: May 23, 1995

Deborah A. Wisch President, Cincinnati, Ohio  
Vice President  
Integrated Corporate Planning for

ACCESS SERVICE TARIFF  
PSCK No. 2

CINCINNATI BELL TELEPHONE COMPANY

1st Revised Page 405  
Cancels *Original* Page 405

8. Billing and Collection Services (Cont'd)

8.2 Billing Service (Cont'd)

8.2.1 Message Billing Service (Cont'd)

(C) Liability of the Telephone Company (Cont'd)

(1) (Cont'd)

Company's liability for damages will be as set forth in 8.1.3 preceding. This recovered detail will be included in message detail provided to the customer when the customer orders such service and any recovered customer messages will be billed. (C)

(2) When the Telephone Company is notified that, due to its error or omission, incomplete customer detail has been provided, as set forth in 8.2.1(B)(1)(j) preceding and/or 8.4 following, to a customer, the Telephone Company will make a reasonable effort to recover and provide the customer detail to the customer at no additional charge. Such request to recover the customer detail must be made within 30 days from the date the customer detail was initially made available to the customer. If the detail cannot be recovered, the extent of the Telephone Company's liability for damages shall be limited as set forth in 8.1.3 preceding. (C)

(3) If the Telephone Company finds, or is notified of, an error in billing to an end user, it will make a reasonable effort to correct the error and bill the appropriate end user within the limits permitted by laws of the state in which it provides the service. If the error is caused by the Telephone Company and the Telephone Company cannot bill the proper end user in a timely manner, the extent of the Telephone Company's liability for damages will be the known amount misbilled or when the amount misbilled is unknown, limited as set forth in 8.1.3. (C)

(4) In the absence of willful misconduct, no liability for damages to the customer or other person or entity other than as set forth in (1), (2) and (3) preceding shall attach to the Telephone Company for its action or the conduct of its employees in providing Message Billing Service.

PUBLIC SERVICE COMMISSION  
OF KENTUCKY  
EFFECTIVE

MAY 23 1995

PURSUANT TO 807 KAR 5.011,  
SECTION 9(1)

BY: Jordan C. Neal  
FOR THE PUBLIC SERVICE COMMISSION

Issued: June 13, 1995

Effective: May 23, 1995

Deborah A. Nisch President, Cincinnati, Ohio  
Vice President  
Integrated Corporate Planning for

8. Billing and Collection Services (Cont'd)

8.2 Billing Service (Cont'd)

8.2.1 Message Billing Service (Cont'd)

(D) Obligations of the Customer

- (1) The customer shall order Message Billing Services under a Special Order for each state where service is desired. The customer shall be responsible for all balances due from end users that exist prior to ordering Bill Rendering Service. (T)

At the time Message Processing Service and/or Bill Rendering Service is initially ordered, the customer shall order the service for 1 year. Thereafter, upon written notice, additional service may be ordered for additional years at the rates and charges as set forth in (G) following. The customer may order inquiry for a service period that is different from that for Bill Rendering. However, the customer shall not order inquiry unless it also has ordered Bill Rendering Service for the same period and the same state operating area. Not later than three months prior to the end of an order period, the customer shall notify the Telephone Company in writing if any service is to be discontinued at the end of the period. If no notice is received from the customer, the Telephone Company will automatically extend the services for another year, using the most recent 12 months of capacity provided. The customer will be notified by the Telephone Company when such an extension is made. All appropriate charges, as set forth in (G) following, for another year will apply and the minimum charges will be based on the most recent 12 months of message capacity and/or bill capacity provided. (T)  
(C)  
(C)  
(T)  
(T)  
(C)

PUBLIC SERVICE COMMISSION  
OF KENTUCKY  
EFFECTIVE

MAY 23 1995

PURSUANT TO 807 KAR 5011,  
SECTION 9 (1)

BY: Jordan C. Neal  
FOR THE PUBLIC SERVICE COMMISSION

- (2) When Message Processing Service is ordered, the customer shall furnish the Telephone Company, for each state and for each user in the order, an estimate of the number of messages (message capacity), including those messages which will be bulk billed, to be processed. (T)

Issued: June 13, 1995

Effective: **May 23, 1995**

*Deborah A. Nisich* President, Cincinnati, Ohio

Vice President  
Integrated Corporate Planning for

ACCESS SERVICE TARIFF  
PSCK No. 2

CINCINNATI BELL TELEPHONE COMPANY

1st Revised Page 407  
Cancels Original Page 407

8. Billinn and Collection Services (Cont'd)

8.2 Billing Service (Cont'd)

8.2.1 Messane Billing Service (Cont'd)

(D) Oblinations of the Customer (Cont'd)

(2) (Cont'd)

In addition, when Bill Rendering Service is ordered, (T)  
the customer shall furnish the Telephone Company, for  
each state and for each year in the order, an  
estimate of the number of message-billed and/or  
bulk-billed messages (bill capacity) for which  
billing is to be provided. Separate estimates  
shall be furnished by the customer for message-billed  
messages and bulk-billed messages. The capacity  
estimate for inquiry for each state and each year  
shall be the same as that for message-billed and/or  
bulk-billed messages.

- (3) The customer shall furnish all information necessary  
for the Telephone Company to provide the Message  
Billing Service, including any per month service  
charges applicable to an end user and an affidavit  
that states whether the customer service is subject  
to any Federal taxes and/or State taxes. When  
customer messages are to be billed by an entity  
other than the Telephone Company, the customer shall  
furnish written instructions as to how the rated  
customer messages are to be provided to that other  
entity. If the customer does not furnish complete  
instructions, all resulting unbillable messages will  
be delivered to the customer. The information shall  
be furnished by the customer in a timely manner.

PUBLIC SERVICE COMMISSION  
OF KENJUCKY  
EFFECTIVE

MAY 23 1995

PURSUANT TO 807 KAR 5:011,  
SECTION 9(1)

BY: Jordan C. Neel  
FOR THE PUBLIC SERVICE COMMISSION

Issued: June 13, 1995

Effective: ~~May~~ 23, 1995

 Deborah A. Nisen, President, Cincinnati, Ohio  
Vice President  
Integrated Corporate Planning for



8. Billing and Collection Services (Cont'd)

8.2 Billing Service (Cont'd)

8.2.1 Message Billing Service (Cont'd)

(D) Obligations of the Customer (Cont'd)

- (4) The customer shall furnish to the Telephone Company a written schedule of its rates and charges in sufficient time to allow the Telephone Company to establish a rating program. The customer's rate structure must be consistent with established Telephone Company rating methodologies. The interval required to establish a rating program must be mutually agreeable to the Telephone Company and the customer.
- (5) (Reserved)
- (6) The customer shall be responsible for all contact and arrangements, with its end users concerning the provision and maintenance of the customer's service, including prior customer balances due from end users.

PUBLIC SERVICE COMMISSION  
OF KENTUCKY  
EFFECTIVE

MAR 3 1992

PURSUANT TO 807 KAR 5:011,  
SECTION 9 (1)

BY: George Bell  
PUBLIC SERVICE COMMISSION MANAGER

Effective: March 3, 1992

Issued: February 7, 1992  
Robert E. Symon FOR

President, Cincinnati, Ohio

Vice President - Regulatory Affairs

ACCESS SERVICE TARIFF  
PSCK No. 2

CINCINNATI BELL TELEPHONE COMPANY

1st Revised Page 409  
Cancels Original Page 409

8. Billinn and Collection Services (Cont'd)

8.2 Billinn Service (Cont'd)

8.2.1 Message Billinn Service (Cont'd)

(D) Oblinations of the Customer (Cont'd)

- (7) When the customer orders message-billed or bulk-billed Bill Rendering Service with inquiry, the customer shall furnish to the Telephone Company written instructions, which are agreeable to the Telephone Company, for the handling of end user questions about bills. (T)

When the customer orders message-billed or bulk-billed Bill Rendering Service without inquiry, the customer shall furnish the Telephone Company with written instructions as to where inquiries are to be referred. (T)

PUBLIC SERVICE COMMISSION  
OF KENTUCKY  
EFFECTIVE

MAY 23 1995

PURSUANT TO 807 KAR 5.011,  
SECTION 9 (1)

BY: Jordan C. Neal  
FOR THE PUBLIC SERVICE COMMISSION

When the customer does not order inquiry service and desires credit adjustments be made to the end user balance due, the customer shall furnish a statement for each end user account where the credit is desired. These statements shall show the customer message, the date the customer message was billed and the amount of the credit. These statements shall be furnished to the Telephone Company under a Special Order as set forth in (B)(3)(b) preceding.

The customer shall notify its end users through its tariff or other appropriate means when the customer handles the bill inquiries. The customer shall furnish the Telephone Company in writing all end user bill adjustment statements.

- (8) The customer will immediately redeem all customer gift certificates the Telephone Company receives in payment for any end user charges. The customer agrees to use a gift certificate format which is agreeable to the Telephone Company.
- (9) The customer agrees to permit the Telephone Company to, when necessary in accordance with Telephone Company deposit regulations, determine and collect customer

Issued: June 13, 1995

Effective: May 23, 1995

Deborah A. Nisab President, Cincinnati, Ohio  
Vice President  
Integrated Corporate Planning for

ACCESS SERVICE TARIFF  
PSCK No. 2

CINCINNATI BELL TELEPHONE COMPANY

1st Revised Page 410  
Cancels Original Page 410

8. Billing and Collection Services (Cont'd)

8.2 Billing Service (Cont'd)

8.2.1. Message Billing Service (Cont'd)

(D) Obligations of the Customer (Cont'd)

(9) (Cont'd)

service deposits from all end users of the customer services for which the Telephone Company provides billing for the customer. The customer will notify its end users through its tariffs or other means that the Telephone Company will, when necessary in accordance with Telephone Company deposit regulations, determine and collect customer service deposits, The customer will also include in its tariff and service arrangements and obtain regulatory concurrence for the Telephone Company deposit regulations that the Telephone Company will use to determine and collect end user service deposits.

(10)

PUBLIC SERVICE COMMISSION  
OF KENTUCKY  
EFFECTIVE

MAY 23 1995

PURSUANT TO 807 KAR 5:011,  
SECTION 9 (1)

BY: Jordan C. Neel  
FOR THE PUBLIC SERVICE COMMISSION

(D)

(D)

(11) When the customer furnishes recorded customer detail for Message Processing Service and/or rated customer message detail for Bill Rendering Service, it shall be responsible to deliver the detail to the location specified by the Telephone Company and it shall retain a copy of the detail furnished for at least 90 days.

(T)

Issued: June 13, 1995

Effective: May 23, 1995

*Deborah A. Nisch* President, Cincinnati, Ohio

Vice President  
Integrated Corporate Planning for

8. Billing and Collection Services (Cont'd)

8.2 Billing Service (Cont'd)

8.2.1 Message Billing Service (Cont'd)

(E) Payment Arranaements and Audit Provision

(1) Audit Provision

Upon written notice by the customer to the Telephone Company, the customer shall have the right, through its authorized representative, to examine and audit, during normal business hours and at reasonable intervals determined by the Telephone Company, all such records and accounts as may under recognized accounting practices contain information bearing upon the amount payable to the customer. Adjustment shall be made by the proper party to compensate for any errors or omissions disclosed by such examination or audit. Neither such right to examine and audit nor the right to receive such adjustment shall be affected by any statement to the contrary, appearing on checks or otherwise, unless such statement expressly waiving such right appears in a letter signed by the authorized representative of the party having such right and delivered to the other party.

Any information received or reviewed by the customer or its authorized representative during the audit is to be considered confidential and not to be distributed, provided or disclosed in any form to anyone not involved in the audit, nor is such information to be used for any other purpose.

**PUBLIC SERVICE COMMISSION  
OF KENTUCKY  
EFFECTIVE**

MAR 3 1992

**PURSUANT TO 807 KAR 5:011,  
SECTION 9 (1)**

BY: *Shawndelle*  
PUBLIC SERVICE COMMISSION MANAGER

Effective: March 3, 1992

Issued: F b y 7, 1992

*Robert E. Aigmon* for

President, Cincinnati, Ohio

**Vice President - Regulatory Affairs**

ACCESS SERVICE TARIFF  
PSCK No. 2

CINCINNATI BELL TELEPHONE COMPANY

1st Revised Page 412  
Cancels **Original** Page 412

8. Billinn and Collection Senrices (Cont'd)

8.2 Billing Service (Cont'd)

8.2.1 Hessane Billing Service (Cont'd)

(E) Payment Arrannements and Audit Provision (Cont'd)

(2) Minimum Period

The minimum period for which Message Billing Service is provided and for which charges apply is one year. If the customer orders Message Processing Service and/or Bill Rendering Service for 1 year, then the minimum period and the period for which charges apply is that period ordered by the customer. A minimum period of 1 year, as ordered by the customer, applies for each additional period of service ordered.

(T)

(C)

If the service is discontinued prior to the end of the period ordered, monthly charges apply for each remaining month and fraction of a month. The monthly charge will be one-twelfth of the minimum yearly charge.

PUBLIC SERVICE COMMISSION  
OF KENTUCKY  
EFFECTIVE

MAY 23 1995

PURSUANT TO 807 KAR 5:011,  
SECTION 9(1)

BY: Jordan C. Neel  
FOR THE PUBLIC SERVICE COMMISSION

Issued: June 13, 1995

Effective: May 23, 1995

  
Deborah A. Nisele, President, Cincinnati, Ohio  
Vice President  
Integrated Corporate Planning for

ACCESS SERVICE TARIFF  
PSCK No. 2

CINCINNATI BELL TELEPHONE COMPANY

1st Revised Page 413  
Cancels Original Page 413

8. Billing and Collection Services (Cont'd)

8.2 Billing Service (Cont'd)

8.2.1 Message Billinn Service (Cont'd)

(E) Payment Arrannements and Audit Provision (Cont'd)

(3)

(D)

PUBLIC SERVICE COMMISSION  
OF KENTUCKY  
EFFECTIVE

MAY 23 1995

PURSUANT TO 807 KAR 5.011,  
SECTION 9(1)  
BY: Jordan C. Neel  
FOR THE PUBLIC SERVICE COMMISSION

(D)

Issued: June 13, 1995

Effective: May 23, 1995

*Deborah A. Risch* President, Cincinnati, Ohio  
Vice President  
Integrated Corporate Planning for

ACCESS SERVICE TARIFF  
PSCK No. 2

CINCINNATI BELL TELEPHONE COMPANY

1st Revised Page 414  
Cancels Original Page 414

8. Billing and Collection Services (Cont'd)

8.2 Billing Service (Cont'd)

8.2.1 Message Billing Service (Cont'd)

(E) Payment Arrangements and Audit Provision (Cont'd)

(3)

(D)

(D)

PUBLIC SERVICE COMMISSION  
OF KENTUCKY  
EFFECTIVE

MAY 23 1995

PURSUANT TO 807 KAR 5:011,  
SECTION 9(1)

BY: Jordan C. Neal  
FOR THE PUBLIC SERVICE COMMISSION

Issued: **June 13, 1995**

Effective: **May 23, 1995**

*Deborah A. Nisch*

President, Cincinnati, Ohio

Vice President  
Integrated Corporate Planning for

ACCESS SERVICE TARIFF  
PSCK No. 2

CINCINNATI BELL TELEPHONE COMPANY

1st Revised Page 415  
Cancels Original Page 415

8. Billing and Collection Services (Cont'd)

8.2 Billing Service (Cont'd)

8.2.1 Messane Billing Service (Cont'd)

(E) Payment Arrangements and Audit Provision (Cont'd)

(3)

(D)

PUBLIC SERVICE COMMISSION  
OF KENTUCKY  
EFFECTIVE

MAY 23 1995

PURSUANT TO 807 KAR 5.011,  
SECTION 9(1)

BY: Jordan C. Neal  
FOR THE PUBLIC SERVICE COMMISSION

(D)

Issued: June 13, 1995

Effective: May 23, 1995

*Deborah A. Nisch* President, Cincinnati, Ohio  
Vice President  
Integrated Corporate Planning for



ACCESS SERVICE TARIFF  
PSCK No. 2

CINCINNATI BELL TELEPHONE COMPANY

1st Revised Page 416  
Cancels Original Page 416

8. Billinn and Collection Services (Cont'd)

8.2 Billinn Service (Cont'd)

8.2.1 Messane Billinn Service (Cont'd)

(E) Payment Arrangements and Audit Provision (Cont'd)

(3)

(D)

PUBLIC SERVICE COMMISSION  
OF KENTUCKY  
EFFECTIVE

MAY 23 1995

(D)

PURSUANT TO 807 KAR 5.011,  
SECTION 9(1)

BY: Jordan C. Neal  
FOR THE PUBLIC SERVICE COMMISSION

Issued: June 13, 1995

Effective: May 23, 1995

*Deborah A. Nisch* president, Cincinnati, Ohio  
Vice President  
Integrated Corporate Planning for

ACCESS SERVICE TARIFF  
PSCK No. 2

CINCINNATI BELL TELEPHONE COMPANY

1st Revised Page 417  
Cancels Original Page 417

8. Billinn and Collection Services (Cont'd)

8.2 Billinn Service (Cont'd)

8.2.1 Messane Billinn Service (Cont'd)

(E) Payment Arrangements and Audit Provision (Cont'd)

(3)

(D)

PUBLIC SERVICE COMMISSION

(D)

MAY 23 1995

PURSUANT TO 807 KAR 5:011,  
SECTION 9(1)

BY: Jordan C. Neel  
FOR THE PUBLIC SERVICE COMMISSION

Issued: June 13, 1995

Effective: May 23, 1995

*Deborah A. Nisch*

President, Cincinnati, Ohio

Vice President  
Integrated Corporate Planning for

ACCESS SERVICE TARIFF  
PSCK No. 2

CINCINNATI BELL TELEPHONE COMPANY

Original Page 418

8. Billing and Collection Services (Cont'd)

8.2 Billing Service (Cont'd)

8.2.1 Message Billing Service (Cont'd)

(E) Payment Arrangements and Audit Provision (Cont'd)

(4) Cancellation of a Special Order

A customer may cancel a Special Order for Message Billing Service on any date prior to the service date. The cancellation date is the date the Telephone Company receives written or verbal notice from the customer that the Special Order is to be cancelled. The verbal notice must be followed by written confirmation within 10 days. The service date for Message Billing Service is the date the customer and the Telephone Company mutually agree the service is to start.

When a customer cancels a Special Order for Message Billing Service after the order date, but prior to the start of service, a charge equal to the Special Order charges, program development costs and any nonrecoverable capital costs incurred by the Telephone Company will apply to the customer.

PUBLIC SERVICE COMMISSION  
OF KENTUCKY  
EFFECTIVE

MAR 3 1992

PURSUANT TO 807 KAR 5:011,  
SECTION 9 (1)

BY: George Deller

PUBLIC SERVICE COMMISSION MANAGER  
Effective: March 3, 1992

Issued: February 7, 1992

Robert E. Aigmon

for

President, Cincinnati, Ohio

Vice President - Regulatory Affairs

ACCESS SERVICE TARIFF  
PSCK No. 2

CINCINNATI BELL TELEPHONE COMPANY

1st Revised Page 419  
Cancels Original Page 419

8. Billinn and Collection Services (Cont'd)

8.2 Billinn Service (Cont'd)

8.2.1 Message Billinn Service (Cont'd)

(E) Payment Arrangements and Audit Provision (Cont'd)

(5) Channes to Special Orders

When a customer requests changes to a pending Special Order for Message Billing Service, such changes will be undertaken if they can be accommodated by the Telephone Company. A charge equal to any costs incurred by the Telephone Company because of the change will apply.

(F) Rate Regulations

- (1) The Message Processing and Bill Rendering Service message charges apply during the yearly periods ordered by the customer. The Telephone Company will not initiate rate changes to the Message Processing Service charges as set forth in (G)(1) following or the Bill Rendering Service charges as set forth in (G)(7) following that apply to the customer order during the yearly periods for that specific order. For the purpose of determining the charges applicable to bulk-billed service for Bill Rendering Service, a bulk-billed message is a customer message which is used by the Telephone Company to develop the customer bulk-billed charge.

(2)

PUBLIC SERVICE COMMISSION  
OF KENTUCKY  
EFFECTIVE

MAY 23 1995

PURSUANT TO 807 KAR 5:011,  
SECTION 9 (1)

BY: Jordan C. Neel  
FOR THE PUBLIC SERVICE COMMISSION

Issued: June 13, 1995

Effective: May 23, 1995

*Deborah A. Nisch*

President, Cincinnati, Ohio

Vice President  
Integrated Corporate Planning for

ACCESS SERVICE TARIFF  
PSC No. 2

CINCINNATI BELL TELEPHONE COMPANY

1st Revised Page 420  
Cancels Original Page 420

8. Billinn and Collection Services (Cont'd)

8.2 Billinn Service (Cont'd)

8.2.1 Messane Billinn Service (Cont'd)

(F) Rate Regulations (Cont'd)

(2) (Cont'd)

(D)

(D)

PUBLIC SERVICE COMMISSION  
OF KENTUCKY  
EFFECTIVE

MAY 23 1995  
PURSUANT TO 807 KAR 5.011,  
SECTION 9 (1)  
BY: Jordan C. Neal  
FOR THE PUBLIC SERVICE COMMISSION

Issued: ~~June 13, 1995~~

Effective: ~~May 23, 1995~~

*Deborah A. Nisch*

President, Cincinnati, Ohio

Vice President  
Integrated Corporate Planning for

ACCESS SERVICE TARIFF  
PSCK No. 2

CINCINNATI BELL TELEPHONE COMPANY

1st Revised Page 421  
Cancels Original Page 421

8. Billinn and Collection Services (Cont'd)

8.2 Billinn Service (Cont'd)

8.2.1 Messane Billinn Service (Cont'd)

(P) Rate Regulations (Cont'd)

(2) (Cont'd)

(D)

PUBLIC SERVICE COMMISSION  
OF KENTUCKY  
EFFECTIVE

(D)

MAY 23 1995

PURSUANT TO 807 KAR 5:011,  
SECTION 9 (1)

BY: Jordan C. Neel  
FOR THE PUBLIC SERVICE COMMISSION

Issued: June 13, 1995

Effective: **May 23, 1995**

*Deborah A. Nisch* President, Cincinnati, Ohio  
Vice President  
Integrated Corporate Planning for

ACCESS SERVICE TARIFF  
PSCK No. 2

CINCINNATI BELL TELEPHONE COMPANY

Original Page 422

8. Billing and Collection Services (Cont'd)

8.2 Billing Service (Cont'd)

8.2.1 Message Billing Service (Cont'd)

(F) Rate Regulations (Cont'd)

- (3) The Message-Billed Service charge applies each month that one or more messages or related rate elements are billed to an end user. When both interstate and state customer messages are billed by the Telephone Company to the end user on the same bill for the customer, the Message Billed Service charge times 0.5 applies each month. When more than one copy of the end user bill is provided to the end user, the Message-Billed Service charge applies for each additional copy of the end user bill provided.
- (4) A Bulk-Billed Service charge applies each month that one or more bulk-billed charges are billed to an end user. When both interstate and state customer bulk-billed charges are billed by the Telephone Company to the end user on the same bill for the customer, the Bulk-Billed Service charge times 0.5 applies each month. When more than one copy of the end user bill is provided to the end user, the Bulk-Billed Service charge applies for each additional copy of the end user bill provided.
- (5) When message detail is data-transmitted to or received from an Exchange Telephone Company location by the Telephone Company, a charge as set forth in (G)(4) following, on a per record basis will apply. A record is a logical grouping of information as described in the program that processes the information and loads the magnetic tape or data file used to supply the message detail which is data-transmitted. The Telephone Company will determine this charge based on its count of the records transmitted.

PUBLIC SERVICE COMMISSION  
OF KENTUCKY  
EFFECTIVE

MAR 3 1992

PURSUANT TO 807 KAR 5:011,  
SECTION 9(1)

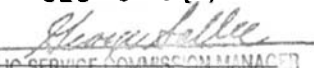
BY:   
PUBLIC SERVICE COMMISSION MANAGER  
Effective: March 3, 1992

Issued: February 7, 1992

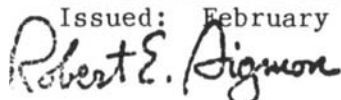
 for  
President, Cincinnati, Ohio

Vice President - Regulatory Affairs

ACCESS SERVICE TARIFF  
PSCK No. 2

CINCINNATI BELL TELEPHONE COMPANY

1st Revised Page 423  
Cancels *Original* Page 423

8. Billinn and Collection Services (Cont'd)

8.2 Billinn Service (Cont'd)

8.2.1 Message Billinn Service (Cont'd)

(P) Rate Regulations (Cont'd)

(6) When message detail is data-transmitted to or received from a customer location by the Telephone Company, a charge, as set forth in (G)(4) following, will apply. A record is a logical grouping of information as described in the program that processes the information and loads the magnetic tape or data file used to supply the message detail which is data-transmitted. The Telephone Company will determine this charge based on its count of the records transmitted and/or received. (C)

(7) The Message Billing Service Special Order charge applies for each Special Order for Message Processing Service and/or Bill Rendering Service, other than establishment of or changes to end user account data, establishment of or changes to end user account rate elements and changes to end user balances due, accepted by the Telephone Company. (T)  
(C)

PUBLIC SERVICE COMMISSION  
OF KENTUCKY  
EFFECTIVE

MAY 23 1995

PURSUANT TO 807 KAR 5.011,  
SECTION 9(1)

BY: Jordan C. Neal  
FOR THE PUBLIC SERVICE COMMISSION

The End User account activity charges apply whenever a customer Special Order requests end user account data be established or changed, nonrecurring or recurring customer rate element be added or changed in an end user account and/or an end user balance due be changed.

An end user account is a record for message-billed service or a bulk-billed service which has a unique name and address and billing identification number, assigned by the Telephone Company, to which a bill is rendered.

The end user account activity Special Order charge always applies and the end user account establishment and change charge, end user account rate element rate level change charge or the end user account rate element rate structure change charge may apply depending on the activity ordered by the customer as set forth in (a), (b), (c) and (d) following.

Issued: June 13, 1995

Effective: May 23, 1995

 President, Cincinnati, Ohio  
Vice President  
Integrated Corporate Planning for



ACCESS SERVICE TARIFF  
PSCK No. 2

CINCINNATI BELL TELEPHONE COMPANY

1st Revised Page 424  
Cancels Original Page 424

8. Billing and Collection Services (Cont'd)

8.2 Billing Service (Cont'd)

8.2.1 Message Billing Service (Cont'd)

(F) Rate Regulations (Cont'd)

(7) (Cont'd)

(a) The end user account activity Special Order charge applies whenever the customer furnishes to the Telephone Company end user account information that establishes or changes the information, rates or balance due associated with an end user account.

(b) The end user account establishment and change charge applies whenever customer furnished information is used by the Telephone Company to establish or change end user account data or rate elements, or balances due, except for information to change end user account rate element rate levels or rate structure. End user account rate element rate level and rate structure change charges are applied as set forth in (c) and (d) following.

PUBLIC SERVICE COMMISSION  
OF KENTUCKY  
EFFECTIVE

MAY 23 1995

PURSUANT TO 807 KAR 5:011,  
SECTION 9 (1)

BY: *Stephen C. Neel*  
FOR THE PUBLIC SERVICE COMMISSION

In addition, the end user account establishment and change charge does not apply when rated customer messages are posted to a message-billed account associated with an end user common line.

The end user account establishment and change charge applies for each account established, rate element established, account changed, rate element changed and balance due changed.

(D)

(D)

(C)

Issued: June 13, 1995

Effective: May 23, 1995

*Deborah A. Nisch* President, Cincinnati, Ohio  
Vice President  
Integrated Corporate Planning for

ACCESS SERVICE TARIFF  
PSCK No. 2

CINCINNATI BELL TELEPHONE COMPANY

Original Page 425

8. Billing and Collection Services (Cont'd)

8.2 Billing Service (Cont'd)

8.2.1 Message Billing Service (Cont'd)

(F) Rate Regulations (Cont'd)

- (c) The end user account rate element rate level change charge applies whenever customer furnished information is used by the Telephone Company to change an end user account rate element rate level. The charge applies for each end user account rate element rate level changed.
- (d) The end user account rate element rate structure change charge applies whenever customer furnished information is used by the Telephone Company to change an end user account rate element rate structure. The charges to make the end user account rate element rate structure changes will be determined on an individual case basis.

**PUBLIC SERVICE COMMISSION  
OF KENTUCKY  
EFFECTIVE**

MAR 3 1992

**PURSUANT TO 807 KAR 5:011.  
SECTION 9 (1)**

BY:   
PUBLIC SERVICE COMMISSION MANAGER

Issued: February 7, 1992

Effective: March 3, 1992

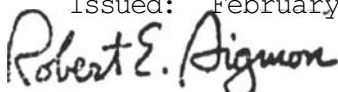
 for

President, Cincinnati, Ohio

**Vice President - Regulatory Affairs**

ACCESS SERVICE TARIFF  
PSCK No. 2

CINCINNATI BELL TELEPHONE COMPANY

1st Revised Page 426  
Cancels Original Page 426

8. Billing and Collection Services (Cont'd)

8.2 Billing Service (Cont'd)

8.2.1 Messane Billing Service (Cont'd)

(F) Rate Regulations (Cont'd)

- (8) When message detail is entered on a data file or magnetic tape to be provided to a customer, the per tape charge applies for each data file or tape prepared and the per record charge applies for each record processed. A record is a logical grouping of information as described in the programs that process the information and load the magnetic tapes or data file. The Telephone Company will determine the charges based on the number of data files or tapes prepared and on its count of the records processed. The number of records processed will be determined using the number of records input to or the number of records output from the programs that process the information and load the magnetic tapes or data files whichever number of records is higher.
- (9) The rates as set forth in (G)(7) apply for Bill Rendering Service for a customer message-billed service depending on the total (i.e., sum of interstate and intrastate customer messages) number of messages billed for a customer per month. The rate groups are the first 1 to 5,000 messages per month, the next 5,001 to 45,000 messages per month, the next 45,001 to 50,000 messages per month, the next 50,001 to 650,000 messages per month and over 650,000 messages per month. (T)  
(C)  
(C)

PUBLIC SERVICE COMMISSION  
OF KENTUCKY  
EFFECTIVE

MAY 23 1995

PURSUANT TO 807 KAR 5:011,  
SECTION 9(1)

BY: Jordan C. Neel  
FOR THE PUBLIC SERVICE COMMISSION

Issued: June 13, 1995

Effective: **May** 23, 1995

  
Deborah A. Nisch, President, Cincinnati, Ohio  
Vice President  
Integrated Corporate Planning for

ACCESS SERVICE TARIFF  
PSCK No. 2

CINCINNATI BELL TELEPHONE COMPANY

1st Revised Page 427  
Cancels Original Page 427

8. Billinn and Collection Services (Cont'd)

8.2 Billinn Service (Cont'd)

8.2.1 Messane Billing Service (Cont'd)

(F) Rate Regulations (Cont'd)

(10)

(D)

(D)

(11) The rate for program development is for the use of one hour of one Telephone Company programmer's time as set forth in 8.2.1 (G) following.

(C)  
(T)  
(T)

(12) The Telephone Company will keep a count of the hours and fraction thereof used by Telephone Company personnel to provide program development and will bill the customer in accordance with these records. The hours for each service ordered will be summed and then rounded to the nearest hour, except that when the total is less than one hour, one hour will be used to determine the charges.

PUBLIC SERVICE COMMISSION  
OF KENTUCKY  
EFFECTIVE

MAY 23 1995

PURSUANT TO 807 KAR 5011,  
SECTION 9(1)

BY: Jordan C. Neel  
FOR THE PUBLIC SERVICE COMMISSION

Issued: June 13, 1995

Effective: May 23, 1995

*Deborah A. Nisich*

President, Cincinnati, Ohio

Vice President  
Integrated Corporate Planning for

ACCESS SERVICE TARIFF  
PSC No. 2

CINCINNATI BELL TELEPHONE COMPANY

1st Revised Page 428  
Cancels Original Page 428

8. Billinn and Collection Services (Cont'd)

8.2 Billing Service (Cont'd)

8.2.1 Message Billing Service (Cont'd)

(G) Rates and Charges

The rates and charges are:

|  | <u>Rates</u>                    | (T)  |
|--|---------------------------------|--|
| (1) Message Processing Service<br>- per message  | \$ 0.0097(R)                    | (T)<br> <br>(C)(T)<br>(D)<br>(D)                     |
| (2) Additional Message Processing,<br>- per message above the message<br>capacity ordered and<br>allowance specified | 0.0095                          | (T)  |
| (3) Program Development,<br>- per hour<br>(applicable to work performed<br>by the Telephone Company)                 | ICB rates and<br>charges apply. | (C)<br>(C)<br>(T)<br> <br>(T)<br><br>(D)<br> <br>(D) |

PUBLIC SERVICE COMMISSION  
OF KENTUCKY  
EFFECTIVE

MAY 23 1995

PURSUANT TO 807 KAR 5:011,  
SECTION 9(1)

BY: Jordan C. Neal  
FOR THE PUBLIC SERVICE COMMISSION

Issued: ~~June 13, 1995~~

Effective: **May 23, 1995**

 President, Cincinnati, Ohio  
Vice President  
Integrated Corporate Planning for

ACCESS SERVICE TARIFF  
PSCK No. 2

CINCINNATI BELL TELEPHONE COMPANY

1st Revised Page 429  
Cancels Original Page 429

8. Billinn and Collection Services (Cont'd)

8.2 Billing Service (Cont'd)

8.2.1 Messane Billinn Service (Cont'd)

(G) Rates and Charges (Cont'd)

- (4) Data transmission,  
- per record transmitted  
- per record received

RATES

\$.0070(R) (C) | (T)  
.0070(R) (C) | (T)

- (5) Provision of rated customer message  
detail,  
- per record processed  
- per tape or data file

0.0041  
55.00

(T)

(D)

(D)

PUBLIC SERVICE COMMISSION  
OF KENTUCKY  
EFFECTIVE

MAY 23 1995

PURSUANT TO 807 KAR 5:011,  
SECTION 9(1)

BY: Jordan C. Neel  
FOR THE PUBLIC SERVICE COMMISSION

Issued: **June 13, 1995**

Effective: **May 23, 1995**

  
Deborah A. Nisch, President, Cincinnati, Ohio  
Vice President  
Integrated Corporate Planning for

ACCESS SERVICE TARIFF  
PSC No. 2

CINCINNATI BELL TELEPHONE COMPANY

1st Revised Page 430  
Cancels Original Page 430

8. Billing and Collection Services (Cont'd)

8.2 Billing Service (Cont'd)

8.2.1 Message Billing Service (Cont'd)

(G) Rates and Charges (Cont'd)

(7) Bill Rendering Service,

|   | <u>Rates</u>                 |                    |                     |                      |                 | (T)               |
|---|------------------------------|--------------------|---------------------|----------------------|-----------------|-------------------|
|   | Messages billed per Customer |                    |                     |                      |                 |                   |
|   | Per Month                    |                    |                     |                      |                 |                   |
|   | 1 to<br>5.000                | 5,001 to<br>45.000 | 45,001 to<br>50.000 | 50,001 to<br>650.000 | Over<br>650.000 | (C)               |
| message-billed processing,<br>- per message | \$0.0201(R)                  | \$0.0196(R)        | \$0.0194(R)         | \$0.0191(R)          | \$0.0186(R)     | (C)<br>(D)<br>(D) |
| message-billed inquiry,<br>- per message    | 0.0954(I)                    | 0.0898(I)          | 0.0452(I)           | 0.0417(I)            | 0.0293(I)       | (C)<br>(D)<br>(D) |
|   |                              |                    |                     | <u>Rates</u>         |                 |                   |
| bulk-billed processing,<br>- per message    |                              |                    |                     | \$0.0191(I)          |                 | (C)<br>(D)<br>(D) |
| bulk-billed inquiry,<br>- per message       |                              |                    |                     | 0.0417 (I)           |                 | (C)<br>(D)<br>(D) |

PUBLIC SERVICE COMMISSION  
OF KENTUCKY  
EFFECTIVE

MAY 23 1995

PURSUANT TO 807 KAR 5:011,  
SECTION 9 (1)

BY: Jordan C. Neal  
FOR THE PUBLIC SERVICE COMMISSION

Issued: June 13, 1995

Effective: May 23, 1995

*Deborah A. Nisch*  
Vice President  
Integrated Corporate Planning for

President, Cincinnati, Ohio

ACCESS SERVICE TARIFF  
PSC No. 2

CINCINNATI BELL TELEPHONE COMPANY

1st Revised Page 431  
Cancels *Original* Page 431

8. Billing and Collection Services (Cont'd)

8.2 Billing Service (Cont'd)

8.2.1 Messane Billing Service (Cont'd)

(G) Rates and Charges (Cont'd)

|  | <u>Rates</u>   | (T) |
|--|----------------|-----|
| (8) Additional Bill Processing, per message above the bill capacity ordered and allowance specified,           |                |     |
| - message-billed processing, each  | \$ 0.0935      |     |
| - message-billed inquiry, each   | 0.0194         |     |
| - bulk-billed processing, each   | 0.0070         |     |
| - bulk-billed inquiry, each  | 0.0017         |     |
| (9) Message-Billed Service, in which one or more messages or message service related rate elements are billed, |                |     |
| - per bill rendered for an end user account  | <b>0.55(R)</b> |     |
| (10) Bulk-Billed Service, in which a charge associated with a bulk-billed service is billed,                   |                |     |
| - per bill rendered for an end user account  | <b>0.55(R)</b> |     |

PUBLIC SERVICE COMMISSION  
OF KENTUCKY  
EFFECTIVE

MAY 23 1995

PURSUANT TO 807 YAR 5.011,  
SECTION 9 (1)

BY: Jordan C. Neel  
FOR THE PUBLIC SERVICE COMMISSION

Issued: ~~June~~ 13, 1995

Effective: **May 23, 1995**

 Deborah A. Nisch, President, Cincinnati, Ohio  
Vice President  
Integrated Corporate Planning for



ACCESS SERVICE TARIFF  
PSCK No. 2

CINCINNATI BELL TELEPHONE COMPANY

1st Revised Page 432  
Cancels Original Page 432

8. Billinn and Collection Services (Cont'd)

8.2 Billing Service (Cont'd)

8.2.1 Message Billinn Service (Cont'd)

(G) Rates and Charnes (Cont'd)

|  | <b>Rates</b>                       | <b>(T)</b> |
|--|------------------------------------|------------|
| (11) End User Account Activity,<br>- Special Order Charge to receive end<br>user account data,   | ICB rates<br>and charges<br>apply. | <b>(T)</b> |
| - End User Account Establishment and<br>Change, except rate element rate level<br>changes and rates structure, Charge,<br>per end user account established or<br>changed, per recurring or nonrecurring<br>rate element established or changed and<br>end user balance due changed, each | \$ 2.44                            |            |
| - End User Account Rate Element Rate<br>Level Change Charge,<br>per rate element changed, each   | 2.44                               |            |
| - End User Account Rate Element Rate<br>Structure Change Charge,<br>per rate element changed, each   | ICB rates<br>and charges<br>apply. | <b>(T)</b> |

PUBLIC SERVICE COMMISSION  
OF KENTUCKY  
EFFECTIVE

MAY 23 1995

PURSUANT TO 807 KAR 5:011,  
SECTION 9(1)

BY: Jordan C. Neel  
FOR THE PUBLIC SERVICE COMMISSION

Issued: **June** 13, 1995

Effective: **May** 23, 1995

*Deborah A. Nisch*  
Vice President  
Integrated Corporate Planning for

President, Cincinnati, Ohio

ACCESS SERVICE TARIFF  
PSC No. 2

CINCINNATI BELL TELEPHONE COMPANY

1st Revised Page 433  
Cancels Original Page 433

8. Billing and Collection Services (Cont'd)

8.2 Billing Service (Cont'd)

8.2.1 Message Billing Service (Cont'd)

(G) Rates and Charges (Cont'd)

|   | <u>Rates</u>                 | (T)<br>(D) |
|---|------------------------------|------------|
| (12)  |                              |            |
| (13)  |                              |            |
| (14) Message Billing Service Special Order Charge,<br>- per Special Order   | \$10.51                      |            |
| (15) Retention of Records Under Accounting Orders,<br>- per order per month | ICB rates and charges apply. | (T)        |

PUBLIC SERVICE COMMISSION  
OF KENTUCKY  
EFFECTIVE

MAY 23 1995

PURSUANT TO 807 KAR 5.011,  
SECTION 9(1)

BY: *Jordan C. Neal*  
FOR THE PUBLIC SERVICE COMMISSION

Issued: June 13, 1995

Effective: May 23, 1995

*Deborah A. Neish*  
Vice President  
Integrated Corporate Planning for  
President, Cincinnati, Ohio

8. Billing and Collection Services (Cont'd)

8.2 Billing Service (Cont'd)

8.2.2

The material on this page and the following pages has been deleted and are reserved for future use.

1st Revised Page 434  
1st Revised Page 435  
1st Revised Page 436  
1st Revised Page 437  
1st Revised Page 438  
1st Revised Page 439  
1st Revised Page 440  
1st Revised Page 441  
1st Revised Page 442  
1st Revised Page 443  
1st Revised Page 444  
1st Revised Page 445  
1st Revised Page 446  
1st Revised Page 447  
1st Revised Page 448  
1st Revised Page 449  
1st Revised Page 450  
1st Revised Page 451  
1st Revised Page 452  
1st Revised Page 453

PUBLIC SERVICE COMMISSION  
OF KENTUCKY  
EFFECTIVE

MAY 23 1995

PURSUANT TO 807 KAR 5011,  
SECTION 9(1)

BY: Jordan C. Neal  
FOR THE PUBLIC SERVICE COMMISSION

Issued: **June 13, 1995**

Effective: **May 23, 1995**

*Deborah A. Nisch* President, Cincinnati, Ohio  
Vice President  
Integrated Corporate Planning for

ACCESS SERVICE TARIFF  
PSCK No. 2

CINCINNATI BELL TELEPHONE COMPANY

1st Revised Page 454  
Cancels *Original* Page 454

8. Billing and Collection Services (Cont'd)

8.2 Billing Service (Cont'd)

8.2.3 Purchase of Accounts Receivable

The Telephone Company will, unless the Telephone Company agrees to act as billing agent for the customer, purchase from the customer its accounts receivable that arise from bills rendered by the Telephone Company to that customer's end users. The purchase of accounts receivable will be limited to amounts due the customer when the Telephone Company provides Bill Rendering Service for that customer. After a customer orders Bill Rendering Service and the Telephone Company is purchasing the customer's accounts receivable, the customer is prohibited from assigning, transferring, selling, exchanging or giving these accounts receivable to any other entity or person. The customer will provide a written assurance to the Telephone Company as to such forbearance and any such assignment, transfer, sale, exchange or gift is null and void and will subject the customer to all liabilities, expenses, costs including attorney fees expended and incurred by the Telephone Company in pursuing exclusive ownership to the accounts receivable. (C) (C)

The Telephone Company's purchase of a customer's accounts receivable shall be with recourse adjustments as set forth in (B) following to account for amounts due the customer that the Telephone Company is unable to collect from the end users which use the customer's services. The amounts due the customer for the purchase of its accounts receivable will be determined as follows:

(A) Total Current Amount Billed

The Telephone Company for each end user bill day (i.e., the billing date on a bill for an end user of a customer's service) will determine from its records the total current amount lawfully billed to the customer's end users for customer services, including all taxes applicable to such services. Total Current Amount Billed will be determined for each customer for each end user bill day. PUBLIC SERVICE COMMISSION OF KENTUCKY EFFECTIVE

MAY 23 1995

PURSUANT TO 807 KAR 5:011,  
SECTION 9(1)

BY: Jordan C. Neel  
FOR THE PUBLIC SERVICE COMMISSION

Issued: June 13, 1995

Effective: May 23, 1995

Deborah A. Nisch President, Cincinnati, Ohio  
Vice President  
Integrated Corporate Planning for

8. Billinn and Collection Services (Cont'd)

8.2 Billinn Service (Cont'd)

8.2.3 Purchase of Accounts Receivable (Cont'd)

(B) Recourse Adjustments

For each bill day, the Telephone Company will make recourse adjustments to the Total Current Amount Billed as follows:

PUBLIC SERVICE COMMISSION,  
OF KENTUCKY  
EFFECTIVE

MAY 23 1995

PURSUANT TO 807 KAR 5.011,  
SECTION 9(1)

BY Janice A. Neal  
FOR THE PUBLIC SERVICE COMMISSION

(1) End User Adjustments

For each bill day, the Telephone Company will subtract from the Total Current Amount Billed the lawfully billed amounts which the Telephone Company removes from end users balances due in accordance with customer inquiry instructions. In addition, for each bill day, the Telephone Company will subtract from the Total Current Amount Billed, an amount that equals the face value of any customer gift certificates (or its predecessor company's gift certificates) the Telephone Company has in its possession. The customer gift certificates the Telephone Company possesses will be returned to the customer.

(2) Telephone Company and Customer Adjustments

For each bill day, the Telephone Company will subtract from the Total Current Amount Billed amounts for end user bills which the Telephone Company delivers to the customer and amounts for gross receipts taxes, if any, the Telephone Company is legally obligated to pay in connection with accounts purchased by and amounts billed and collected by the Telephone Company pursuant to 8.2.1 preceding. In addition, for each bill day, the Telephone Company may make adjustments to the Total Current Amount Billed to account for amounts on statements received from the customer for additions or subtractions to an end user balance due for services billed in prior periods. Also, each bill day, the Telephone Company may make adjustments to the Total Current Amount Billed to account for additions and subtractions for customer or Telephone Company prior billing period errors. (C)

Issued: June 13, 1995

Effective: May 23, 1995

*Deborah A. Nisch*

President, Cincinnati, Ohio

Vice President  
Integrated Corporate Planning for

ACCESS SERVICE TARIFF  
PSCK No. 2

CINCINNATI BELL TELEPHONE COMPANY

1st Revised Page 456  
Cancels Original Page 456

8. Billing and Collection Services (Cont'd)

8.2 Billing Service (Cont'd)

8.2.3 Purchase of Accounts Receivable (Cont'd)

(B) Recourse Adjustments (Cont'd)

(3) Uncollectible Adjustments

For each bill day, the Telephone Company will subtract from the Total Current Amount Billed an amount for uncollectibles. Uncollectibles are amounts billed by the Telephone Company to end users on Final Customer Bills that are added to the Uncollectible (realized) Accounts of the Telephone Company. The Telephone Company will determine the customer amount for uncollectibles for each bill day by multiplying the Total Current Amount Billed by the customer uncollectible factor rounded up to the nearest 1/1000th as determined in (a) or (b) following.

(a) To determine the customer uncollectible factor, except for the initial three months that Bill Rendering Services is provided to the customer, the (C)

PUBLIC SERVICE COMMISSION  
OF KENTUCKY  
EFFECTIVE

MAY 23 1995

PURSUANT TO 807 KAR 5011  
SECTION 9(1)

BY: Jordan C. Neal  
FOR THE PUBLIC SERVICE COMMISSION

Telephone Company will determine from its records the dollar amount lawfully billed on Final Customer Bills which, after standard collection efforts are completed, is added to its uncollectible (realized) accounts (uncollectible amount) for bills rendered to end users in the most recent 3 month period. This actual uncollectible amount will include (C) adjustments to account for any payments received by the Telephone Company for outstanding Final Customer Bill amounts that pre-date the most recent 3 month period and any deposits held by the Telephone Company for services provided to the end users where Final Customer Bills have been rendered. The uncollectible amount (including where necessary the customer's or its decessor company's history of uncollectible to develop a full recent 3 month period) will be used by

Issued: June 13, 1995

Effective: May 23, 1995

*Deborah A. Nisch*

Vice President  
Integrated Corporate Planning for

President, Cincinnati, Ohio

ACCESS SERVICE TARIFF  
PSCK No. 2

CINCINNATI BELL TELEPHONE COMPANY

1st Revised Page 457  
Cancels Original Page 457

8. Billing and Collection Services (Cont'd)

8.2 Billing Service (Cont'd)

8.2.3 Purchase of Accounts Receivable (Cont'd)

(B) Recourse Adjustments (Cont'd)

(3) Uncollectible Adjustments (Cont'd)

(a) (Cont'd)

the Telephone Company to determine the realized amount uncollectible for each customer which is provided Bill Rendering Service by the Telephone Company for the most recent 3 month period. This realized uncollectible amount for a customer will, after the adjustment to account for customer amounts for uncollectibles for the previous 3 month period which were greater or lesser than the realized uncollectible amount for the same 3 month period, be divided by the Total Current Amount Billed for the customer for the same most recent 3 month period to develop a customer uncollectible factor. This factor will be used by the Telephone Company for the next 3 months to determine the customer amount for uncollectibles. Just prior to the end of the 3 month period, the Telephone Company will determine a new customer uncollectible factor in the same manner as above for the ensuing 3 month period.

PUBLIC SERVICE COMMISSION  
OF KENTUCKY  
EFFECTIVE

MAY 23 1995

PURSUANT TO 807 KAR 5:011,  
SECTION 9 (1)

BY:  Gordon C. Neel   
FOR THE PUBLIC SERVICE COMMISSION

Issued: ~~June~~ 13, 1995

Effective: ~~May~~ 23, 1995

*Deborah A. Nisch*

President, Cincinnati, Ohio

Vice President  
Integrated Corporate Planning for

8. Billing and Collection Services (Cont'd)

8.2 Billing Service (Cont'd)

8.2.3 Purchase of Accounts Receivable (Cont'd)

(B) Recourse Adjustments (Cont'd)

(3) Uncollectible Adjustments (Cont'd)

(b) When a customer orders Bill Rendering Service, (C)  
the customer at the time such services are ordered shall provide to the Telephone Company a history of its or its predecessor company's uncollectibles. This history of uncollectibles shall indicate by month its total amounts billed and its uncollectible amounts. The Telephone Company will use these data to develop the customer uncollectible factor for the first three months. To the extent that such customer or its predecessor company data do not exist, then the customer uncollectible factor for the first three month period will be determined on an individual case basis. The customer uncollectible factor developed either from customer history or on an individual case basis will be used to determine the customer amount for uncollectibles for the first three month period.

PUBLIC SERVICE COMMISSION  
OF KENTUCKY  
EFFECTIVE

MAY 23 1995

PURSUANT TO 807 KAR 5:011.

SECTION 9 (1)

BY: Jordan C. Neal  
FOR THE PUBLIC SERVICE COMMISSION

(C) Payments of Net Purchase Amount to the Customer

(1) The Telephone Company will purchase accounts receivable from the customer on each end user bill day for an amount (purchase amount) which equals the Total Current Amount Billed as set forth in (A) preceding after known Adjustments as set forth in (B) preceding have been made. On the date (payment date) determined by adding 31 days to the end user bill day or on the next bill date (i.e., same date in the following month as the bill date), whichever is the shortest interval, except as provided herein, the Telephone Company will remit

PUBLIC SERVICE COMMISSION  
OF KENTUCKY  
EFFECTIVE

MAY 23 1995

PURSUANT TO 807 KAR 5:011.

SECTION 9 (1)

BY: Jordan C. Neal  
FOR THE PUBLIC SERVICE COMMISSION

Issued: June 13, 1995

Effective: May 23, 1995

*Deborah A. Nisch*

President, Cincinnati, Ohio

Vice President  
Integrated Corporate Planning for



ACCESS SERVICE TARIFF  
PSCK No. 2

CINCINNATI BELL TELEPHONE COMPANY

Original Page 459

8. Billing and Collection Services (Cont'd)

8.2 Billing Service (Cont'd)

8.2.3 Purchase of Accounts Receivable (Cont'd)

(C) Payments of Net Purchase Amount to the Customer (Cont'd)

(1) (Cont'd)

payment to the customer for the purchase amount less additional adjustments as set forth in (B)(1) and (B)(2) preceding (net purchase amount) received by the Telephone Company prior to the payment date. Payment will be made in immediately available funds. If such payment date would cause payment to be due on a Saturday, Sunday or Holiday (i.e., New Year's Day, Independence Day, Labor Day, Thanksgiving Day, Christmas Day, the Second Tuesday in November and a day when Washington's Birthday, Memorial Day or Columbus Day is legally observed), payment for the net purchase amount will be due to the customer as follows:

If such payment date falls on a Sunday or on a Holiday which is observed on a Monday, the payment date shall be the first non-Holiday day following such Sunday or Holiday. If such payment date falls on a Saturday or on a Holiday which is observed on Tuesday, Wednesday, Thursday or Friday, the payment date shall be the last non-Holiday day preceding such Saturday or Holiday.

- (2) Further, if any portion of the net purchase amount is not received by the customer by the payment date as set forth in (1) preceding, or if any portion of the net purchase amount is received by the customer in funds which are not immediately available to the customer, then a late payment penalty shall be due the customer. The late payment penalty shall be the portion of the net purchase amount not received by the payment date times a late factor. The late factor shall be the lesser of:

PUBLIC SERVICE COMMISSION  
OF KENTUCKY  
EFFECTIVE

MAR 3 1992

PURSUANT TO 807 KAR 5:011.

SECTION 9 (1)

Effective: March 3, 1992  
BY: *[Signature]*  
PUBLIC SERVICE COMMISSION MANAGER

Issued: February 7, 1992

*Robert E. Sigmon* for

President, Cincinnati, Ohio

Vice President - Regulatory Affairs

ACCESS SERVICE TARIFF  
PSCK No. 2

CINCINNATI BELL TELEPHONE COMPANY

1st Revised Page 460  
Cancels Original Page 460

8. Billinn and Collection Services (Cont'd)

8.2 Billinn Service (Cont'd)

8.2.3 Purchase of Accounts Receivable (Cont'd)

(c) Payments of Net Purchase Amount to the Customer (Cont'd)

(2) (Cont'd)

- (a) the highest interest rate (in decimal value) which may be levied by law for commercial transactions in the state in which the Telephone Company provides Bill Rendering Service to the customer, compounded daily for the number of days from the payment date to and including the date that the Telephone Company actually makes the payment to the customer, or (C)
- (b) 0.000370 per day, compounded daily for the number of days from the payment date to and including the date that the Telephone Company actually makes the payment to the customer. (C)

Any late payment penalty will be included with the next Telephone Company payment to the customer.

PUBLIC SERVICE COMMISSION  
OF KENTUCKY  
EFFECTIVE

MAY 23 1995

PURSUANT TO 807 KAR 5:011,  
SECTION 9 (1)

BY: Jordan C. Neal  
FOR THE PUBLIC SERVICE COMMISSION

Issued: June 13, 1995

Effective: **May 23, 1995**

*Deborah A. Nisch*

President, Cincinnati, Ohio

Vice President  
Integrated Corporate Planning for

ACCESS SERVICE TARIFF  
PSCK No. 2

CINCINNATI BELL TELEPHONE COMPANY

1st Revised Page 461  
Cancels Original Page 461

8. Billinn and Collection Services (Cont'd)

8.2 Billinn Service (Cont'd)

8.2.3 Purchase of Accounts Receivable (Cont'd)

(C) Payments of Net Purchase Amount to the Customer (Cont'd)

- (3) Also, if any adjustment that reduces an end user balance due is received by the Telephone Company from the customer after the date the Telephone Company billed the charges to be adjusted to the end user plus 45 days (billed plus date), then a late payment penalty shall be due the Telephone Company. The late payment penalty shall be the adjustment amount times a late factor. The late factor shall be the lessor of:
- (a) The highest interest rate (in decimal value) which may be levied by law for commercial transactions in the state in which the Telephone Company provides Bill Rendering Service to the customer, compounded daily for the number of days from the billed plus date to and including the date that the Telephone Company posts the end user account, or (C)
- (b) 0.000370 per day, compounded daily for the number of days from the billed plus date to and including the date that the Telephone Company posts the end user account. (C)

PUBLIC SERVICE COMMISSION  
OF KENTUCKY  
EFFECTIVE

MAY 23 1995

PURSUANT TO 807 KAR 5.011,  
SECTION 9 (1)

BY: Jordan C. Neal  
FOR THE PUBLIC SERVICE COMMISSION

Issued: June 13, 1995

Effective: May 23, 1995

 President, Cincinnati, Ohio

Vice President  
Integrated Corporate Planning for

8. Billing and Collection Services (Cont'd)

8.2 Billing Service (Cont'd)

8.2.3 Purchase of Accounts Receivable (Cont'd)

(C) Payments of Net Purchase Amount to the Customer (Cont'd)

(3) (Cont'd)

Any late payment penalty will be included with the adjustment made by the Telephone Company to the customer's Total Current Amount Billed.

(D) Netting of Customer Access Service Charges and Net Purchase Amounts

When a payment for customer Access Service Charges under this tariff is due to the Telephone Company from the customer on the same payment date that a net purchase amount is due to the customer from the Telephone Company, the Telephone Company may, with at least a 31 day notice to the customer, net the payment for customer Access Service Charges with the net purchase amount. The Telephone Company will pay the net amount to the customer on the payment date when such net amount is due the customer or require the customer to pay the Telephone Company the net amount when such net amount is due the Telephone Company. If either party does not make the payment on the payment date, a late payment penalty as set forth in (C) preceding or 2.4.1(B)(3) preceding, whichever is appropriate, applies.

Upon request from the customer, the Telephone Company will provide a copy of its methods and procedures used to determine the amounts named in this section (i.e., 8.2.3 Purchase of Accounts Receivable) to the authorized representative of the customer who is responsible for auditing these amounts.

PUBLIC SERVICE COMMISSION  
OF KENTUCKY  
EFFECTIVE

MAR 3 1992

PURSUANT TO 807 KAR 5:011,  
SECTION 9 (1)

BY:   
PUBLIC SERVICE COMMISSION MANAGER

Issued: February 7, 1992

Effective: March 3, 1992

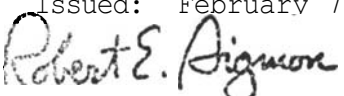
 for  
President, Cincinnati, Ohio

Vice President - Regulatory Affairs

ACCESS SERVICE TARIFF  
PSCK No. 2

CINCINNATI BELL TELEPHONE COMPANY

1st Revised Page 463  
Cancels Original Page 463

8. Billing and Collection Services (Cont'd)

8.2 Billinn Service (Cont'd)

8.2.4 Billing Arrangements when the Telephone Company Acts as Billing Agent for the Customer

When the Telephone Company agrees to act as billing agent for the customer, the billing service, payment arrangements and ownership of the accounts receivable will be as follows:

- (A) The billing services, including the collection from end users of monies for the customer accounts receivable that arise from bills rendered by the Telephone Company to that customer's end users, provided by the Telephone Company will be as set forth in 8.2.1 preceding. (C)
- (B) For the customer accounts receivable that arise from bills rendered by the Telephone Company to that customer's end users, the Total Current Amount Billed and the Recourse Adjustments will be determined as set forth in 8.2.3 preceding. The payment of the net monies due the customer will be handled as set forth in 8.2.3(C) preceding.
- (C) The ownership of the customer accounts receivable will not be transferred by the customer to the Telephone Company. When the customer discontinues Billing Service provided under this tariff where the Telephone Company is acting as billing agent for the customer, the Telephone Company will determine and make a final payment to the customer as set forth in (B) preceding. This final payment shall be considered to be all of the remaining monies due the customer for the bills rendered to the customer's end users by the Telephone Company. When the Telephone Company discontinues billing the customer's end users for customer services, any deposits for customer services will be returned to the appropriate end user in accordance with Telephone Company final billing procedures.

PUBLIC SERVICE COMMISSION  
OF KENTUCKY  
EFFECTIVE

MAY 23 1995

PURSUANT TO 807 KAR 5011,  
SECTION 9 (1)

BY: Jordan C. Neel  
FOR THE PUBLIC SERVICE COMMISSION

Issued: June 13, 1995

Effective: May 23, 1995

*Deborah A. Nisch* President, Cincinnati, Ohio

Vice President  
Integrated Corporate Planning for

8. Billing and Collection Services (Cont'd)

8.3 Billing Analysis Service

At the request of an IC, the Telephone Company upon reasonable notice and with reasonable effort will provide Billing Analysis Service for detection, investigation and deterrence of billing evasion activities.

The term "billing evasion activities" used herein denotes Message Billing Abuse and/or Network Abuse. Such abuse is the use of an access line (e.g., end user line or trunk, Pay Telephone line or other access line or trunk provided by the Telephone Company) where there is intent to circumvent or evade the proper charges in whole or in part for use of telecommunications services over the access line, or to conceal the points of origin or termination of telecommunications service.

Such activities include bypass or circumvention of Telephone Company billing equipment, unauthorized use of Telephone Company and IC service offerings, and unauthorized use of Telephone company facilities.

8.3.1 General Description

Billing Analysis Service is the provision of detection, investigation and deterrence of billing evasion activities.

Detection is the provision of equipment by the Telephone Company to identify and collect information on Network Abuse. Such equipment may be located in Telephone Company premises or offices or may be attached to access lines.

Investigation is the provision of investigative services to collect evidence to document that billing evasion activities are occurring, prepare reports, preserve evidence and supply expert witness analysis and testimony. Investigation also includes provision of services to coordinate the investigative activities between Exchange Telephone Companies and/or law enforcement agencies.

Deterrence is the contacting and interviewing of parties identified in billing evasion activities, the recovery of devices or materials used in billing evasion activities (where legally the service review for possible suspension of service over 'access lines identified in billing evasion activities and publicity assistance in publicizing billing evasion deterrence

PUBLIC SERVICE COMMISSION  
EFFECT  
MAR 3 1992

PURSUANT TO 807 KAR 5.011,  
SECTION 9 (1)

BY: Shaw-Della  
Effective: March 3, 1992

Issued: February 7, 1992

Robert E. Aigmon for

President, Cincinnati, Ohio

**Vice President - Regulatory Affairs**

ACCESS SERVICE TARIFF  
PSCK No. 2

CINCINNATI BELL TELEPHONE COMPANY

1st Revised Page 465  
Cancels Original Page 465

8. Billinn and Collection Services (Cont'd)

8.3 Billinn Analysis Service (Cont'd)

8.3.2 Undertaking of the Telephone Company

- (A) When Billing Analysis Service is ordered under a Special Order by an authorized Security representative of the IC, the Telephone Company will provide any one or all of the services as set forth in (B) through (D) following at rates and charges as set forth in 8.3.7 following.
- (B) Detection Service will be provided for Network Abuse at any central office switch equipped to recognize and record irregular key pulse and multi-frequency signals upon receipt of a Special Order from an IC specifying the central office(s) where detection service is requested. Subject to the agreement of the Telephone Company, special construction for the provision of central office equipment to recognize and record irregular key pulse and multifrequency signals may be undertaken at the request of the authorized Security representative of the IC to meet the needs of the IC. Such special construction will be provided at rates and charges based on estimated cost to be incurred.

PUBLIC SERVICE COMMISSION  
OF KENTUCKY

MAY 23 1995

PURSUANT TO 807 KAR 5:011,  
SECTION 9(1)

BY: Jordan C. Neel  
FOR THE PUBLIC SERVICE COMMISSION

Issued: June 13, 1995

Effective: **May 23, 1995**

*Deborah A. Nisch*

President, Cincinnati, Ohio

Vice President  
Integrated Corporate Planning for

ACCESS SERVICE TARIFF  
PSCK No. 2

CINCINNATI BELL TELEPHONE COMPANY

1st Revised Page 466  
Cancels Original Page 466

8. Billing and Collection Services (Cont'd)

8.3 Billinn Analysis Service (Cont'd)

8.3.2 Undertaking of the Telephone Company (Cont'd)

(B) (Cont'd)

- (2) The detection service reports as set forth in (1) preceding will include, for a signaling irregularity observed, the following: (a) the calling NPA and telephone number (i.e., NXX-XXXX), (b) the called number (i.e., NPA and telephone number recorded by Telephone Company billing equipment) if available, (c) signaling irregularity data, (d) the holding time of the call, if available, and (e) the date of the call, if available. The report will be provided as a paper printout or microfiche at the discretion of the Telephone Company and sent to the authorized Security representative of the IC via overnight service paid by the customer. However, an authorized Security representative of the IC may pick up the report at a location designated by the Telephone Company. The 60-day report will be available for mailing or pickup 2 weeks after the end of the 60-day period.

(C)  
(C)

(D)  
|  
(D)

PUBLIC SERVICE COMMISSION  
OF KENTUCKY  
EFFECTIVE

MAY 23 1995

PURSUANT TO 807 KAR 5:011,  
SECTION 9 (1)

BY: Jordan C. Neal  
FOR THE PUBLIC SERVICE COMMISSION

Issued: June 13, 1995

Effective: May 23, 1995

*Deborah A. Nesch*

President, Cincinnati, Ohio

Vice President  
Integrated Corporate Planning for



ACCESS SERVICE TARIFF  
PSCK No. 2

CINCINNATI BELL TELEPHONE COMPANY

1st Revised Page 467  
Cancels Original Page 467

8. Billing and Collection Services (Cont'd)

8.3 Billinn Analvsis Service (Cont'd)

8.3.2 Undertaking of the Teleohone Company (Cont'd)

- (C) Investigative Service will be provided by authorized Telephone Company Security personnel upon receipt of a Special Order from an authorized Security representative of the IC specifying the line or lines or billing evasion activity (i.e., Message Billing Abuse and/or Network Abuse) to be investigated. The services provided include the provision of an identification report, collection of evidence, provision of a detection, (C) preparation of an affidavit and prosecutive summary, (C) assistance to law enforcement agencies, provision of expert witness analysis and/or testimony, the coordination of billing evasion investigative services and the review of an IC's billing evasion control programs.
- (1) Provision of an identification report is the collection by Telephone Company personnel of billing information, party name, party address, service configuration, if any, and the preparation and submission of information pertinent to the IC's service in a report to the authorized Security representative of the IC for each line or billing evasion activity specified by the IC.
- (2) Collection of evidence is the gathering of information pertinent to the line, message, or party associated with the billing evasion activity specified by the authorized Security representative of the IC. Collection of evidence includes a written notification to the authorized Security representative of the IC of the results of such gathering efforts. The Telephone Company will determine the information provided in the written notification.

PUBLIC SERVICE COMMISSION  
OF KENTUCKY  
EFFECTIVE

MAY 23 1995

PURSUANT TO 807 KAR 5.011,  
SECTION 9(1)

BY: Jordan C. Neel  
FOR THE PUBLIC SERVICE COMMISSION

Issued: June 13, 1995

Effective: May 23, 1995

*Deborah A. Nisch*

President, Cincinnati, Ohio

Vice President  
Integrated Corporate Planning for

ACCESS SERVICE TARIFF  
PSCK No. 2

CINCINNATI BELL TELEPHONE COMPANY

1st Revised Page 468  
Cancels Original Page 468

8. Billinn and Collection Services (Cont'd)

8.3 Billinn Analysis Service (Cont'd)

8.3.2 Undertaking of the Telephone Company (Cont'd)

(C) (Cont'd)

(3)

(D)

(D)

- (4) Preparation of an affidavit and prosecutive summary is the written documentation of the evidence collected by the Telephone Company personnel who performed such activities.

PUBLIC SERVICE COMMISSION  
OF KENTUCKY  
EFFECTIVE

MAY 23 1995

PURSUANT TO 807 KAR 5-011,  
SECTION 9(1)

BY: Jordan C. Neel  
FOR THE PUBLIC SERVICE COMMISSION

Issued: June 13, 1995

Effective: May 23, 1995

*Deborah A. Nisch*

President, Cincinnati, Ohio

Vice President  
Integrated Corporate Planning for

ACCESS SERVICE TARIFF  
PSCK No. 2

CINCINNATI BELL TELEPHONE COMPANY

1st Revised Page 469  
Cancels Original Page 469

8. Billing and Collection Services (Cont'd)

8.3 Billing Analysis Service (Cont'd)

8.3.2 Undertaking of the Telephone Company (Cont'd)

(C) (Cont'd)

(5)

PUBLIC SERVICE COMMISSION  
OF KENTUCKY  
EFFECTIVE

MAY 23 1995

PURSUANT TO 807 KAR 5.011,  
SECTION 9(1)

BY: Jordan C. Neel  
FOR THE PUBLIC SERVICE COMMISSION

(D)

(D)

- (6) Assistance to law enforcement is the accompanying of duly authorized law enforcement personnel to a location where billing evasion activities have been determined to exist in order to identify billing evasion activity devices or materials. The Telephone Company personnel will provide such assistance to law enforcement personnel only after law enforcement involvement has been arranged by the IC, or under services as set forth in (10) following. If such assistance is required at locations outside the operating territory of the Telephone Company involved, any out of pocket payments for travel and/or other expenses of Telephone Company personnel will be billed to the IC, except to the extent that such expenses are paid by the judicial system.
- (7) Provision of expert witness analysis is the review, study and other technical support activities provided by Telephone Company experts to analyze and/or document whether devices and materials associated with an investigation furnished by the authorized Security representative of the IC or under services as set forth in (10) following operate, perform or contain billing evasion activities. A written analysis report will be provided to the authorized Security representative of the IC. The expert will be selected by the Telephone Company.

Issued: June 13, 1995

Effective: **May 23, 1995**



President, Cincinnati, Ohio

Vice President  
Integrated Corporate Planning for

ACCESS SERVICE TARIFF  
PSC No. 2

CINCINNATI BELL TELEPHONE COMPANY

Original Page 470

8. Billing and Collection Services (Cont'd)

8.3 Billing Analysis Service (Cont'd)

8.3.2 Undertaking of the Telephone Company (Cont'd)

(C) (Cont'd)

- (8) Provision of expert witness testimony is the preparation of testimony and the submission of such testimony in association with an investigation. A copy of the written testimony, if any, will be provided to the authorized Security representative of the IC. The expert witness will be selected by the Telephone Company. Any out of pocket payments for travel and/or other expenses of Telephone Company personnel will be billed to the IC.
- (9) Coordination of billing evasion investigative services between telephone companies is the referral of investigative information to other telephone company Security personnel, provision of billing evasion information to other telephone company Security personnel, the collection of information from other telephone company Security personnel, and the tracking, collecting and reporting of the results of such investigations to the authorized Security representative of the IC.
- (10) Coordination of billing evasion investigative activities of participating law enforcement agencies is the provision of billing evasion information to the law enforcement agencies, the collection of billing evasion information from the law enforcement agencies and the tracking, collecting and reporting of the results of such participation to the authorized Security representative of the IC. This coordination will be provided only upon receipt of written authorization from the authorized Security representative of the IC.
- (11) Review of the IC billing evasion deterrence control programs and related activities is advice to and/or training of IC personnel on billing evasion deterrence and preventive controls and the development of billing evasion deterrence and preventive control programs for the IC.

PUBLIC SERVICE COMMISSION  
OF KENTUCKY  
EFFECTIVE

MAR 3 1992

PURSUANT TO 807 KAR 5:011,

Effective: SECTION 9(1)  
March 3, 1992

BY: *Sharon Helle*  
PUBLIC SERVICE COMMISSION MANAGER

Issued: February 7, 1992

*Robert E. Dignon* for

President, Cincinnati, Ohio

Vice President - Regulatory Affairs

8. Billing and Collection Services (Cont'd)

8.3 Billing Analysis Service (Cont'd)

8.3.2 Undertaking of the Telephone Company (Cont'd)

(C) (Cont'd)

The Telephone Company will, at the request of the IC, provide investigation service on a premium time basis. When investigation service is provided on such a basis, premium time charges as set forth in 8.3.7(B) following apply.

(D) Deterrence services will be provided at any location in the operating territory of the Telephone Company that Telephone Company Security personnel can safely and legally enter. Deterrence services will be provided, at the request of the authorized Security representative of the IC, by written or telephonic notice. A telephone notice received from the authorized Security representative of the IC, must be followed by written confirmation within one day. Deterrence services will be provided only after an investigation service has been provided by the Telephone Company and billing evasion activity is found to warrant such actions. Deterrence service includes the contracting and interviewing of parties identified by the Telephone Company as being involved in billing evasion activities, the recovery of devices and/or materials associated with billing evasion activities, service review for possible suspension of Telephone Company service, and publicity assistance for publicizing billing evasion activity deterrence.

(1) Contacting and interviewing of parties is the written or verbal notification to, or a face-to-face discussion with, a party or parties by Telephone Company Security personnel in order to deter further billing evasion activities. Contacting and interviewing is provided at locations identified by law enforcement agencies, the IC or the Telephone Company.

(2) Recovery of devices or materials is the attempt by Telephone Company Security personnel to recover devices or materials which are used in association with Telephone Company facilities in billing evasion activities. Such recovery is provided at locations identified by the Telephone Company, law enforcement agencies or the IC.

MAR 3 1992

PURSUANT TO 807 KAR 5:011,

SECTION 9 (1)

Effective: March 3, 1992

BY: *[Signature]*  
PUBLIC SERVICE COMMISSION MANAGER

Issued: February 7, 1992

*Robert E. Aigmon* for

President, Cincinnati, Ohio

Vice President - Regulatory Affairs

8. Billing and Collection Services (Cont'd)

8.3 Billing Analysis Service (Cont'd)

8.3.2 Undertaking of the Telephone Company (Cont'd)

(D) (Cont'd)

(3) Service Review for possible suspension of Telephone Company service is the request for authority to suspend service from appropriate Telephone Company officers, notification to the end user that service will be suspended and, after review of the end user response, or lack thereof, suspension of service, if warranted, in the Telephone Company's judgement.

(4) Publicity assistance for publicizing billing evasion activity deterrence is the provision of information and personnel to aid in publicizing billing evasion activity deterrence. The Telephone Company will determine what information it will provide, if any, and will select the personnel and media, if any, to provide this service.

8.3.3 Liability of the Telephone Company

Notwithstanding 2.1.3 preceding, in the absence of willful misconduct, no liability for damages to the IC or other person or entity shall attach to the Telephone Company for its action or the conduct of its employees in providing Billing Analysis Service.

8.3.4 Obligations of the IC

(A) The authorized Security representative of the IC shall order all Billing Analysis Service under a Special Order. The authorized Security representative of the IC shall order those Billing Analysis Services it wishes to receive.

(B) With each other, the IC shall designate and identify its authorized Security representative who will be responsible to protect the information and to whom the Billing Analysis Service information will be provided. The IC shall assure and take every effort to make sure the Billing Analysis Service information is provided to and used only by authorized personnel involved in billing evasion activity.

PURSUANT TO \$07 KAR 5:011,  
SECTION 9(1)

Issued: February 7, 1992

Effective: *March 3, 1992*  
PUBLIC SERVICE COMMISSION MANAGER

*Robert E. Aigmon* for President, Cincinnati, Ohio

Vice President - Regulatory Affairs

ACCESS SERVICE TARIFF  
PSCK No. 2

CINCINNATI BELL TELEPHONE COMPANY

1st Revised Page 473  
Cancels Original Page 473

8. Billing and Collection Services (Cont'd)

8.3 Billing Analysis Service (Cont'd)

8.3.4 Oblinations of the IC (Cont'd)

(C) When Billing Analysis Service Investigation is ordered, the authorized Security representative of the IC shall furnish all known details of the billing evasion activities, including the access lines, parties or messages to be investigated, and shall furnish all necessary end user information it possesses to the Telephone Company Security personnel. The specification of the access line, party or message to be investigated shall be in writing by the authorized Security representative of the IC.

(D) When law enforcement agencies are to be brought into the investigation, the authorized Security representative of the IC shall secure their participation or authorize the Telephone Company in writing to obtain and coordinate such law enforcement agency participation.

(E)

(D)

(F) When the IC requests that service be suspended for unauthorized use, the IC shall furnish a written request authorized by an officer of the IC. The request shall state the reason for the request and tariff, contract or legal provision permitting such suspension and shall correctly identify the end user telephone number and the location of the end user service to be suspended.

(D)

(G) All inquiries from the IC's end users concerning services provided under this tariff are to be handled by the IC. Any questions to the Telephone Company shall be made by the authorized Security representative of the IC.

PUBLIC SERVICE COMMISSION  
OF KENTUCKY  
EFFECTIVE

MAY 23 1995

PURSUANT TO 807 KAR 5.011,  
SECTION 9(1)

BY: Jordan C. Neal  
FOR THE PUBLIC SERVICE COMMISSION

Issued: June 13, 1995

Effective: May 23, 1995

*Deborah A. Nisch* President, Cincinnati, Ohio  
Vice President  
Integrated Corporate Planning for

ACCESS SERVICE TARIFF  
PSCK No. 2

CINCINNATI BELL TELEPHONE COMPANY

1st Revised Page 474  
Cancels Original Page 474

8. Billing and Collection Services (Cont'd)

8.3 Billing Analysis Service (Cont'd)

8.3.4 Obligations of the IC (Cont'd)

- (H) Except as set forth in 8.3.2(D)(4) preceding, publicizing of actions resulting from services provided under this tariff shall be the responsibility of the IC. The IC shall not publicize that the Telephone Company assisted the IC unless the IC has written permission to do so from the Telephone Company.

PUBLIC SERVICE COMMISSION  
OF KENTUCKY  
EFFECTIVE (I)

MAY 23 1995

PURSUANT TO 807 KAR 5:011  
SECTION 9(1)

BY: [Signature]  
FOR THE PUBLIC SERVICE COMMISSION

(D)  
When provision of expert witness analysis is ordered by the IC, the IC shall be responsible for furnishing the evidence to be analyzed unless the services as set forth in 8.3.2(C)(10) preceding are ordered by the IC.

- (K) When provision of expert witness testimony is ordered by the IC, the IC shall include the name, if any, of the Telephone Company expert it desires and when and where the testimony is needed.

- (L) (Reserved)

8.3.5 Payment Arrangements

(A) Minimum Periods

The minimum period for which Billing Analysis detection service continuous scanning is provided and for which charges apply is one week.

(B) Cancellation of a Special Order

An IC may cancel a Special Order for Billing Analysis Service on any date prior to the service date. The cancellation date is the date the Telephone Company receives written or verbal

Issued: June 13, 1995

Effective: May 23, 1995

[Signature] President, Cincinnati, Ohio  
Vice President  
Integrated Corporate Planning for



ACCESS SERVICE TARIFF  
PSCK No. 2

CINCINNATI B E U TELEPHONE COMPANY

1st Revised Page 475  
Cancels Original Page 475

8. Billing and Collection Services (Cont'd)

8.3 Billing Analysis Service (Cont'd)

8.3.5 Payment Arrangements (Cont'd)

(B) Cancellation of a Special Order (Cont'd)

notice from the authorized Security representative of the IC that the Special Order is to be cancelled. The verbal notice must be followed by written confirmation within 10 days. The service date for Billing Analysis Service is the date the Telephone Company Security organization receives the Special Order.

When an IC cancels a Special Order for Billing Analysis Service after the order date but prior to the start of service, a charge as listed following shall apply.

- (1) For detection service, the per report charge for each 60-day report ordered. (C)
- (2) For investigative service, two times the appropriate hourly charge for the service ordered. (C)
- (3) For deterrence service, two times the contact and interview of parties hourly charge for the service ordered.

PUBLIC SERVICE COMMISSION  
OF KENTUCKY  
EFFECTIVE

MAY 23 1995

PURSUANT TO 807 KAR 5:011,  
SECTION 9(1)

BY: Jordan C. Neel  
FOR THE PUBLIC SERVICE COMMISSION

(C) Changes to Special Orders

IC requested changes to a pending Special Order for Billing Analysis Service will be undertaken if they can be accommodated by the Telephone Company. However, all changes to pending Special Orders for detection service will be considered as a discontinuance of the pending order and the placement of a new order and appropriate charges will apply. Any additional time required on the part of the Telephone Company personnel will be billed to the IC at the appropriate hourly charges.

8.3.6 Rate Regulations

- (A) The charge per report for the 60 day report, as set forth in 8.3.7(A) following, applies for each report provided to an IC even though no signaling irregularities are found.

Issued: **June 13, 1995**

Effective: **May 23, 1995**



President, Cincinnati, Ohio

Vice President  
Integrated Corporate Planning for

ACCESS SERVICE TARIFF  
PSCK No. 2

CINCINNATI BELL TELEPHONE COMPANY

1st Revised Page 476  
Cancels Original Page 476

8. Billing and Collection Services (Cont'd)

8.3 Billing Analysis Service (Cont'd)

8.3.6 Rate Regulations (Cont'd)

(B)

(D)

(D)

- (C) The per hour rate for investigative service and/or deterrence service is for the use of one hour of Telephone Company Security person's time.
- (D) The Telephone Company will keep a count of the hours and fraction thereof used by Telephone Company personnel to provide the service the IC ordered and will bill the IC in accordance with these records. The hours for each service ordered will be summed and then rounded to the nearest hour, except that when the total time is less than one hour, one hour will be used to determine charges.
- (E) Premium time is all hours for work performed outside the Telephone Company's normal work schedule and/or which requires additions to the work force.
- (F) The Provision of Billing Analysis Service per Special Order charge applies for each Special Order accepted by the Telephone Company for any Billing Analysis Service.

PUBLIC SERVICE COMMISSION  
OF KENTUCKY  
EFFECTIVE

MAY 23 1995

PURSUANT TO 807 KAR 5:011,  
SECTION 9(1)

BY: Jordan C. Neel  
FOR THE PUBLIC SERVICE COMMISSION

Issued: June 13, 1995

Effective: May 23, 1995

*Deborah A. Nisch*  
Vice President  
Integrated Corporate Planning for

President, Cincinnati, Ohio

ACCESS SERVICE TARIFF  
PSCK No. 2

CINCINNATI BELL TELEPHONE COMPANY

1st Revised Page 477  
Cancels Original Page 477

8. Billing and Collection Services (Cont'd)

8.3 Billing Analysis Service (Cont'd)

8.3.7 Rate and Charges

The rates are:

|  | <u>Rates</u> | (T)               |
|--|--------------|-------------------|
| (A) Detection Service,<br>- 60 Day Report per office, per report | \$75.00(I)   | (T)<br>(D)<br>(D) |
| (B) Investigative Service,<br>- Identification Report, per hour  | 75.00*(I)    | (T)               |
| - Collection of Evidence, per hour                               | 75.00*(I)    | (T)<br>(D)<br>(D) |
| - Preparation of Affidavit and<br>Prosecutive Summary, per hour  | 75.00*(I)    | (T)<br>(D)        |
| - Assist Law Enforcement, per hour                               | 75.00*(I)    | (T)               |
| - Provision of Expert Witness Analysis,<br>per hour              | 75.00*(I)    | (T)               |
| - Provision of Expert Witness Testimony,<br>per hour             | 75.00*(I)    | (T)               |
| - Coordination services, per hour                                | 75.00*(I)    |                   |
| - Review services, per hour                                      | 75.00*(I)    | (T)               |
| (C) Deterrence Service,<br>- Recovery of devices, per hour       | 75.00(I)     | (T)               |
| - Contact and Interview of Parties,<br>Per hour                  | 75.00(I)     | (T)               |
| - Service Review, per hour                                       | 75.00(I)     |                   |
| - Publicity Assistance, per hour                                 | 75.00(I)     | (T)               |
| (D) Provision of Billing Analysis Service,<br>-per Special Order |              | (T)               |

PUBLIC SERVICE COMMISSION  
OF KENTUCKY  
EFFECTIVE  
10.51

MAY 23 1995

PURSUANT TO 807 KAR 5011,  
SECTION 9 (1)

BY: Jordan C. Neal  
FOR THE PUBLIC SERVICE COMMISSION

\* Premium time per hour rates are two times the per hour rates.

Issued: June 13, 1995

Effective: **May 23, 1995**

  
Deborah A. Nisch, President, Cincinnati, Ohio  
Vice President  
Integrated Corporate Planning for

ACCESS SERVICE TARIFF  
PSCK No. 2

CINCINNATI B E U TELEPHONE COMPANY

1st Revised Page 478  
Cancels Original Page 478

8. Billinn and Collection Services (Cont'd)

8.4 Billinn Information Service

At the request of the customer, the Telephone Company will provide information to the customer from its end user records, billing files and account data base.

8.4.1 General Description

Billing Information Service is the provision of information to the customer from Telephone Company record systems labeled as Customer Records Information System (CRIS), and Customer Name and Address Bureau (CNA). Such Billing Information Service will be limited to the provision of information to a customer relating exclusively to end user services provided by that customer. Information relating to services provided by any other entity will not be provided. (D)

Information is defined as any entry in the records or bureau listings which is not listed as proprietary to the Telephone Company. Any entry listed as proprietary to the Telephone Company will not be provided. (D)

8.4.2 Undertaking of the Telephone Company

(A) When Billing Information Service is ordered by the customer, the Telephone Company will provide information on a request by request basis as follows in (B) through (M) following at the rates and charges as set forth in 8.4.7 following.

(B) Upon request from a customer and when the customer has ordered Message Billing Service Bill Rendering Service, the Telephone Company will provide information from its CRIS records as follows: (T)

- (1)
- (2) account detail for a message end user
- (3) service detail for a message end user.

PUBLIC SERVICE COMMISSION  
OF KENTUCKY  
EFFECTIVE

MAY 23 1995

PURSUANT TO 807 KAR 5.011,  
SECTION 9 (1)  
BY: Jordan C. Neel  
FOR THE PUBLIC SERVICE COMMISSION

Issued: June 13, 1995

Effective: May 23, 1995

*Deborah A. Nisch*  
Vice President  
Integrated Corporate Planning for  
resident, Cincinnati, Ohio

ACCESS SERVICE TARIFF  
PSC No. 2

CINCINNATI BELL TELEPHONE COMPANY

1st Revised Page 479  
Cancels Original Page 479

8. Billing and Collection Services (Cont'd)

8.4 Billing Information Service (Cont'd)

8.4.2 Undertaking of the Telephone Company (Cont'd)

(B) (Cont'd)

Account detail is data that furnishes the end user name,  
billing address and billing parameters other than service  
detail. (C)  
(C)

Service detail is data associated with the customer's rate  
elements. (C)

A message end user is an account with customer message or  
bulk-billed detail (for a bill period), as set forth in (C)  
(F) following, or established as an end user of the  
customer's message or bulk-billed services.

Account detail and/or service detail which is confidential (C)  
due to legal, national security, end user or other appro-  
priate requirements will not be provided. If the customer  
requires this information in order to bill its services, it  
shall secure written permission from the end user to obtain  
the information from the Telephone Company. The customer  
shall furnish the Telephone Company the end user's written  
permission for the information to be released.

PUBLIC SERVICE COMMISSION  
OF KENTUCKY  
EFFECTIVE

MAY 23 1995

PURSUANT TO 807 KAR 5:011,  
SECTION 9(1)

BY: Jordan C. Neal  
FOR THE PUBLIC SERVICE COMMISSION

Issued: June 13, 1995

Effective: May 23, 1995

 President, Cincinnati, Ohio  
Vice President  
Integrated Corporate Planning for

ACCESS SERVICE TARIFF  
PSC No. 2

CINCINNATI BELL TELEPHONE COMPANY

1st Revised Page 480  
Cancels Original Page 480

8. Billinn and Collection Services (Cont'd)

8.4 Billinn Information Service (Cont'd)

8.4.2 Undertakinn of the Telephone Company (Cont'd)

(C)

(D)

(D)

PUBLIC SERVICE COMMISSION  
OF KENTUCKY  
EFFECTIVE

MAY 23 1995

PURSUANT TO 807 KAR 5:011,  
SECTION 9 (1)

BY: Jordan C. Neal  
FOR THE PUBLIC SERVICE COMMISSION

Issued: June 13, 1995

Effective: May 23, 1995

*Deborah A. Nisch*  
Vice President  
Integrated Corporate Planning for

President, Cincinnati, Ohio

ACCESS SERVICE TARIFF  
PSCK No. 2

CINCINNATI BELL TELEPHONE COMPANY

1st Revised Page 481  
Cancels Original Page 481

8. Billinn and Collection Services (Cont'd)

8.4 Billinn Information Service (Cont'd)

8.4.2 Undertakinn of the Telephone Company (Cont'd)

(D)

(D)

(E)

PUBLIC SERVICE COMMISSION  
OF KENTUCKY  
EFFECTIVE

MAY 23 1995

PURSUANT TO 807 KAR 5:011,  
SECTION 9(1)

BY: Jordan C. Neal  
FOR THE PUBLIC SERVICE

(D)

Issued: **June 13, 1995**

Effective: **May 23, 1995**

*Deborah A. Nisch*

President, Cincinnati, Ohio

Vice President

Integrated Corporate Planning for

ACCESS SERVICE TARIFF  
PSCK No. 2

CINCINNATI BELL TELEPHONE COMPANY

1st Revised Page 482  
Cancels Original Page 482

8. Billinn and Collection Services (Cont'd)

8.4 Billinn Information Service (Cont'd)

8.4.2 Undertaking of the Telephone Company (Cont'd)

(P) CRIS information will be provided on a total file and/or file update basis as follows: (D)

(1) The total file basis will permit the customer to receive, at the customer's option, all the end user information that is authorized for the customer's use on paper printout, magnetic) tape or fiche. The total file output will contain end user information for the current billing period. The billing period will be set by the Telephone Company. The magnetic tapes will be provided without the return of previously supplied tapes. The Telephone Company will supply the magnetic tapes. After the information system ordered by the customer is in service, the paper printout, magnetic tape) or fiche will be available from the Telephone Company within 10 working days of the IC request.

PUBLIC SERVICE COMMISSION  
OF KENTUCKY  
EFFECTIVE

MAY 23 1995

PURSUANT TO 807 KAR 5:011,  
SECTION 9 (1)

BY: Jordan C. Neel  
FOR THE PUBLIC SERVICE COMMISSION

Program development charges as set forth in 8.4.7 following, apply for the hours required to design, develop, test and maintain the necessary programs that were used to provide the paper output, magnetic tape or fiche.

Once available, the paper printout, magnetic tape or fiche will be sent to the customer via overnight service paid by the customer. At the option of the customer, the customer may pick up the paper printout, magnetic tape or fiche at a location designated by the Telephone Company or request the information be data-transmitted to the customer. When the information is data-transmitted to the customer, the data transmission charges will be determined as set forth in 8.4.7(F) following. (C)  
(C)

(2) The file update basis will permit the customer to receive, at the customer option, all the end user information that is authorized for the customer's use on paper printout, fiche or magnetic tape. The file update output will contain end user information for the current billing period only. The current billing period is the period associated with the most recent bill rendered to an end user. The magnetic

Issued: June 13, 1995

Effective: May 23, 1995

*Deborah A. Neish*

President, Cincinnati, Ohio

Vice President  
Integrated Corporate Planning for



ACCESS SERVICE TARIFF  
PSCK No. 2

CINCINNATI BELL TELEPHONE COMPANY

1st Revised Page 483  
Cancels **Original** Page 483

8. Billinn and Collection Services (Cont'd)

8.4 Billing Information Service (Cont'd)

8.4.2 Undertaking of the Telephone Company (Cont'd)

(P) (Cont'd)

(2) (Cont'd)

tapes will be provided without the return of previously supplied tapes. The Telephone Company will supply magnetic tapes. The file updates will include those records added and those records deleted, if any (deleted records may not be retained by all of the Telephone Companies). For CRIS information, the file updates will be provided on a monthly interval.

(D)  
(D)

Program development charges as set forth in 8.4.7 following, apply for the hours required to design, develop, test and maintain the necessary programs that are used to provide the paper output, fiche or magnetic tape.

PUBLIC SERVICE COMMISSION  
OF KENTUCKY  
EFFECTIVE

MAY 23 1995

PURSUANT TO 807 KAR 5:011,  
SECTION 9(1)

BY: Jordan C. Neal  
FOR THE PUBLIC SERVICE COMMISSION

Issued: June 13, 1995

Effective: **May 23, 1995**

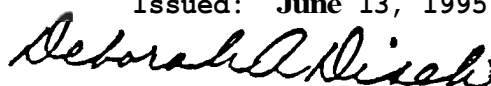
  
Deborah A. Nisch, President, Cincinnati, Ohio  
Vice President  
Integrated Corporate Planning for

ACCESS SERVICE TARIFF  
PSCK No. 2

CINCINNATI BELL TELEPHONE COMPANY

1st Revised Page 484  
Cancels Original Page 484

8. Billing and Collection Services (Cont'd)

8.4 Billing Information Service (Cont'd)

8.4.2 Undertakinn of the Telephone Company (Cont'd)

(F) (Cont'd)

(2) (Cont'd)

Once available, the file update paper printout, fiche or magnetic tape will be sent to the customer via overnight service paid by the customer. At the option (C) of the customer, the customer may pick up the paper output, fiche or magnetic tape at a location designated by the Telephone Company or request the information be data-transmitted to the customer. When the information is data-transmitted to the customer, the data transmission charges will be determined as set forth in 8.4.7(F). (C)

- (3) The total file output and the file update output will, at the option of the customer, be provided on a quick turnaround basis. Such quick turnaround output will be provided one working day after the information that the customer ordered is available. Once available, the output will be provided on paper printout, fiche, or magnetic tape and will be sent to the customer via overnight service paid by the customer. At the option (C) of the customer, the customer may pick up the paper output, fiche or magnetic tape at a location designated by the Telephone Company or request the information be data-transmitted to the customer. When the information is data-transmitted to the customer, the data transmission charges will be determined as set forth in 8.4.7(F). (C)

PUBLIC SERVICE COMMISSION  
OF KENTUCKY  
EFFECTIVE

MAY 23 1995

PURSUANT TO 807 KAR 5.011,  
SECTION 9(1)

BY: Jordan C. Neel  
FOR THE PUBLIC SERVICE COMMISSION

Issued: June 13, 1995

Effective: May 23, 1995

*Deborah A. Nisch*

President, Cincinnati, Ohio

Vice President

Integrated Corporate Planning for

ACCESS SERVICE TARIFF  
PSCK No. 2

CINCINNATI BELL TELEPHONE COMPANY

1st Revised Page 485  
Cancels Original Page 485

8. Billing and Collection Services (Cont'd)

8.4 Billing Information Service (Cont'd)

8.4.2 Undertakinn of the Telephone Company (Cont'd)

(G)

(D)

(D)

(H) Upon acceptance by the Telephone Company of a Special Order for Billing Information Service from a customer the Telephone Company will determine the period of time to implement such service on an individual order basis.

(I)

(D)

(D)

(J) Upon request from an authorized supervisor of the customer who furnishes the account code assigned by the Telephone Company, the Telephone Company will provide name and town information from its CNA bureau. The CNA name and town data, but not street address will be provided only when the customer needs the information to authorize a call, to bill a call, or to handle an emergency situation. The information will be provided on a request by request basis by voice telecommunications. Name town and state will be provided for a telephone number. A request includes the handling of one call and providing the data for one telephone number.

PUBLIC SERVICE COMMISSION,  
OF KENTUCKY  
EFFECTIVE

MAY 23 1995

PURSUANT TO 807 KAR 5:011,  
SECTION 9 (1)

BY: *Jordan C. Neel*

Issued: June 13, 1995

Effective: May 23, 1995

*Deborah A. Nisch*

President, Cincinnati, Ohio

Vice President  
Integrated Corporate Planning for

ACCESS SERVICE TARIFF  
PSCK No. 2

CINCINNATI BELL TELEPHONE COMPANY

1st Revised Page 486  
Cancels Original Page 486

8. Billing and Collection Services (Cont'd)

8.4 Billing Information Service (Cont'd)

8.4.2 Undertaking of the Telephone Company (Cont'd)

(J) (Cont'd)

The Telephone Company will specify the location where requests are to be received and the format in which the request is to be made.

PUBLIC SERVICE COMMISSION  
OF KENTUCKY  
EFFECTIVE

If the name and address associated with the telephone number is restricted due to the request of the end user, legal authority or law enforcement agency, no name or town location will be provided.

MAY 23 1995

PURSUANT TO 807 KAR 5011,  
SECTION 9(1)

At the request of the customer, written confirmation of the name and town location will be sent to the authorized supervisor making the request by overnight service paid by the customer. (C)

BY: Jordan C. Nish  
FOR THE PUBLIC SERVICE COMMISSION

(K) If the customer requests the information ordered by the customer be resupplied by the Telephone Company because of incorrect customer specifications or errors, the Telephone Company will resupply the information in accordance with a new customer order and all appropriate charges as set forth in 8.4.7 following will apply.

(L)

(D)  
|  
(D)

(M) The Telephone Company will provide Billing Information Service under a Special Order. For all Billing Information Services, the Billing Information Service Special Order charge as set forth in 8.4.7(I) following applies.

8.4.3 Liability of the Telephone Company

Notwithstanding 2.1.3 preceding, in the absence of willful misconduct, no liability for damages to the customer or other person or entity shall attach to the Telephone Company for its action or the conduct of its employees in providing Billing Information Service.

Issued: June 13, 1995

Effective: May 23, 1995

*Deborah A. Nish*  
Vice President  
Integrated Corporate Planning for

President, Cincinnati, Ohio

ACCESS SERVICE TARIFF  
PSCK No. 2

CINCINNATI BELL TELEPHONE COMPANY

1st Revised Page 487  
Cancels Original Page 487

8. Billing and Collection Services (Cont'd)

8.4 Billing Information Service (Cont'd)

8.4.4 Obligations of the Customer

(A) The customer shall order Billing Information Service under a Special Order. The customer shall order those Billing Information Services for the states where it wishes to receive the services and shall specify how often it wishes the service to be provided.

(B) With each order, the customer shall identify the authorized individual and address to receive the Billing Information Service output.

When CNA service is ordered, the customer will identify in writing and include the account codes assigned by the Telephone Company of all authorized individuals who will contact the CNA bureau.

(C) The customer shall take every effort to make sure that Billing Information Service output is provided only to authorized personnel. The customer shall agree, in writing to the Telephone Company, that the customer will not provide the Billing Information Service outputs to third parties for any use by such third parties except for work for the customer and which is under complete control of the customer.

(D)

PUBLIC SERVICE COMMISSION  
OF KENTUCKY  
EFFECTIVE

MAY 23 1995

PURSUANT TO 807 KAR 5:011,  
SECTION 9 (1)

BY: Jordan C. Neel  
FOR THE PUBLIC SERVICE COMMISSION

Issued: June 13, 1995

Effective: May 23, 1995

*Deborah A. Nisch* President, Cincinnati, Ohio  
Vice President  
Integrated Corporate Planning for

ACCESS SERVICE TARIFF  
PSC No. 2

CINCINNATI BELL TELEPHONE COMPANY

1st Revised Page 488  
Cancels Original Page 488

8. Billing and Collection Services (Cont'd)

8.4 Billing Information Service (Cont'd)

8.4.4 Oblinations of the Customer (Cont'd)

- (E) The customer shall be responsible for all contacts and inquiries from its end users concerning Billing Information Service.
- (P) The customer shall not publicize or represent to others that the Telephone Company jointly participates with the customer in the development of the customer's end user records, accounts, data bases or market data, records, files and data bases or other systems it assembles through the use of Billing Information Services.

(D)

(D)

PUBLIC SERVICE COMMISSION  
OF KENTUCKY  
EFFECTIVE

MAY 23 1995

PURSUANT TO 807 KAR 5:011,  
SECTION 9 (1)

BY: Jordan C. Neel  
FOR THE PUBLIC SERVICE COMMISSION

Issued: June 13, 1995

Effective: May 23, 1995

*Deborah A. Nisch*  
Vice President  
Integrated Corporate Planning for

President, Cincinnati, Ohio

ACCESS SERVICE TARIFF  
PSCK No. 2

CINCINNATI BELL TELEPHONE COMPANY

1st Revised Page 489  
Cancels Original Page 489

8. Billing and Collection Services (Cont'd)

8.4 Billing Information Service (Cont'd)

8.4.5 Payment Arrangements

(A)

(D)

(D)

(B) Cancellation of a Special Order

A customer may cancel a Special Order for Billing Information Service on any date prior to the service date. The cancellation date is the date the Telephone Company receives written or verbal notice from the customer that the Special Order is to be cancelled. The verbal notice must be followed by written confirmation within 10 days. The service date for a Billing Information Service is the date the Telephone Company notifies the customer that the Telephone Company is ready to provide Billing Information Service reports or receive interrogation requests.

PUBLIC SERVICE COMMISSION  
OF KENTUCKY  
EFFECTIVE

**MAY 23 1995**

PURSUANT TO 807 KAR 5011,  
SECTION 9 (1)

BY: Jordan C. Neal  
FOR THE DIRECTOR

Issued: **June 13, 1995**

Effective: **May 23, 1995**

*Deborah A. Nisch*

President, Cincinnati, Ohio

Vice President

Integrated Corporate Planning for

8. Billing and Collection Services (Cont'd)

8.4 Billing Information Service (Cont'd)

8.4.5 Payment Arrangements (Cont'd)

(B) Cancellation of a Special Order (Cont'd)

When a customer cancels a Special Order for Billing Information Service after the order date but prior to the state of service, charges as listed following shall apply:

- (1) For any service, the appropriate per hour rate for all hours expended by the Telephone Company to provide the service.
- (2) For any service, any expense for equipment obtained for the service where such equipment cannot be reused within six months.

(C) Changes to Special Orders

When a customer requests changes for a pending Special Order for Billing Information Service, they will be undertaken if they can be accommodated by the Telephone Company. Any additional time required on the part of the Telephone Company personnel will be billed to the customer at the appropriate hourly charges.

8.4.6 Rate Regulations

- (A) The number and type of records for which charges apply as set forth in 8.4.7 following will be accumulated by the Telephone Company and the Telephone Company will bill the customer in accordance with these accumulations. A record is a logical grouping of information as described in the programs that process the information, print the paper output, and load the magnetic tape or data file used to supply the detail which is data-transmitted or put on fiche. For each service and type of output ordered, the number of records processed by the Telephone Company to prepare the output will be used to determine the charges. The number of records processed will be determined using the number of records input to or the number of records output from the programs that process the information, print the paper output and load the magnetic tape or data file, whichever number of records is higher.
- PUBLIC SERVICE COMMISSION  
OF KENTUCKY  
EFFECTIVE  
MARCH 3 1992

Issued: February 7, 1992

*Robert E. Aigmon*

for

President, Cincinnati, Ohio

PURSUANT TO §07 KAR 5:011.

Effective: SECTION 9 (1)  
March 3, 1992

BY: *James D. Bell*  
PUBLIC SERVICE COMMISSION MANAGER

Vice President - Regulatory Affairs



ACCESS SERVICE TARIFF  
PSCK No. 2

CINCINNATI BELL TELEPHONE COMPANY

1st Revised Page 491  
Cancels Original Page 491

8. Billing and Collection Services (Cont'd)

8.4 Billing Information Service (Cont'd)

8.4.6 Rate Regulations (Cont'd)

- (B) The number of hours and fraction thereof for which charges apply as set forth in 8.4.7 following will be accumulated by the Telephone Company. The per hour rate is for the use of one hour of one Telephone Company programmer. The Telephone Company will bill the customer for hourly charges in accordance with these accumulations. The accumulated hours for each order will be summed and rounded to the nearest hour, except that when the total is less than one hour, one hour will be used to determine the charges.
- (C) When a CNA request is received, the Telephone Company will keep a count of the requests. The Telephone Company will bill the Customer in accordance with these records even though the Telephone Company was not able to provide a name and town location for all requests.
- (D) When records are entered on a data file or magnetic tape in order to provide information to a customer the per tape charge applies for each data file or tape prepared. In addition, the per record charge applies for each record entered on the data file or tape. The Telephone Company will determine the charges based on the number of data files or tapes prepared and on its count of the records entered on the data file or tape.

PUBLIC SERVICE COMMISSION  
OF KENTUCKY  
EFFECTIVE

(E)

MAY 23 1995

PURSUANT TO 807 KAR 5011,  
SECTION 9(1)

BY: Gordon C. Neal  
FOR THE PUBLIC SERVICE COMMISSION

The Provision of Billing Information Service per Special Order Charge applies for each Special Order accepted by the Telephone Company for any Billing Information Service.

(D)  
|

(D)  
|

Issued: June 13, 1995

Effective: May 23, 1995

*Deborah A. Nisch*

President, Cincinnati, Ohio

Vice President  
Integrated Corporate Planning for.

ACCESS SERVICE TARIFF  
PSCK No. 2

CINCINNATI BELL TELEPHONE COMPANY

1st Revised page 492  
Cancels Original Page 492

8. Billinn and Collection Services (Cont'd)

8.4 Billinn Information Service (Cont'd)

8.4.7 Rates and Charges

The rates and charges are:

(A) CRIS 10 Working Day Information Service,

|                               | <u>Rates*</u>  |
|-------------------------------|----------------|
|                               | <u>Service</u> |
| Account                       |                |
| <u>Detail</u> — <u>Detail</u> |                |

(D)  
|  
(D)  
(T)

- Paper output, per record processed ICB rates and charges apply.
- Magnetic tape, per record processed ICB rates and charges apply.
- per tape or data file ICB rates and charges apply.
- Fiche output, per record processed ICB rates and charges apply.

\* The Quick Turnaround per record charge and the per tape charge is three times the 10 working day per record charge and per tape charge.

(D)

(B)

(D)

PUBLIC SERVICE COMMISSION  
OF KENTUCKY  
EFFECTIVE

MAY 23 1995

(D)

(C)

PURSUANT TO 807 KAR 5:011,  
SECTION 9(1)

(D)

BY: Jordan C. Neal  
FOR THE PUBLIC SERVICE COMMISSION

(D)

Issued: June 13, 1995

Effective: **May 23, 1995**

*Sarah A. Nisch*

President, Cincinnati, Ohio

Vice President  
Integrated Corporate Planning for

ACCESS SERVICE TARIFF  
PSCK No. 2

CINCINNATI BELL TELEPHONE COMPANY

1st Revised Page 493  
Cancels Original Page 493

8. Billinn and Collection Services (Cont'd)

8.4 Billinn Information Service (Cont'd)

8.4.7 Rates and Charges (Cont'd)

|  | <u>RATES</u>                    | (T)             |
|--|---------------------------------|-----------------|
| (D) Program Development charge,<br>- Basic, per hour<br>(applicable to work performed<br>by the Telephone Company) | ICB rates and<br>charges apply. | (C)<br>(C)      |
|  |                                 | (D)<br> <br>(D) |
| (E) CNA Information Service,<br>- CNA interrogation,<br>per request received                                       | ICB rates and<br>charges apply. | (T)             |
| - CNA interrogation confirmation,<br>per request confirmed   | ICB rates and<br>chargas apply. |                 |
| (F) Data transmission,<br>- per record transmitted   |                                 | (C)<br>(C)      |
| (G)  |                                 | (D)<br> <br>(D) |
|  |                                 | (D)             |
| (H) Updating of customer data bases or files,<br>- per record transmitted  | 0.0389                          | (T)             |
| (I) Provision of Bill Information Service,<br>- per Special Order  | 10.51                           | (T)             |

PUBLIC SERVICE COMMISSION  
OF KENTUCKY  
EFFECTIVE 0070(R)

MAY 23 1995

PURSUANT TO 807 KAR 5:011,  
SECTION 9 (1)

BY: Jordan C. Neal  
FOR THE PUBLIC SERVICE COMMISSION

Issued: June 13, 1995

Effective: May 23, 1995

*Deborah A. Nisch* President, Cincinnati, Ohio  
Vice President  
Integrated Corporate Planning for

ACCESS SERVICE TARIFF  
PSCK No. 2

CINCINNATI BELL TELEPHONE COMPANY

Original Page 494

9. Directory Assistance Service

The Telephone Company will provide Directory Assistance (DA) Service to a customer from Directory Assistance Service locations (DA location).

9.1 General Description

DA Service provides Directory Access Service to DA locations, use of DA access equipment, and use of DA operators to provide telephone numbers.

9.2 Undertaking of the Telephone Company

- (A) A Telephone Company DA operator, when furnished a name and locality, will provide or attempt to provide the telephone number listed in the Telephone Company DA records associated with the name given at the rates and charges as set forth in 9.6 following. The Telephone Company's contact with the customer's end user shall be limited to that effort necessary to process a customer's end user's request for a telephone number; and the Telephone Company will not transfer, forward or redial a customer's end user call to any other location for any purpose other than provision of DA Service.
- (B) A maximum of two (2) requests for telephone numbers will be accepted per call to the DA operator.
- (C) A telephone number which is not listed in DA records will not be available to the customer's end user.
- (D) The Telephone Company will specify the DA location which provides the DA Service for each numbering plan area code (NPA). The DA locations are as shown in NATIONAL EXCHANGE CARRIER ASSOCIATION, INC TARIFF F.C.C. No. 4.

When it becomes necessary, as determined by the Telephone Company, to change a DA location, the Telephone Company will notify the involved customers **six** months prior to the change. For such changes, the regulations as set forth in 2.1.7 preceding apply.

- (E) When DA Service is ordered, Directory Access Service will be provided between the customer premises and the DA location by the Telephone Company at rates and charges as set forth in 9.6 following.

PUBLIC SERVICE COMMISSION  
OF KENTUCKY  
EFFECTIVE

MAR 3 1992

PURSUANT TO 807 KAR 5:011,  
SECTION 9 (1)

BY: *Charles J. Miller*  
Effective: March 3, 1992

Issued: February 7, 1992  
*Robert E. Sigmon* for

President, Cincinnati, Ohio

Vice President - Regulatory Affairs

ACCESS SERVICE TARIFF  
PSCK No. 2

CINCINNATI BELL TELEPHONE COMPANY

1st Revised Page 495  
Cancels Original Page 495

9. Directory Assistance Service (Cont'd)

9.2 Undertaking of the Telephone Company (Cont'd)

(E) (Cont'd)

(1) General

Each Directory Access Service will consist of the following:

- An Interface Group equipped with an available Premises Interface Code at the customer's premise.
- Directory Transport between the premise of the ordering customer and the DA Switch location.

(T)

When required by the Telephone Company, a separate Directory Access Service trunk group will be provided for DA Service for each NPA. Separate trunk groups will be required when the Telephone Company notifies the customer that the mechanized search of its data base and its mechanized operator practices require a mechanized identification of the NPA code for which the customer's end user desires DA information.

Further, when an access tandem is available and is provided, the Directory Access Service will be provided, at Telephone Company choice, either as a separate Directory Access Service trunk group or in combination with Feature Group B, C or D Switched Access Service.

(2) Interface Group and Premise Interface Code

Interface Groups 2, 6 and 9 as set forth in 6.1.3(B)(5) preceding are available for Directory Access Service. When only Directory Access Service is provided, only the following Premise Interface Codes are available:

(C)

|         |        |        |
|---------|--------|--------|
| 4DS9-15 | 6EA2-E | 4RV2-0 |
| 4DS6-44 | 6EA2-M |        |
|         | 4SF3   |        |

PUBLIC SERVICE COMMISSION  
OF KENTUCKY  
EFFECTIVE

(C)  
|  
(C)

MAY 23 1995

PURSUANT TO 807 KAH 5:011,  
SECTION 9(1)

BY: Jordan C. Neal  
FOR THE PUBLIC SERVICE COMMISSION

Issued: June 13, 1995

Effective: **May 23, 1995**

*Neborah A. Nisch* President, Cincinnati, Ohio  
Vice President  
Integrated Corporate Planning for

ACCESS SERVICE TARIFF  
PSCK No. 2

CINCINNATI BELL TELEPHONE COMPANY

1st Revised Page 496  
Cancels Original Page 496

9. Directory Assistance Service (Cont'd)

9.2 Undertaking of the Telephone Company (Cont'd)

(E) (Cont'd)

(2) Interface Group and Premise Interface Code (Cont'd)

Such Premise Interface Codes are described in 6.1.3(B)(5) (T)  
preceding. When Directory Access Service is combined with  
Feature Group B, C or D Switched Access Service, the Premise  
Interface Code for the combination will be the available  
Premise Interface Code provided for the Feature Group B, C  
or D Switched Access Service ordered by the customer.  
Except as set forth in 9.4(A) following, the Interface  
Groups and Premises Interface Codes provided under a Special  
Order for Directory Access Service are subject to the order  
conditions as set forth in 5. preceding. For purposes of (T)  
applying the order regulations, a DA Switch location is  
considered to be a customer end user serving wire center.

(3) Directory Transport

Directory Transport provides the transmission facilities and  
transport termination between the premises of the ordering  
customer and the DA Switch locations. For purposes of (T)  
determining Directory Transport mileage, distance will be  
measured from the wire center that normally serves the  
customer premises to the DA location(s).

facilities as set forth in 6.1.3 preceding. The two-way  
voice frequency path transports calls in the terminating  
direction (from the premises of the ordering customer to  
the DA switch location). The following rate elements,  
which are more fully described in 6.1.3 preceding, are

PUBLIC

MAY 23 1995

PURSUANT TO 807 KAR 5.011,  
SECTION 9 (1)

BY: Jordan C. Neel  
FOR THE PUBLIC SERVICE COMMISSION

Issued: June 13, 1995

Effective: ~~May~~ 23, 1995

*Deborah A. Nisch*

President, Cincinnati, Ohio

Vice President  
Integrated Corporate Planning for

ACCESS SERVICE TARIFF  
PSCK No. 2

CINCINNATI BELL TELEPHONE COMPANY

Original Page 496.1

PUBLIC SERVICE COMMISSION  
OF KENTUCKY  
EFFECTIVE

9. Directory Assistance Service (Cont'd)

9.2 Undertakinn of the Telephone Company (Cont'd)

(E) (Cont'd)

(3) Directory Transport (Cont'd)

- MAY 23 1995
- PURSUANT TO 807 KAR 5:011,  
SECTION 9(1)
- BY: Jordan C. [Signature]  
FOR THE PUBLIC SERVICE COMMISSION
- Entrance Facility for the transport of the DA call from the customer's premises to the serving wire center of that premises wer dedicated facilities.
  - Direct Trunked Transport for the transport of the DA call from the customer's serving rire center to the DA switch location over dedicated facilities.
  - Tandem Switched Transport (i.e., Tandem Switched Transmission, and Tandem Switching) for the transport of the DA call from the customer's serving vire center to the DA switch location with switching at a tandem.
  - Interconnection Charge for the Switched Transport costs that are not recovered by the Entrance Facility, Direct Trunked Transport. Tandem Switched Transport, Multiplexing or CCSAC Link and port rates.
  - Multiplexing DS3 to DS1 Multiplexing charges apply when a High Capacity DS3 Entrance Facility or Direct Trunked Facility is connected rith High Capacity DS1 Direct Trunked Transport. The DS3 to DS1 multiplexer will convert a 44.736 Mbps channel to 28 DS1 channels using digital time division multiplexing.
  - DS1 to Voice grade Multiplexing charges apply when a High Capacity DS1 Entrance Facility or Direct Trunked Facility is connected rith Voice Grade Direct Trunked Transport. The DS1 to voice multiplexer rill convert a 1.544 Mbps channel to 24 Voice Grade channels.

Multiplexing is *only* available at rire centers identified in NATIONAL EXCHANGE CARRIER ASSOCIATION, INC. TARIFF FCC NO. 4, WIRE CENTER INFORMATION.

Issued: June 13, 1995

Effective: May 23, 1995

*Deborah A. Nisch*  
Vice President  
Integrated Corporate Planning &or

President, Cincinnati, Ohio

(N)

ACCESS SERVICE TARIFF  
PSCK No. 2

CINCINNATI BELL TELEPHONE COMPANY

1st Revised Page 497  
Cancels Original Page 497

9. Directory Assistance Service (Cont'd)

9.2 Undertaking of the Telephone Company (Cont'd)

(E) (Cont'd)

(3) Directory Transport (Cont'd)

The customer will determine whether the Directory Access Service is to be routed directly to a DA Switch location or through an access tandem switch appropriately equipped for DA measurement and served by DA trunks to the DA Switch location when such an access tandem switch is available. The combination of Feature Group B or D Switched Access Service with DA Service will only be provided at such available and appropriately equipped access tandem switches.

(C)  
(T)  
(T)  
(T)  
(D)  
|  
(D)

When Directory Transport is provided using a **Direct-Trunked Transport** to the DA Switch location, no address signaling is provided. When Directory Transport is provided with the use of an access tandem switch, wink start-start pulsing signaling is provided at the access tandem switch. The customer will be notified by the Telephone Company when access tandem routing is provided and the customer shall address each call to the DA location using NPA + 555 + 1212 or when required by the Telephone Company, 555-1212. Only NPA codes handled by the DA location served by the access tandem switch will be processed.

(C)  
(C)

PUBLIC SERVICE COMMISSION  
OF KENTUCKY  
EFFECTIVE

MAY 23 1995

PURSUANT TO 807 KAR 5.011,  
SECTION 9 (1)

BY: Jason C. Neal  
FOR THE PUBLIC SERVICE COMMISSION

Issued: June 13, 1995

Effective: May 23, 1995

*Deborah Nisch*

President, Cincinnati, Ohio

Vice President

Integrated Corporate Planning for



CINCINNATI BELL TELEPHONE COMPANY

1st Revised Page 498  
Cancels Original Page 498

9. Directory Assistance Service (Cont'd)

9.2 Undertaking of the Telephone Company (Cont'd)

(E) (Cont'd)

(3) Directory Transport (Cont'd)

The number of Directory Transport transmission paths provided is based on the customer's order and is determined by the Telephone Company in a manner similar to Switched Access Service transmission paths as set forth in 6.5.5 preceding.

(D)  
|  
(D)

Except as set forth in 9.4 (A) following, Directory Transport provided under a Special Order is subject to the order conditions as set forth in 5. preceding.

(D)  
|  
(D)

(4) Special Facilities Routing

A customer may request that Directory Access Service be provided via Special Facilities Routing. The regulations, rates and charges for Special Facility Routing (Avoidance, Diversity and Cable Only) are as set forth in 11. following.

PUBLIC SERVICE COMMISSION  
OF KENTUCKY  
EFFECTIVE

MAY 23 1995

PURSUANT TO 807 KAH 5:011,  
SECTION 9(1)

BY: Jordan C. Neel  
FOR THE PUBLIC SERVICE COMMISSION

Issued: June 13, 1995

Effective: **May 23, 1995**

*Deborah A. Nisch*

President, Cincinnati, Ohio

Vice President  
Integrated Corporate Planning for

ACCESS SERVICE TARIFF  
PSCK No. 2

CINCINNATI BELL TELEPHONE COMPANY

1st Revised Page 499  
Cancels Original Page 499

9. Directory Assistance Service (Cont'd)

9.2 Undertaking of the Telephone Company (Cont'd)

(E) (Cont'd)

(5) Design Layout Report

The Telephone Company will provide to the customer the makeup of the facilities and services provided under this section as Directory Access Service. This information will be provided in the form of a Design Layout Report similar to that as set forth in 6.1.5. Design Layout Reports for Directory Access Service will be provided only when specifically requested by the customer. The Design Layout Report will be provided to the customer at no charge, and will be reissued or updated whenever the facilities provided for the customer's use are materially changed.

(6) Transmission Specifications

Directory Access Service is provided with either Type A or B Transmission Specification. The specifications associated with the parameters are guaranteed to the DA Switch location, (T) whether routed directly or via an access tandem. Type B Transmission Specification is provided with Interface Groups 2, 6 and 9 when routed direct to a DA location. Type A Trans- (C) mission Specification is provided with Interface Groups 2, 6 and 9 when routed via an access tandem switch. (C)

When DA Service is combined with Feature Group D Switched Access Service, Type A Transmission Specification is provided. When DA Service is combined with Feature Group B Switched Access Service, Type B Transmission Specification is provided for Interface Group 2, 6 and 9. (C)  
(C)

Type A and B Transmission Specifications are set forth in 6.4.1 preceding.

PUBLIC SERVICE COMMISSION  
OF KENTUCKY  
EFFECTIVE

MAY 23 1995

PURSUANT TO 807 KAR 5:011,  
SECTION 9(1)

BY: Jordan C. Neal

Effective: MAY 23 1995

Issued: June 13, 1995

Deborah A. Nisch President, Cincinnati, Ohio  
Vice President  
Integrated Corporate Planning for

9. Directory Assistance Service (Cont'd)

9.2 Undertaking of the Telephone Company (Cont'd)

(E) (Cont'd)

(7) Acceptance Testing and Testing Capabilities

The acceptance testing and testing capabilities for Directory Access Service traffic routed through an access tandem are the same as those for the associated Feature Group D end office switching. The acceptance testing for Directory Access Service traffic routed directly to or routed in a separate trunk group through an access tandem to the DA Switch location will be as set forth in 6.1.6 preceding. The testing capabilities for Directory Access Service traffic routed directly to or routed in a separate trunk group through an access tandem to the DA Switch location will be as set forth for cooperative scheduled testing or manual scheduled testing in Section 13 following.

- (F) Trunk side switching is provided at the DA Service access location. The DA Service access location will provide trunk answer and disconnect supervisory signaling.
- (G) The Telephone Company will distribute the calls received over the Directory Access Services to the DA operators using the DA location access equipment.
- (H) In the event that the telephone number is unavailable to the DA operator, no credit applies for the charge for the call to the DA operator. When the DA location or DA operator equipment or terminals are out of service due to a Telephone Company equipment failure or an incorrect number is provided, a credit as set forth in 9.4(H) following will apply.
- (I) DA Service may, at the option of the customer, be provided for interstate and intrastate communications. When the customer requests such mixed access, the interstate DA Service charges will be determined by the Telephone Company using the data furnished by the customer as set forth in 2.3.14 preceding.
- (J) The Telephone Company does not provide Directory Assistance Service for 500 NXX, 800 NXX Access Service or 900 NXX Access Service. (T)

ACCESS SERVICE TARIFF  
PSCK No. 2

CINCINNATI BELL TELEPHONE COMPANY

1st Revised Page 501  
Cancels *Original* Page 501

9. Directory Assistance Service (Cont'd)

9.3 Obliaations of the Customer

- (A) The customer shall determine and order the trunks and interface type of Directory Access Service it needs for DA Service. (C)
- (B) When DA Service is initially ordered, the customer shall order the service for at least six months. Thereafter, additional service may be ordered for a minimum of six months. Not later than three months prior to the end of the six month period, the customer shall notify the Telephone Company if the service is to be discontinued at the end of the six month period. If no notice is received from the customer the Telephone Company will automatically extend the service for another six months and all appropriate charges as set forth in 9.6 following for another six months will apply.
- (C) The customer facilities at the premises of the ordering customer shall provide the necessary on-hook and off-hook supervision.
- (D) When requested by the Telephone Company, the customer shall order a separate trunk group for DA Service for each NPA. The conditions when the customer will be requested to order separate trunk groups for each NPA are set forth in 9.2(E)(1) preceding.
- (E) (Reserved)
- (F) The customer understands that DA operators will respond to only two (2) telephone number requests per call and will not transfer, forward or redial the call to another location for any purposes other than the provision of DA Service.

PUBLIC SERVICE COMMISSION,  
OF KENTUCKY  
EFFECTIVE

MAY 23 1995

PURSUANT TO 807 KAH5:011,  
SECTION 9(1)

BY: Jordan C. Neal  
FOR THE PUBLIC SERVICE COMMISSION

Issued: June 13, 1995

Effective: May 23, 1995

*Deborah A. Nisch*

President, Cincinnati, Ohio

Vice President  
Integrated Corporate Planning for

ACCESS SERVICE TARIFF  
PSCK No. 2

CINCINNATI BELL TELEPHONE COMPANY

1st Revised Page 502  
Cancels **Original** Page 502

9. Directory Assistance Service (Cont'd)

9.4 Payment Arrangements

(A) Minimum Periods

The minimum period for which DA Service and the Directory Access Service is provided and for which charges apply is *six* months. A minimum period of *six* months applies for each additional period of service ordered or extended.

If DA Service is discontinued prior to the end of each *six* month period, the charges that apply for the remaining months are the non-recoverable costs. Such costs include the non-recoverable cost of equipment and material ordered, provided or used, plus the non-recoverable cost of installation and removal including the costs of engineering, labor supervision, transportation, rights-of-way and other associated costs less estimated net salvage.

(B) Minimum Monthly Charge

DA service is subject to a minimum monthly charge. The minimum monthly charge consists of the following elements:

For those rate elements that are billed a flat monthly rate, i.e., Directory Transport options, the minimum monthly charge is the monthly rate as set forth in 9.6 following.

The minimum monthly charge for Directory Assistance Service calls is the charge as set forth in 9.6 following for the actual usage for the month.

PUBLIC SERVICE COMMISSION  
OF KENTUCKY  
EFFECTIVE

MAY 23 1995

PURSUANT TO 807 KAR 5:011,  
SECTION 9 (1)  
BY: Jordan C. Neel  
FOR THE PUBLIC SERVICE COMMISSION

(D)

(D)

Issued: June 13, 1995

Effective: **May** 23, 1995

 President, Cincinnati, Ohio  
Vice President  
Integrated Corporate Planning for

ACCESS SERVICE TARIFF  
PSCK No. 2

CINCINNATI BELL TELEPHONE COMPANY

2nd Revised Page 503  
Cancels 1st Revised Page 503

9. Directory Assistance Service (Cont'd)

9.4 Payment Arrangements (Cont'd)

(D)

(D)

PUBLIC SERVICE COMMISSION  
OF KENTUCKY  
EFFECTIVE

MAY 23 1995

PURSUANT TO 807 KAR 5:011,  
SECTION 9(1)

BY: Jordan C. Neel  
FOR THE PUBLIC SERVICE COMMISSION

Issued: June 13, 1995

Effective: May 23, 1995

*Deborah Nisch*

President, Cincinnati, Ohio

Vice President  
Integrated Corporate Planning for

9. Directory Assistance Service (Cont'd)

9.4 Payment Arrangements (Cont'd)

(D) Cancellation of a Special Order

A customer may cancel a Special Order for DA Service on any date prior to the service date. The cancellation date is the date the Telephone Company receives written or verbal notice from the customer that the Special Order is to be cancelled. The verbal notice must be followed by written confirmation within 10 days.

When a customer cancels a Special Order for DA Service after the order date but prior to the start of service, the appropriate charges as set forth in 5. preceding apply for the Directory Access Service cancelled. In addition, a charge equal to any unrecoverable capital costs incurred by the Telephone Company will apply to the customer.

(E) Changes to Special Orders

When a customer requests changes to a pending order for DA Service, such changes will be undertaken if they can be accommodated by the Telephone Company. The appropriate charges as set forth in 5. preceding apply for the Directory Access Service changed. In addition, a charge equal to any other costs incurred by the Telephone Company because of the change will apply.

PUBLIC SERVICE COMMISSION  
OF KENTUCKY  
EFFECTIVE

MAR 3 1992

PURSUANT TO 807 KAR 5:011,  
SECTION 9 (1)

Effective BY: March 3, 1992  
PUBLIC SERVICE COMMISSION MANAGER

Issued: February 7, 1992

*Robert E. Aigmon*

for

President, Cincinnati, Ohio

Vice President - Regulatory Affairs

9. Directory Assistance Service (Cont'd)

9.4 Payment Arrangements (Cont'd)

(F) Moves

A move involves a change in the physical location of the point of termination at the customer premises or of the customer premises. Moves will be treated as set forth in 6.7.7 preceding and all associated nonrecurring charges will apply. Minimum period requirements will be established at the new location as set forth in 6.7.7 preceding. The customer will also remain responsible for satisfying all outstanding minimum period charges for the discontinued service.

(G) DA Service Rearrangements

Nonrecurring charges apply for service arrangements. Service rearrangements are as set forth in 6.7.1(C)(3) preceding. The Service Rearrangement Charges are as set forth in 6.7.1(C)(3) for the type of change provided by the Telephone Company.

(H) Credit Allowance for DA Service

PUBLIC SERVICE COMMISSION  
OF KENTUCKY  
EFFECTIVE

MAY 23 1995

PURSUANT TO 807 KAR 5011,  
SECTION 9(1)

BY: Jordan C. Neal  
FOR THE PUBLIC SERVICE COMMISSION

(1) When the DA Switch location or DA operator equipment or terminals are out of service due to a Telephone Company equipment failure or an incorrect number is provided and a customer DA call has been answered or forwarded to a DA operator, a credit allowance for a call answered or forwarded to the DA operator equal to the rate for a Directory Assistance Service Call as set forth in 9.6 following plus the rate for a Directory Transport call will be applied to the customer's charges.

(T)

(C)  
/  
(C)

(2) In addition to the credit as set forth in (1) preceding, when a DA operator or DA equipment provides an incorrect number for a call and the customer reports such occurrences to the Telephone Company, a credit allowance for such DA call will apply. The credit will be as set forth in (3) following. When the customer reports such a call and the number requested, the number provided and the reason the number provided is incorrect, the number of calls for which a credit will apply will be developed by the Telephone Company in cooperation with the customer.

Issued: June 13, 1995

Effective: May 23, 1995

Deborah A. Reese

President, Cincinnati, Ohio

Vice Resident  
Integrated Corporate Planning for



ACCESS SERVICE TARIFF  
PSCK No. 2

CINCINNATI BELL TELEPHONE COMPANY

2nd Revised Page 506  
Cancels 1st Revised Page 506

9. Directory Assistance Service (Cont'd)

9.4 Payment Arrangements (Cont'd)

(H) Credit Allowance for DA Service (Cont'd)

(3) When a DA call is not completed due to the failure of Directory Access Service to DA locations, DA access equipment or DA operator activities, a credit allowance for the Switched Access Service portion in the originating LATA of such DA call will apply. When the customer reports such a call and DA number dialed, time of the call and the date of the call, the number of calls for which a credit will apply will be developed by the Telephone Company in cooperation with the customer. The credit will be as set forth following:

- |   |             |
|---|-------------|
| a) Credit per call when Switched Access Service is billed using Transitional per minute rates                     | \$0.0044(R) |
| b) Credit per call when Feature Group A and/or B Switched Access Service is billed using Premium per minute rates | 0.0097(R)   |
| c) Credit per call when Feature Group C and/or D Switched Access Service is billed using Premium per minute rates | 0.0097(R)   |

(4) Credit allowances for other service interruptions will be provided as set forth in 2.4.4 preceding.

9.5 Rate Regulations

- (A) The Directory Assistance service call charge as set forth in 9.6 (A) following, applies for each call to DA Service. A call is a call which has been answered by or forwarded to a DA operator. The charge applies whether or not the DA operator provides the requested telephone number. The number of calls answered or forwarded to DA operators will be accumulated by Telephone Company measuring equipment. A credit for the provision of an incorrect telephone number will be applied as set forth in 9.4(h) preceding.

PUBLIC SERVICE COMMISSION  
OF KENTUCKY  
EFFECTIVE

MAY 23 1995

PURSUANT TO 807 KAR 5.011,  
SECTION 9(1)

BY: Jordan C. Neel  
FOR THE PUBLIC SERVICE COMMISSION

Issued: June 13, 1995

Effective: May 23, 1995

Deborah A. Nisch President, Cincinnati, Ohio  
Vice President  
Integrated Corporate Planning for

9. Directory Assistance Service (Cont'd)9.5 Rate Regulations (Cont'd)

- (B) The mileage for Directory Transport is measured from the serving wire center for the premises of the ordering customer to the DA location. Title Page notwithstanding, these two wire centers may be in different LATAS. In addition, the premises of the ordering customer must be in the LATA where DA service is requested or in the LATA where the DA location is located. The measurement will be performed as set forth in 6.7.13 preceding.
- (C) The charge per call for Directory Transport, as set forth in 9.6 (B) following, applies for each call to DA service. A call is as set forth in (A) preceding. The number of calls will be accumulated as set forth in (A) preceding.

9.6 Rates and Charges

The rates and charges are:

|   | <u>Rates</u>  |
|---|---|
| (A) Directory Assistance Service call, each | \$0.3000(I)   |
| (B) Directory Access Service                |   |
| - Directory Access Installation Charge      | Charges are the same as those set forth in 6.8.2(c) preceding |
| - Directory Transport                       |   |

The following Switched Transport charges set forth in 6.8.2 preceding are also applicable to Directory Transport Service and will be assessed on the same basis as the Switched Transport rate regulations described in 6.1.3 preceding:

- Entrance Facility
- Direct Trunked Transport
- Multiplexing

ACCESS SERVICE TARIFF  
PSCK No. 2

CINCINNATI BELL TELEPHONE COMPANY

2nd Revised page 507.1  
Cancels 1st Revised Page 507.1

9. Directory Assistance Service (Cont'd)

(B) Directory Access Service

The following Switched Transport charges will be assessed on a per call basis unlike switched transport which is assessed on a minute-of-use basis. However, all other terms and conditions, as set forth in 6.1.3, will apply.

|                                | <u>Rate Per Call</u> |     |
|--------------------------------|----------------------|-----|
| Tandem - Switched Transmission |                      |     |
| Fixed                          | \$0.0002             |     |
| Per Mile                       | \$0.0001             |     |
| Tandem - Switching             | \$0.001168           |     |
| Interconnection Charge         | \$0.0000             |     |
| Multiplexing Charge            | \$0.00001            | (C) |

10. Federal Government Specialized Service or Arrangements

10.1 General

This section covers Access Services that are provided to a customer for use only by agencies or branches of the Federal Government and other users authorized by the Federal Government. Services provided to state emergency operations centers are included. These services provide for command and control communications, including communications for national security, emergency preparedness and presidential requirements. They are required to assure continuity of Government in emergency and crisis situations and to provide for national security. In addition, this section covers Telecommunications Service Priority (TSP) System services and procedures as set forth in 10.8.1(D) since it is administered by the Federal Government.

Services for command and control communications and for national security and emergency preparedness sometimes require short notice and short duration service provisions. These provisions are especially needed to meet presidential requirements or in response to natural, man-made, or declared emergencies. Requirements of this type cannot be forecasted and are usually needed for a relatively short period. The provision of service under these conditions may require the availability of facilities, such as portable microwave equipment, which are provided on a temporary basis by the Telephone Company or Customer.

10.2 Emergency Conditions

These services will be provided on the date requested or as soon as possible thereafter when the emergency falls into one of the following categories:

- (A) State of crisis declared by the National Command Authorities (includes commitments made to the National Communications System in the "National Plan for Emergencies and Major Disasters"),

PUBLIC SERVICE COMMISSION  
OF KENTUCKY  
EFFECTIVE

MAR 3 1992

PURSUANT TO 807 KAR 5:011,  
SECTION 9(1)

Effective: March 3, 1992  
BY: [Signature]  
PUBLIC SERVICE COMMISSION

Issued: February 7, 1992

Robert E. Aigmon for

President, Cincinnati, Ohio

**Vice President - Regulatory Affairs**

10. Federal Government Specialized Service or Arrangements (Cont'd)

10.2 Emergency Conditions (Cont'd)

- (B) Efforts to protect endangered **U.S.** personnel or property both in the **U.S.** and abroad. (Includes space vehicle recovery and protection efforts.)
- (C) Communications requirements resulting from hostile action, a major disaster or a major civil disturbance.
- (D) The director (Cabinet level) of a Federal department, Commander of a Unified/Specified Command, or head of a military department has certified that a communications requirement is **so** critical to the protection of life and property or to the National Defense that it must be processed immediately.
- (E) Political unrest in foreign countries which affect the national interest.
- (F) Presidential Service.

10.3 Intervals to Provide Service

Certain services provided under the provisions of this section of the tariff are provided on an individual case basis. Therefore, orders for such service shall be placed under the Negotiated Interval provisions set forth in 5.2.1(B) preceding.

**PUBLIC SERVICE COMMISSION  
OF KENTUCKY  
EFFECTIVE**

MAR 3 1992

**PURSUANT TO 807 KAR 5:011,  
SECTION 9(1)**

Issued: February 7, 1992

Effective: March 3, 1992

*Robert E. Aigmon* for

President, Cincinnati, Ohio

Vice President - Regulatory Affairs

ACCESS SERVICE TARIFF  
PSCK No. 2

CINCINNATI BELL TELEPHONE COMPANY

Original Page 510

10. Federal Government Specialized Service or Arrangements (Cont'd)

10.4 Safeguarding of Service

10.4.1 Facility Availability

In order to insure communications during periods of emergency, the Telephone Company will, within the limits of good management, make available the necessary facilities to restore service in the event of damage or to provide temporary emergency service as set forth in 10.8.1(D) and 10.8.3(D) following.

10.4.2 Utilization of Government Owned Facilities

In order to meet the requirements of agencies or branches of the Federal Government, the Telephone Company may utilize government-owned facilities, when necessary to provide service.

10.5 Federal Government Regulations

In accordance with Federal Government Regulations, all service provided to the Federal Government will be billed in arrears. However, this provision does not apply to other customers that obtain services under the provisions of this tariff to provide their services to the Federal Government.

10.6 Mileage Application

Mileage, when used for rate application in this section of the tariff, shall be determined by the V and H Coordinates Method as set forth in the NATIONAL EXCHANGE CARRIER ASSOCIATION, INC., WIRE CENTER AND INTER-CONNECTION INFORMATION, TARIFF F.C.C. No. 4 and administered as set forth in 7.4.6 preceding.

PUBLIC SERVICE COMMISSION  
OF KENTUCKY  
EFFECTIVE

MAR 3 1992

PURSUANT TO 807 KAR 5:011.  
SECTION 9 (1)

BY: George J. Kelley  
PUBLIC SERVICE COMMISSION MANAGER

Issued: February 7, 1992  
Robert E. Aigmon for

President, Cincinnati, Ohio

Effective: March 3, 1992

Vice President - Regulatory Affairs

ACCESS SERVICE TARIFF  
PSC No. 2

CINCINNATI BELL TELEPHONE COMPANY

1st Revised Page 511  
Cancels Original Page 511

10. Federal Government' Specialized Service or Arrangements (Cont'd)

10.7 Move Charges

When service without a maximum termination liability charge associated with it, as set forth in 10.8.1 and 10.8.2 following is moved to a new location **within** the same building, or to a different building, all associated nonrecurring charges will apply. (C)  
(C)

When service with a maximum termination liability charge associated with it, as set forth in 10.8.1 and 10.8.2 following, is moved and is reinstalled at a new location, the customer may elect:

- to pay the unexpired portion of the maximum termination liability charge for the service, if any, with the application of a nonrecurring charge and the establishment of a new maximum termination liability charge for such service at the new location, or
- to continue service subject to the unexpired portion of the maximum termination liability charge, if any, and pay the estimated costs of moving such service, provided that the customer requests these charges be quoted prior to ordering the service move. Charges for moving such service will be based on estimated costs attributable to the move.

Move charges include the estimated costs of removal, restoration of services or facilities necessitated by the move, transportation, storage, reinstallation, engineering, labor, supervision, materials, administration, and any other specific items of cost directly attributable to the move.

PUBLIC SERVICE COMMISSION  
OF KENTUCKY  
EFFECTIVE

MAY 23 1995

PURSUANT TO 807 KAA 5:011,  
SECTION 9(1)

BY: Jordan C. Neal  
FOR THE PUBLIC SERVICE COMMISSION

Issued: June 13, 1995

Effective: May 23, 1995

*Deborah A. Nisch*

President, Cincinnati, Ohio

Vice President  
Integrated Corporate Planning for

ACCESS SERVICE TARIFF  
PSCK No. 2

CINCINNATI BELL TELEPHONE COMPANY

Original Page 512

10. Federal Government Specialized Service or Arrangements (Cont'd)

10.8 Service Offerings

The following unique services are provided to a customer for use only by agencies or branches of the Federal Government, other authorized users and state emergency operations centers. The rates and charges for certain services shall be developed on an individual case basis and shall be consistent with the rates and charges for services offered in other sections of this tariff.

10.8.1 Type and Description

(A) Voice Grade Special Access Services

(1) Voice Grade Secure Communications Type I

Approximate bandwidth of 10-50,000 Hertz. Furnished for two-point secure communications on two-wire or four-wire metallic facilities between IC premises and end user's premises. Services are conditioned as follows:

T-3 Conditioning - The absolute loss (referenced to 1 milliwatt) with respect to frequency shall not exceed:

15 dB at 10 Hz  
13 dB at 100 Hz  
9 dB at 1,000 Hz  
20 dB at 10,000 Hz  
30 dB at 50,000 Hz

PUBLIC SERVICE COMMISSION  
OF KENTUCKY  
EFFECTIVE

MAR 3 1992

PURSUANT TO 807 KAR 5:011,  
SECTION 9 (1)

BY:   
PUBLIC SERVICE COMMISSION MANAGER

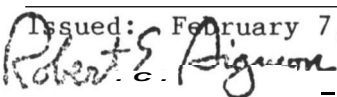
Issued: February 7, 1992  
 for

President, Cincinnati, Ohio

Effective: March 3, 1992

Vice President - Regulatory Affairs



ACCESS SERVICE TARIFF  
PSCK No. 2

CINCINNATI BELL TELEPHONE COMPANY

Original Page 513

10. Federal Government Specialized Service or Arrangements (Cont'd)

10.8 Service Offerings (Cont'd)

10.8.1 Type and Description (Cont'd)

(A) Voice Grade Special Access Services (Cont'd)

(1) Voice Grade Secure Communications Type I (Cont'd)

Additional conditioning (available in one or two directions on four-wire facilities only) to provide the following characteristics:

The absolute loss (referenced to one milliwatt) with respect to frequency shall not exceed:

0 db at 1,000 Hz  
± 1 dB between 1,000 Hz and 40,000 Hz  
± 2 dB between 10 Hz and 50,000 Hz  
(+ means more loss)

The net loss of the conditioned service (with or without additional conditioning) shall not vary by more than four dB at 1,000 Hz from the levels specified above. Voice frequency signaling or supervisory tones can be transmitted.

(2) Voice Grade Secure Communications Type II

Approximate bandwidth 10-50,000 Hz. Furnished on four-wire metallic facilities for duplex operation for two-point secure communications between an IC premises on an end user's premises and an end user's premises. Services are conditioned as follows:

G-1 Conditioning - The absolute loss with respect to frequency and the net loss variation shall be the same as Voice Grade Secure Communications Type I services without additional conditioning. Voice frequency signaling or supervisory tones can be transmitted.

PUBLIC SERVICE COMMISSION  
OF KENTUCKY  
EFFECTIVE

MAR 3 1992

PURSUANT TO P07 KAR 5.011,

SECTION 9 (1)

Effective: March 3, 1992

BY: [Signature]  
PUBLIC SERVICE COMMISSION MANAGER

Issued: February 7, 1992

Robert E. Aigmon for  
President, Cincinnati, Ohio

Vice President - Regulatory Affairs

ACCESS SERVICE TARIFF  
PSC No. 2

CINCINNATI BELL TELEPHONE COMPANY

Original Page 514

10. Federal Government Specialized Service or Arrangements (Cont'd)

10.8 Service Offerings (Cont'd)

10.8.1 Type and Description (Cont'd)

(A) Voice Grade Special Access Services (Cont'd)

(3) Voice Grade Secure Communications Type III

Approximate bandwidth 10-50,000 Hz. Furnished on four-wire metallic facilities for duplex operation for two-point secure communications between an IC premises switch and an end user's premises. Services are conditioned as follows:

G-2 Conditioning - The absolute loss with respect to frequency and the net loss variation from the switch to an end user's premises shall be the same as Voice Grade Secure Communications Type I services without additional conditioning; from an end user's premises to the switch shall be the same as Voice Grade Secure Communications Type I services with additional conditioning. Voice frequency signaling or supervisory tones can be transmitted.

(4) Voice Grade Secure Communications Type IV

Approximate bandwidth 10-50,000 Hz. Furnished on four-wire metallic facilities for duplex operation for two-point secure communication between two IC premises switches. Services are conditioned as follows:

G-3 Conditioning - The absolute loss with respect to frequency and the net loss variation shall be the same in both directions of transmission as Voice Grade Secure Communications Type I services with additional conditioning. Voice frequency signaling or supervisory tones can be transmitted.

PUBLIC SERVICE COMMISSION  
OF KENTUCKY  
EFFECTIVE

MAR 3 1992

Issued: February 7, 1992

PURSUANT TO 807 KAR 5-011  
Effective: March 3, 1992  
SECTION 9 (1)

*Robert E. Sigmon* for

President, Cincinnati, Ohio

BY: *[Signature]*  
PUBLIC SERVICE COMMISSION

Vice President - Regulatory Affairs

ACCESS SERVICE TARIFF  
PSCK No. 2

CINCINNATI BELL TELEPHONE COMPANY

Original Page 515

10. Federal Government Specialized Service or Arrangements (Cont'd)

10.8 Service Offerings (Cont'd)

10.8.1 Type and Description (Cont'd)

(B) Wideband Digital Special Access Service

Service arrangements for secured communications to accommodate the transmission of binary digital baseband signals in a random polar format.

(1) Wideband Secure Communications Type I

For transmission at the rate of 18,750 bits per second.

(2) Wideband Secure Communications Type II

For transmission at the rate of 50,000 bits per second.

(3) Wideband Secure Communications Type III

To accommodate the transmission of restored polar two-level facsimile signals with a minimum signal element width of twenty microseconds at a rate of 50,000 bits per second.

To accommodate the transmission of binary digital baseband signals in a random polar format at the rate of 50,000 bits per second.

(C) Special Routing Access Service

Special Routing Access Service is furnished only to an IC for an agency or branch of the Federal Government. This service provides the customer's end users the ability to originate and terminate calls to or from the customer's premises utilizing a Special Routing Plan.

PUBLIC SERVICE COMMISSION  
OF KENTUCKY  
EFFECTIVE

MAR 3 1992

PURSUANT TO 807 KAR 5:011,

SECTION 9 (1)

Effective: March 3, 1992

BY: *[Signature]*  
PUBLIC SERVICE COMMISSION MANAGER

Issued: February 7, 1992

*Robert E. Aizmon*

for

President, Cincinnati, Ohio

Vice President - Regulatory Affairs

ACCESS SERVICE TARIFF  
PSCK No. 2

CINCINNATI BELL TELEPHONE COMPANY

Original Page 516

10. Federal Government Specialized Service or Arrangements (Cont'd)

10.8 Service Offerings (Cont'd)

10.8.1 Type and Description (Cont'd)

(C) Special Routing Access Service (Cont'd)

This service is an optional service which operates in conjunction with Trunk Side Premium Access Service furnished to an IC under provisions of this tariff.

The Telephone Company will record Special Routing Access Service Active Mode Trunk Usage, and will bill the customer in accordance with these records. The hours for each trunk ordered will be summed and then rounded to the nearest hour, except that when the total is less than one hour, one hour will be used to determine the charge.)

(D) Telecommunications Service Priority (TSP) System

The TSP System is a service, developed to meet the requirements of the Federal Government, which provides the regulatory, administrative and operational framework for the priority installation and/or restoration of National Security Emergency Preparedness (NSEP) telecommunications services. Priority installation and/or restoration of NSEP telecommunications services shall be provided in accordance with Part 64.401, Appendix A, of the Federal Communications Commission's (FCC's) Rules and Regulations.

In addition, TSP System service shall be provided in accordance with the guidelines set forth in "Telecommunications Service Priority (TSP) System for National Security Emergency Preparedness (NSEP) Service Vendor Handbook" (NCS) H 3-1-2 dated July 9, 1990, and "Telecommunications Service Priority (TSP) System for National Security Emergency Preparedness (NSEP) Service User Manual" (NCS) H 3-1-1.

Regulations, rates and charges are as specified in the Telephone Company's Tariff No. 35, Access Service, Section 10.

PUBLIC SERVICE COMMISSION  
OF KENTUCKY  
EFFECTIVE

MAR 3 1992

Issued: February 7, 1992

*Robert E. Sigmon*

for

President, Cincinnati, Ohio

EFFECTIVE: ~~February 15, 1992~~ <sup>March 3, 1992</sup>  
SUBJECT: ~~MD 807 KAR 501.1~~  
SECTION 9 (1)

BY: *Shirley Belle*  
PUBLIC SERVICE COMMISSION MANAGER

Vice President - Regulatory Affairs

ACCESS SERVICE TARIFF  
 PSCK No. 2

CINCINNATI BELL TELEPHONE COMPANY

Original Page 517

10. Federal Government Specialized Service or Arrangements (Cont'd)

10.8 Service Offerings (Cont'd)

10.8.2 Rates and Charges

(A) Voice Grade Special Access Service

The provision of T-3 and G conditioned services contemplates station and tandem switching operations, using customer provided equipment, as well as Special Access Service. Separate narrowband or voice grade services, where required by the customer provided equipment or switching operation, are furnished in accordance with the applicable sections of this tariff.

| <u>Voice Grade Secure Communications</u>            | <u>USOC</u> | <u>Monthly Rates</u> | <u>Nonrecurring Charges</u> | <u>Termination Charges</u> |
|---|-------------|----------------------|-----------------------------|----------------------------|
| Type I, each<br>T-3 Conditioning,                   | GCA++       | *                    | *                           | *                          |
| Additional Conditioning,<br>per service termination | GTO++       | *                    | *                           | *                          |
| Type II, each<br>G-1 Conditioning,                  | GCB++       | *                    | *                           | *                          |
| Type III, each<br>G-2 Conditioning,                 | GCC++       | *                    | *                           | *                          |
| Additional Conditioning,<br>per service termination | G20++       | *                    | *                           | *                          |

PUBLIC SERVICE COMMISSION  
 OF KENTUCKY  
 EFFECTIVE

MAR 3 1992

\* Charges equivalent to the estimated cost to be incurred.

PURSUANT TO 807 KAR 5:011,  
 SECTION 9 (1)

Issued: February 7, 1992

Effective: March 3, 1992  
 PUBLIC SERVICE COMMISSION MANAGER

*Robert E. Aigmon* for President, Cincinnati, Ohio

Vice President - Regulatory Affairs

ACCESS SERVICE TARIFF  
PSCK No. 2

CINCINNATI BELL TELEPHONE COMPANY

Original Page 518

10. Federal Government Specialized Service or Arrangements (Cont'd)

10.8 Service Offerings (Cont'd)

10.8.2 Rates and Charges (Cont'd)

(A) Voice Grade Special Access Service (Cont'd)

| <u>Voice Grade Secure Communications</u>                   | <u>USOC</u> | <u>Monthly Nonrecurring Termination</u> |                |                |
|--|-------------|---|----------------|----------------|
|  |             | <u>Rates</u>                            | <u>Charges</u> | <u>Charges</u> |
| Type IV, each<br>G-3 Conditioning,                         | GCD++       | *                                       | *              | *              |
| Additional,<br>Conditioning,<br>per service<br>termination | G30++       | *                                       | *              | *              |

(B) Wideband Digital Special Access Service

| <u>Wideband Secure Communications</u> | <u>USOC</u> | <u>Monthly Nonrecurring Termination</u> |                |                |
|---------------------------------------|-------------|---|----------------|----------------|
|                                       |             | <u>Rates</u>                            | <u>Charges</u> | <u>Charges</u> |
| Type I, each                          | GW1++       | *                                       | *              | *              |
| Type II, each                         | GW2++       | *                                       | *              | *              |
| Type III, each                        | GW3++       | *                                       | *              | *              |

(C) Special Routing Access Service

The following rates and charges are in addition to all other rates and charges that may be applicable for other services that may be furnished under the provisions of this tariff to operate in conjunction with this service:

|   | <u>USOC</u> | <u>Rates</u> | <u>Nonrecurring Charges</u> |
|---|-------------|--------------|-----------------------------|
| (1) Special Routing Access Service Special Routing Plan Setup, per Switching System | G1B         | -            | \$288.45                    |

PUBLIC SERVICE COMMISSION  
OF KENTUCKY  
EFFECTIVE  
MAR 3 1992

\* Charges equivalent to the estimated cost to be incurred.

Issued: February 7, 1992  
*Robert E. Aigmon* for  
President, Cincinnati, Ohio

PURSUANT TO 807 KAR 5:011.  
SECTION 9 (1)  
Effective: March 3, 1992  
BY: *[Signature]*  
PUBLIC SERVICE COMMISSION

Vice President - Regulatory Affairs

ACCESS SERVICE TARIFF  
 PSCK No. 2

CINCINNATI BELL TELEPHONE COMPANY

Original Page 519

10. Federal Government Specialized Service or Arrangements (Cont'd)

10.8 Service Offerings (Cont'd)

10.8.2 Rates and Charges (Cont'd)

(C) Special Routing Access Service (Cont'd)

|   | <u>USOC</u> | <u>Rates</u> | <u>Nonrecurring<br/>Charges</u>                               |
|---|-------------|--------------|---|
| (2) Special Routing<br>Access Service<br>Trunk Group Setup,<br>per End Office or<br>Tandem Office<br>Switching Systems,<br>per occurrence |             |              |   |
| - Telephone Company<br>Selection  | G1D         | -            | \$442.15  |
| - Customer Selection  | G1S++       |              | Charges equivalent to<br>the estimated cost to<br>be incurred |
| (3) Special Routing<br>Access Service<br>Mode Selection<br>(Active or<br>Deactive),<br>per Switching<br>System, per<br>occurrence         | G1E         | -            | 73.46   |
| (4) Special Routing<br>Access Service<br>Trunk Usage, when<br>in an active mode,<br>per trunk, per hour                                   | G1T         | \$0.54*      | -   |

**PUBLIC SERVICE COMMISSION  
 OF KENTUCKY  
 EFFECTIVE**

\* This rate is in addition to Trunk Side Premium Access Service rates, as set forth in 6. preceding, that apply on an ongoing basis regardless of the mode selected as set forth in (3) preceding.

MAR 3 1992

**PURSUANT TO 807 KAR 5-011,**

Effective **SECTION 9 (3)**, March 3, 1992

BY: Handwritten Signature  
 PUBLIC SERVICE COMMISSION

Issued: February 7, 1992

Robert E. Dignon for

President, Cincinnati, Ohio

Vice President - Regulatory Affairs

ACCESS SERVICE TARIFF  
PSC No. 2

CINCINNATI BELL TELEPHONE COMPANY

Original Page 520

10. Federal Government Specialized Service or Arrangements (Cont'd)

10.8 Service Offerings (Cont'd)

10.8.2 Rates and Charges (Cont'd)

(C) Special Routing Access Service (Cont'd)

|  | <u>USOC</u> | <u>Rates</u> | <u>Nonrecurring<br/>Charges</u> |
|--|-------------|--------------|---------------------------------|
| (5) Special Routing Access<br>Service Maintenance<br>and Administration,<br>per Switching<br>System, per month | G1M         | \$144.75     | -                               |

PUBLIC SERVICE COMMISSION  
OF KENTUCKY  
EFFECTIVE

MAR 3 1992

PURSUANT TO 807 KAR 5:011,  
SECTION 9 (1)

BY:   
Effective: ~~March 3, 1992~~  
PUBLIC SERVICE COMMISSION MANAGER

Issued: February 7, 1992

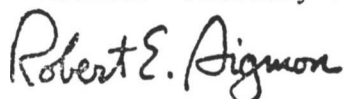
 for President, Cincinnati, Ohio

Vice President - Regulatory Affairs



11. Special Facilities Routing of Access Services

11.1 Description of Special Facilities Routing of Access Services

The services provided under this tariff are provided over such routes and facilities as the Telephone Company may elect. Special Facilities Routing is involved when, in order to comply with requirements specified by the customer, the Telephone Company provides Switched Access Service, Special Access Service or Federal Government Specialized Service or Arrangements in a manner which includes one or more of the following conditions:

11.1.1 Diversity

Two or more services, or portions thereof, must be provided over not more than two different routes, e.g., physical geographical routes, separate cable sheaths, different carrier transmission systems, different microwave systems, etc.

11.1.2 Avoidance

A service must be provided on a route which avoids specified geographical locations.

11.1.3 Cable-Only Facilities

Certain Voice Grade services are provided on Cable-Only Facilities to meet the particular needs of a customer.

Service is provided subject to the availability of Cable-Only facilities. In the event of service failure, restoration will be made through the use of any available facilities as selected by the Telephone Company.

Avoidance and Diversity are available on Switched Access Service as set forth in 6. preceding, Special Access Services as set forth in 7. preceding and Federal Government Specialized Service or Arrangements as set forth in 10.8 preceding. Cable-Only Facilities are available for Switched Access Service as set forth in 6. preceding; Voice Grade Special Access Services as set forth in 7.2.3 preceding and Federal Government Specialized Service or Arrangements as set forth in 10.8 preceding.

**PUBLIC SERVICE COMMISSION  
OF KENTUCKY  
EFFECTIVE**

MAR 3 1992

**PURSUANT TO 807 KAR 5:011,**

Issued: February 7, 1992

Effective: <sup>SECTION 911</sup> March 31, 1992

*Robert E. Aigmon* for

President, Cincinnati, Ohio

BY: *Sharon Keller*  
PUBLIC SERVICE COMMISSION

**Vice President - Regulatory Affairs**

ACCESS SERVICE TARIFF  
PSCK No. 2

CINCINNATI BELL TELEPHONE COMPANY

Original Page 522

11. Special Facilities Routing of Access Services (Cont'd)

11.1 Description of Special Facilities Routing of Access Services (Cont'd)

In order to avoid the compromise of special routing information, the Telephone Company will provide the required routing information for each specially routed service to only the ordering customer. If requested by the customer, this information will be provided when service is installed and prior to any subsequent changes in routing.

The offering of Special Facilities Routing of Access Services contemplates the use of existing facilities. Should facilities not be available, it may be necessary to construct such facilities, either as (1) normal or (2) Special Construction. If Special Construction is involved, the applicable rates and charges are equivalent to the estimated cost to be incurred.

The rates and charges for Special Facilities Routing of Access Services as set forth in 11.2 following are in addition to all other rates and charges that may be applicable for services provided under other sections of this tariff.

11.2 Rates and Charges for Special Facilities Routing of Access Service

The rates and charges for Special Facilities Routing of Access Services are as follows:

11.2.1 Diversity

For each service provided in accordance with 11.1.1 preceding, the rates and charges will be equivalent to the estimated cost to be incurred:

USOC

SYD++

**PUBLIC SERVICE COMMISSION  
OF KENTUCKY  
EFFECTIVE**

MAR 3 1992

**PURSUANT TO 807 KAR 5:011,  
SECTION 9 (1)**

BY: [Signature]  
PUBLIC SERVICE COMMISSION MANAGER

Issued: February 7, 1992

Effective: March 3, 1992

Robert E. Aigmon for

President, Cincinnati, Ohio

Vice President - Regulatory Affairs

ACCESS SERVICE TARIFF  
PSCK No. 2

CINCINNATI BELL TELEPHONE COMPANY

Original Page 523

11. Special Facilities Routing of Access Services (Cont'd)

11.2 Rates and Charges for Special Facilities Routing of Access Service  
(Cont'd)

11.2.2 Avoidance

For each service provided in accordance with 11.1.2 preceding, the rates and charges will be equivalent to the estimated cost to be incurred:

USOC

SYA++

11.2.3 Diversity and Avoidance Combined

For each service provided in accordance with 11.1.1 and 11.1.2 preceding, combined, the rates and charges will be equivalent to the estimated cost to be incurred:

USOC

SYB++

11.2.4 Cable-Only Facilities

For each service provided in accordance with 11.1.3 preceding, the rates and charges will be equivalent to the estimated cost to be incurred:

USOC

SYC++

PUBLIC SERVICE COMMISSION  
OF KENTUCKY  
EFFECTIVE

MAR 3 1992

PURSUANT TO 807 KAR 5:011,  
SECTION 9 (1)

BY: [Signature]  
PUBLIC SERVICE COMMISSION MANAGER

Issued: February 7, 1992

Effective: March 3, 1992

Robert E. Aigmon for

President, Cincinnati, Ohio

**Vice President - Regulatory Affairs**

ACCESS SERVICE TARIFF  
PSCK No. 2

CINCINNATI BELL TELEPHONE COMPANY

1st Revised Page 524  
Cancels Original Page 524

12. Specialized Service Or Arrangements

12.1 General

Specialized Service or Arrangements may be provided by the Telephone Company, at the request of a customer, on an individual case basis if such service or arrangements meet the following criteria:

- (A) The requested service or arrangements are not offered under other sections of this tariff.
- (B) The facilities utilized to provide the requested service or arrangements are of a type normally used by the Telephone Company in furnishing its other services.
- (C) The requested service or arrangements are provided within a LATA.
- (D) The requested service or arrangements are compatible with other Telephone Company services, facilities, and its engineering and maintenance practices.
- (E) This offering is subject to the availability of the necessary Telephone Company personnel and capital resources.

12.2 Move Charges

- (A) When service without a maximum termination liability charge associated with it is moved to new location within the same building or to a different building, all associated **nonrecurring** charges will apply.

(C)  
|  
(C)

PUBLIC SERVICE COMMISSION  
OF KENTUCKY  
EFFECTIVE

MAY 23 1995

PURSUANT TO 807 KAR 5.011,  
SECTION 9 (1)

BY: Jordan C. Neel  
FOR THE PUBLIC SERVICE COMMISSION

Issued June 13, 1995

*Deborah L. Neesh*

Vice President  
Integrated Corporate Planning for

President, Cincinnati, Ohio

Effective: **May 23, 1995**

12. Specialized Service Or Arrangements (Cont'd)

12.2 Move Charges (Cont'd)

(B) When service with a maximum termination liability charge associated with it is moved and is reinstalled at a new location, the customer may elect:

- to pay the unexpired portion of the maximum termination liability charge for the service, if any, with the application of a nonrecurring charge and the establishment of a new maximum termination liability charge for such service at the new location, or
- to continue service subject to the unexpired portion of the maximum termination liability charge, if any, and pay the estimated costs of moving such service, provided that the customer requests these charges be quoted prior to ordering the service move. Charges for moving such service will be based on estimated costs attributable to the move.

Move charges include the estimated costs of removal, restoration of service or facilities necessitated by the move, transportation, storage, reinstallation, engineering, labor, supervision, materials, administration, and any other specific items of cost directly attributable to the move.

12.3 Simplified Message Desk Interface (SMDI)

12.3.1 Description of Service

SMDI is a feature provided from certain Telephone Company central offices primarily for the use of customers who provide an answering bureau service or voice messaging service for their clients. When used in conjunction with an appropriate configuration of Call Forwarding capability on client lines, Message Waiting Indicator capability on client lines, multi-line hunt groups, and Voice Grade Special Access Channels, it will provide the following:

- (A) For a call to a client line which has been forwarded via Call Forwarding to the customer's multi-line hunt group, the following information and functions will be provided to the customer:

PUBLIC SERVICE COMMISSION  
OF KENTUCKY  
EFFECTIVE

MAR 3 1992

PURSUANT TO 807 KAR 5:011,

SECTION 9 (1)

Issued: February 7, 1992

Effective: March 3, 1992

*Robert E. Aigmon*

for

President, Cincinnati, Ohio

BY: *[Signature]*  
PUBLIC SERVICE COMMISSION

Vice President - Regulatory Affairs

12. Specialized Service or Arrangements (Cont'd)

12.3 Simplified Message Desk Interface (SMDI) (Cont'd)

12.3.1 Description of Service (Cont'd)

(A) (Cont'd)

- identification of the client's number which was called.
- identification of the call originator's number when the call originates in the same central office that serves the customer.
- reason the call is being forwarded, i.e.,  
    busy,  
    not answered,  
    either busy or not answered.
- identification of the customer line in the multi-line hunt group which is receiving the call.
- ability for the customer to activate the Message Waiting Indicator feature on the associated client line.

(B) For a direct dialed call to the customer's multi-line hunt group the following information will be provided to the customer:

- identification of the call originator's number when the call originates in the same central office that serves the customer.
- indication that the call is a direct dialed call.
- identification of the customer line in the multiline hunt group which is receiving the call.

(C) SMDI data is transmitted over a Voice Grade Special Access Channel between a Telephone Company equipped SMDI central office and the customer's premises at a speed of 1200 baud.

12.3.2 Regulations

(A) Call Forwarding and Message Waiting Indicator are furnished in accordance with the provisions set forth in the Telephone Company's General Exchange Tariff PSCK No. 3.

(B) Multi-line hunt groups may be comprised of FGA Lines equipped with the multi-line hunt group optional feature as provided for in 6. preceding or any compatible non-dependence line side service offered in one of the Telephone Company's intrastate tariffs.

PURSUANT TO 807 KAR 5:011,  
SECTION 9(1)

Issued: February 7, 1992

Effective: 3-1-1992  
PUBLIC SERVICE COMMISSION  
OF KENTUCKY  
NAC

*Robert E. Aigmon* for President, Cincinnati, Ohio

Vice President - Regulatory Affairs

12. Specialized Service or Arrangements (Cont'd)

12.3 Simplified Message Desk Interface (SMDI) (Cont'd)

12.3.2 Regulations (Cont'd)

- (C) Voice Grade Special Access Channels serve as a data link between the Telephone Company's central office and the customer's premises and are furnished in accordance with the provisions set forth in 7. preceding.
- (D) A multi-line hunt group and Voice Grade Special Access Channel are required for each central office from which the customer elects to provide its answering bureau service or voice message service to clients located in such central office areas.
- (E) The customer must provide compatible modems for the transmission of data and a controller device to interface with the Voice Grade Special Access Channel which carries the calling information. The modems and controller device must comply with Bellcore Technical Reference TR-TSY-000283.
- (F) SMDI is offered from selected central offices where the Telephone Company has arranged the facilities for the service and is furnished subject to the availability of facilities.
- (G) SMDI will be furnished only when the customer contracts for an amount of access lines as may be required in the judgement of the Telephone Company to adequately carry its calling volume so as not to impair the service of other Telephone Company customers.
- (H) In case of an interruption to SMDI service, allowance for the period of interruption, if not due to the negligence of the customer, shall be a credit for each period of 24 hours or major fraction thereof (i.e., 12 plus hours) that the interruption continues. The credit shall be at the rate of 1/30 of the monthly rate for each such period. Other applicable regulations are specified in 2.4.4 preceding.

PUBLIC SERVICE COMMISSION  
OF KENTUCKY  
EFFECTIVE

MAR 3 1992

PURSUANT TO 807 KAR 5:011,  
SECTION 9(1)

Issued: February 7, 1992

Effective: March 3, 1992  
PUBLIC SERVICE COMMISSION MANAGER

*Robert E. Aigmon* for President, Cincinnati, Ohio

Vice President - Regulatory Affairs

ACCESS SERVICE TARIFF  
PSCK NO. 2

CINCINNATI BELL TELEPHONE COMPANY

Original Page 528

12. Specialized Service or Arrangements (Cont'd)

12.3 Simplified Message Desk Interface (SMDI) (Cont'd)

12.3.3 Rates

|                                 | <u>USOC</u> | <u>Monthly<br/>Rate</u> | <u>Nonrecurring<br/>Charge</u> |
|---------------------------------|-------------|-------------------------|--------------------------------|
| SMDI Feature<br>- per data link | SME         | \$525.00                | \$4,500.00                     |

PUBLIC SERVICE COMMISSION  
OF KENTUCKY  
EFFECTIVE

MAR 3 1992

PURSUANT TO 807 KAR 5:011,  
SECTION 9(1)

BY: Sharon Deller  
PUBLIC SERVICE COMMISSION ANAC

Issued: February 7, 1992

Effective: March 3, 1992

Robert E. Aigmon for President, Cincinnati, Ohio

Vice President - Regulatory Affairs



ACCESS SERVICE TARIFF  
PSCK No. 2

CINCINNATI BELL TELEPHONE COMPANY

2nd Revised Page 529  
Cancels 1st Revised Page 529

13. Additional Ennineerinn. Additional Labor and Miscellaneous Services

In this section normally scheduled working hours are an employee's scheduled work period in any given calendar day (e.g., 7:00 a.m. to 4:00 p.m.) for the application of rates based on working hours.

13.1 Additional Engineering

Additional Engineering will be provided by the Telephone Company at the request of the customer only when:

- (A) A customer requests additional technical information after the Telephone Company has already provided the technical information normally included on the Design Layout Report (DLR) as set forth in 6.1.5 and 7.1.6 preceding.
- (B) Additional engineering time is incurred by the Telephone Company to engineer a customer's request for a customized service as set forth in 7.2.1 preceding.

The Telephone Company will notify the customer that additional engineering charges, as set forth in 13.1.1 following, will apply before any additional engineering is undertaken.

13.1.1 Charges For Additional Engineering

The charges for additional Engineering are as follows:

| <u>Additional Engineering<br/>Periods</u>               | <u>USOC</u> | <u>First Half<br/>Hour or<br/>Fraction<br/>Thereof</u> | <u>Each Additional<br/>Half Hour or<br/>Fraction<br/>Thereof</u> |
|---|-------------|--|--|
| (A) Basic Time,<br>normally scheduled<br>working hours# | AEH         | \$66.03(I)   | \$54.47(I)   |

# If more than one engineer is involved with the same additional engineering project, the total amount of time for all engineers involved will be aggregated prior to the distribution of time between the "First Half Hour or Fraction Thereof" and "Each Additional Half Hour or Fraction Thereof" rate categories.

MAY 23 1995

PURSUANT TO 807 KAR 5.011,  
SECTION 9 (1)

BY: Jordan C. Neal  
FOR THE PUBLIC SERVICE COMMISSION

Issued: June 23, 1995

Effective: May 23, 1995

*Deborah Hesch*

President, Cincinnati, Ohio

Vice President  
Integrated Corporate Planning for

ACCESS SERVICE TARIFF  
PSCK No. 2

CINCINNATI BELL TELEPHONE COMPANY

2nd Revised Page 530  
Cancels 1st Revised Page 530

13. Additional Engineering, Additional Labor and Miscellaneous Services (Cont'd)

13.1 Additional Engineering (Cont'd)

13.1.1 Charges for Additional Engineering (Cont'd)  
PUBLIC SERVICE COMMISSION  
OF KENTUCKY  
EFFECTIVE

MAY 23 1995

Additional Engineering  
Periods

USOC

First Half Hour or Fraction Thereof    Each Additional Half Hour or Fraction Thereof

PURSUANT TO 837 KAR 501,

(B) Overtime,  
outside of normally  
scheduled working  
hours#

AEH

\$66.03(I)    \$54.47(I)

SECTION 9 (I)

BY: Jordan G. Neal  
FOR THE PUBLIC SERVICE COMMISSION

13.2 Additional Labor

Additional labor is that labor requested by the customer on a given service and agreed to by the Telephone Company as set forth in 13.2.1 through 13.2.5 following. The Telephone company will notify the customer that additional labor charges as set forth in 13.2.6 following will apply before any additional labor is undertaken.

13.2.1 Overtime Installation

Overtime installation is that Telephone Company installation effort outside of normally scheduled working hours.

13.2.2 Overtime Repair

Overtime repair is that Telephone Company maintenance effort performed outside of normally scheduled working hours.

13.2.3 Stand by

Stand by includes all time in excess of one-half (1/2) hour during which Telephone Company personnel stand by to make cooperative tests with a customer to verify facility repair on a given service.

# If more than one engineer is involved with the same additional engineering project, the total amount of time for all engineers involved will be aggregated prior to the distribution of time between the "First Half Hour or Fraction Thereof" and "Each Additional Half Hour or Fraction Thereof" rate categories.

Issued: June 13, 1995

Effective: May 23, 1995

*Deborah A. Nisch*

President, Cincinnati, Ohio

Vice President  
Integrated Corporate Planning for

ACCESS SERVICE TARIFF  
PSCK No. 2

CINCINNATI BELL TELEPHONE COMPANY

2nd Revised Page 531  
Cancels 1st Revised Page 531

13. Additional Engineering, Additional Labor and Miscellaneous Services (Cont'd)

13.2 Additional Labor (Cont'd)

13.2.4 Testing and Maintenance with Other Telephone Companies

Testing and Maintenance with Other Telephone Companies is that additional testing, maintenance or repair of facilities which connect to facilities of other telephone companies, which is in addition to normal effort required to test, maintain or repair facilities provided solely by the Telephone company,

13.2.5 Other Labor

Other labor is that additional labor not included in 13.2.1 through 13.2.4 preceding and labor incurred to accommodate a specific customer request that involves only labor which is not covered by any other section of this tariff.

13.2.6 Charges For Additional Labor

The charges for additional labor are as follows:

| PUBLIC SERVICE COMMISSION<br>OF KENTUCKY<br>EFFECTIVE | Additional Labor<br><u>Periods</u>   | USOC   | First Half                     | Each Additional                     |
|---|--|--------|--------------------------------|-------------------------------------|
|   |  |        | Hour or<br>Fraction<br>Thereof | Half Hour or<br>Fraction<br>Thereof |
|   | (A) Installation or Repair   |        |                                |                                     |
|   | - Overtime,<br>outside of normally<br>scheduled working<br>hours on a scheduled<br>work day# | ALH(Z) | \$26.58*(I)                    | \$15.02*(I)                         |
|   | - Premium Time,<br>outside of scheduled<br>work day#   | ALH    | 41.58*(I)                      | 30.02*(I)                           |

# If more than one technician is involved with the same additional labor project, the total amount of time for all technicians involved will be aggregated prior to the distribution of time between the "First Half Hour or Fraction Thereof" and "Each Additional Half Hour or Fraction Thereof" rate categories.

\* A call-out of a Telephone Company employee at a time not consecutive with the employee's scheduled work period is subject to a minimum charge of four hours.

Issued: June 13, 1995

Effective: May 23, 1995

*Deborah A. Nisch*  
Vice President  
Integrated Corporate Planning for

President, Cincinnati, Ohio

ACCESS SERVICE TARIFF  
PSCK No. 2

CINCINNATI BELL TELEPHONE COMPANY

2nd Revised Page 532  
Cancels 1st Revised Page 532

13. Additional Engineering, Additional Labor and Miscellaneous Services (Cont'd)

13.2 Additional Labor (Cont'd)

13.2.6 Charges For Additional Labor (Cont'd)

| Additional Labor<br>Periods  | USOC   | First Half                     | First   | Each  |             |
|--|--|--------------------------------|---|---|-------------|
|  |  | Hour or<br>Fraction<br>Thereof | Billable<br>Half Hour<br>or Fraction<br>Thereof | Additional<br>Half Hour<br>or Fraction<br>Thereof |             |
| (B) Stand by   |  |                                |   |   |             |
| PUBLIC SERVICE COMMISSION<br>OF KENTUCKY<br>EFFECTIVE<br>MAY 23 1995<br>PURSUANT TO 807 KAR 5011,<br>SECTION 9 (1)<br>BY: <u>Jordan C. Neal</u><br>FOR THE PUBLIC SERVICE COMMISSION | - Basic time,<br>normally scheduled<br>working hours#  | ALT                            | None  | \$41.58 (I)                                       | \$30.02 (I) |
|  | - Overtime,<br>outside of normally<br>scheduled working<br>hours on a scheduled<br>work day# | ALT                            | None  | 56.60*(I)   | 45.04*(I)   |
|  | - Premium Time,<br>outside of scheduled<br>work day#   | ALT                            | None  | 71.61*(I)   | 60.05*(I)   |

# If more than one technician is involved with the same additional labor project, the total amount of time for all technicians involved will be aggregated prior to the distribution of time between the "First Billable Half Hour or Fraction Thereof" and "Each Additional Half Hour or Fraction Thereof" rate categories.

\* A call-out of a Telephone Company employee at a time not consecutive with the employee's scheduled work period is subject to a minimum charge of four hours.

Issued: June 13, 1995

Effective: May 23, 1995

*Deborah A. Nisch*

President, Cincinnati, Ohio

Vice President  
Integrated Corporate Planning for

ACCESS SERVICE TARIFF  
PSCK No. 2

CINCINNATI BELL TELEPHONE COMPANY

2nd Revised Page 533  
Cancels 1st Revised Page 533

13. Additional Engineering, Additional Labor and Miscellaneous Services (Cont'd)

13.2 Additional Labor (Cont'd)

13.2.6 Charges For Additional Labor (Cont'd)

The charges for additional labor are as follows:

| <u>Additional Labor<br/>Periods</u>  | <u>USOC</u> | <u>First Half<br/>Hour or<br/>Fraction<br/>Thereof</u> | <u>Each Additional<br/>Half Hour<br/>or Fraction<br/>Thereof</u> |
|--|-------------|--|--|
| (C) Testing and<br>Maintenance with other<br>telephone companies,<br>or Other Labor          |             |  |  |
| - Basic time,<br>normally scheduled<br>working hours#  | ALK         | \$41.58 (I)  | \$30.02 (I)  |
| - Overtime,<br>outside of normally<br>scheduled working hours<br>on a scheduled<br>work day# | ALK         | 56.60*(I)  | 45.04*(I)  |
| - Premium Time,<br>outside of scheduled<br>work day#   | ALK         | 71.61*(I)  | 60.05*(I)  |

PUBLIC SERVICE COMMISSION  
OF KENTUCKY  
EFFECTIVE

MAY 23 1995

PURSUANT TO 807 KAR 5.011,  
SECTION 9(1)

BY: Jordan C. Neel  
FOR THE PUBLIC SERVICE COMMISSION

# If more than one technician is involved with the same additional labor project, the total amount of time for all technicians involved will be aggregated prior to the distribution of time between the "First Half Hour or Fraction Thereof" and "Each Additional Half Hour or Fraction Thereof" rate categories.

\* A call-out of a Telephone Company employee at a time not consecutive with the employee's scheduled work period is subject to a minimum charge of four hours.

Issued: June 13, 1995

Effective: May 23, 1995

President, Cincinnati, Ohio

*Deborah A. Nisch*

Vice President  
Integrated Corporate Planning for

ACCESS SERVICE TARIFF  
PSC No. 2

CINCINNATI BELL TELEPHONE COMPANY

2nd Revised Page 534  
Cancels 1st Revised Page 534

13. Additional Engineering, Additional Labor and Miscellaneous Services (Cont'd)

13.3 Miscellaneous Services

13.3.1 Maintenance of Service

(A) When a customer reports a trouble to the Telephone Company for clearance and no trouble is found in the Telephone Company's facilities, the customer shall be responsible for payment of a Maintenance of Service charge for the period of time from when Telephone Company personnel are dispatched to when the work is completed. Failure of Telephone Company personnel to find trouble in Telephone Company facilities will result in no charge if the trouble is actually in those facilities, but not discovered at the time.

PUBLIC SERVICE COMMISSION  
OF KENTUCKY  
EFFECTIVE

(B) The customer shall be responsible for payment of a Maintenance of Service charge when the Telephone Company dispatches personnel and the trouble is in equipment or communications systems provided by other than the Telephone Company or in detariffed CPE provided by the Telephone Company.

MAY 23 1995

PURSUANT TO 807 KAR 5.011,  
SECTION 9(1)

BY: Jordan C. Neal  
FOR THE PUBLIC SERVICE COMMISSION

In either (A) or (B) preceding, no credit allowance will be applicable for the interruption involved if the Maintenance of Service charge applies.

(C) The charges for Maintenance of Service are as follows:

| <u>Maintenance of Service</u><br><u>Periods</u>       | <u>USOC</u> | <u>First Half</u><br><u>Hour or</u><br><u>Fraction</u><br><u>Thereof</u> | <u>Each Additional</u><br><u>Half Hour</u><br><u>or Fraction</u><br><u>Thereof</u> |
|---|-------------|--|--|
| - Basic time,<br>normally scheduled<br>working hours# | MVV         | \$41.58 (I)  | \$30.02 (I)  |

# If more than one technician is involved with the same trouble report, the total amount of time for all technicians dispatched involved will be aggregated prior to the distribution of time between the "First Half Hour or Fraction Thereof" and "Each Additional Half Hour or Fraction Thereof" rate categories.

Issued: June 13, 1995  
Deborah A. Nisch  
Vice President  
Integrated Corporate Planning for

Effective: May 23, 1995

President, Cincinnati, Ohio

ACCESS SERVICE TARIFF  
PSCK No. 2

CINCINNATI BELL TELEPHONE COMPANY

2nd Revised Page 535  
Cancels 1st Revised Page 535

13. Additional Engineering, Additional Labor and Miscellaneous Services (Cont'd)

13.3 Miscellaneous Services (Cont'd)

13.3.1 Maintenance of Service (Cont'd)

(C) (Cont'd)

| Maintenance of Service<br>Periods  | USOC | First Half<br>Hour or<br>Fraction<br>Thereof | Each Additional<br>Half Hour<br>or Fraction<br>Thereof |
|--|------|--|--|
| - Overtime,<br>outside of normally<br>scheduled working hours<br>on a scheduled<br>work day# | MVV  | \$56.60*(I)                                  | \$45.04*(I)  |
| - Premium Time<br>outside of scheduled<br>work day#  | MVV  | 71.61*(I)                                    | 60.05*(I)  |

PUBLIC SERVICE COMMISSION  
OF KENTUCKY  
EFFECTIVE

MAY 23 1995

PURSUANT TO 807 KAR 5.011,  
SECTION 9(1)

BY: Jordan C. Neal  
FOR THE PUBLIC SERVICE COMMISSION

# If more than one technician is involved with the same trouble report, the total amount of time for all technicians dispatched involved will be aggregated prior to the distribution of time between the "First Half Hour or Fraction Thereof" and "Each Additional Half Hour or Fraction Thereof" rate categories.

\* A call-out of a Telephone Company employee at a time not consecutive with the employee's scheduled work period is subject to a minimum charge of four hours.

Issued: June 19, 1995

Effective: **May 23, 1995**

*Deborah A. Neish*  
Vice Resident                      President, Cincinnati, Ohio  
Integrated Corporate Planning for

13. Additional Engineering, Additional Labor and Miscellaneous Services (Cont'd)

13.3 Miscellaneous Services (Cont'd)

13.3.2 Restoration Priority

Existing Restoration Priority (RP) was superceded by Telecommunications Service Priority (TSP), as specified in 10 8 1(D) preceeding, on September 10, 1990 Existing RP arrangements for Special Access Services will remain in effect for thirty (30) months until March 10, 1993 If RP is converted to TSP, the customer will incur the Priority Restoration Level Implementation Nonrecurring Charge as specified in 10 8 2(D)(2)(a) preceding

13.3.3 Carrier Toll Restriction Services

Carrier Toll Restriction Services are central office switch based service arrangements designed to provide selective toll blocking service to toll service providers on a non-discriminatory basis. This service is designed to be used by all toll service providers, including the Telephone Company, when they disconnect their own toll service customers for nonpayment of toll service charges and when they disconnect accounts for which they have purchased accounts receivable or have billing and collection contracts for the non-payment of toll services.

The toll service provider is the customer for this service and will be billed the charges specified below when the service is activated. After subscribing to this service, the toll provider provides the Telephone Company with a list of end user customers who should be denied access to the toll provider's facilities and a list of previously denied end-users who should regain access. See note below.

PUBLIC SERVICE COMMISSION  
OF KENTUCKY  
EFFECTIVE

OCT 04 1998

PURSUANT TO 307 KAR 5.011,  
SECTION 9 (1)

BY: Stephen D. Bell  
SECRETARY OF THE COMMISSION

A Selective Carrier Denial

Selective Carrier Denial is a Carrier Toll Restriction Service which limits the end user's access to the requesting toll service provider's facilities. The service selectively restricts 1+, 10XXX and 0+ toll calling on a toll service provider basis. However, the service does not restrict access to the operator by dialing 0- and, therefore, cannot prevent calls placed through an operator.

Note 1: The Telephone Company may initiate the Carrier Toll Restriction Service on behalf of the toll service provider subject to the Billing and Collection contracts that exist between the Telephone Company and the toll service provider.



13. Additional Engineering, Additional Labor and Miscellaneous Services (Cont'd)

13.3 Miscellaneous Services (Cont'd)

13.3.3 Carrier Toll Restriction Services (Cont'd)

B. DePICing Service

DePICing is an optional method of providing Carrier Toll Restriction Service. The DePICing Service is a form of toll disconnection which allow the toll provider to disconnect 1+ toll access to its own presubscribed customers who do not pay their toll service bills. This service forces the nonpaying presubscribed customer's access to that toll provider to be on a 10XXX and/or 0- basis. This service only affects access to the requesting toll provider's service.

(N)

This service may be requested by the toll service provider or it may be provided on the initiative of the Telephone Company but with the approval of the toll service provider. This service will generally be provided only where it is not technically feasible to provide Selective Carrier Denial Service.

C. Regulations

- (1) The Telephone Company will provide Carrier Toll Restriction Services, on a nondiscriminatory basis, to all toll service providers in service areas where implementation of intralATA equal access has occurred.
- (2) Carrier Toll Restriction Services are offered subject to the availability of suitable facilities and are limited to central offices specifically equipped to provide the services.
- (3) The Telephone Company shall not be liable to the toll service provider or to any other person or entity for damages of any nature or kind arising out of, resulting from, or in connection with the provision of Carrier Toll Restriction Service including without limitation, the inability to access the operator or any non-toll free number for any purpose.
- (4) Carrier Toll Restriction Services do not provide restriction of non-chargeable calls to numbers such as repair service, public emergency service (i.e., 911), 1+800 calling, and 1+ 888 calling, or local directory assistance (DA) service.

(N)

PUBLIC SERVICE COMMISSION  
OF KENTUCKY  
EFFECTIVE

OCT 04 1998

PURSUANT TO 807 KAR 5.011,  
SECTION 9 (1)

BY: Shirley Bell  
SECRETARY OF THE COMMISSION

13. Additional Engineering, Additional Labor and Miscellaneous Services (Cont'd)

13.3 Miscellaneous Services (Cont'd)

13.3.3 Carrier Toll Restriction Services (Cont'd)

C. Regulations (Cont'd)

Carrier Toll Restriction Services will be provided to Residence One-Party, Business One-Party, Business Trunk and Centrex Services customers. The service will be provided on other types of end user lines where technically feasible.

(N)

D. Rates

There will be a nonrecurring charge of \$5.00 per line for each line equipped with Carrier Toll Restriction Services. End user customers with multiple lines billed to the same account will have all lines billed to the same presubscribed carrier blocked. The toll provider requesting Carrier Toll Restriction Service will be billed for the service.

(N)

PUBLIC SERVICE COMMISSION  
OF KENTUCKY  
EFFECTIVE

OCT 04 1998

PURSUANT TO 807 KAR 5:011,  
SECTION 9 (1)  
BY: Stephen D. Bell  
SECRETARY OF THE COMMISSION

ACCESS SERVICE TARIFF  
PSCK No. 2

CINCINNATI BELL TELEPHONE COMPANY

2nd Revised Page 537  
Cancels 1st Revised Page 537

13. Additional Engineering, Additional Labor and Miscellaneous Services (Cont'd)

13.3 Miscellaneous Services (Cont'd)

13.3.4 Standard Jacks - Registration Program

Standard jacks are provided by the Telephone company to connect Registered Equipment to those services that are subject to the Registration Program as set forth in Technical Reference Publication AS No. 1. The use of jacks is covered in Part 68 of the F.C.C.'s Rules and Regulations. Specific jacks are described in the document on file with the FCC entitled "Descriptions of Standard Registration Program Connection Configurations Supplementing Configurations Described in Subpart F of Part 68 of the FCC's Rules and Regulations."

These jacks are used to terminate services provided by the Telephone Company. Other services or facilities provided by the Telephone Company or by others may also be terminated in any spare capacity of the jacks remaining after installation without additional charge for the use of such capacity.

The nonrecurring charges, which include installation, for standard jacks and their typical uses are set forth following:

|   | <u>USOC</u> | <u>Nonrecurring<br/>Charges</u> | COMMISSION<br>OF KENTUCKY<br>EFFECTIVE  |
|---|-------------|---------------------------------|---|
| (A) <u>Standard Voice Jacks</u>   |             |                                 |   |
| (1) Miniature six-position jacks for connection of terminal equipment as follows: |             |                                 | MAY 23 1995   |
| (a) Single line telephone set, surface or flush mounted.                          | RJ11C       | \$25.79(I)                      | PURSUANT TO 807 KAR 5:011,<br>SECTION 19.01<br>BY: <u>Jordan C. Neal</u><br>FOR THE PUBLIC SERVICE COMMISSION |
| (b) Single line telephone sets, wall mounted.                                     | RJ11W       | 24.47(I)                        |   |

Issued: June 13, 1995

Effective: May 23, 1995

*Deborah D. Nisch*  
Vice President  
Integrated Corporate Planning for

President, Cincinnati, Ohio

ACCESS SERVICE TARIFF  
PSC No. 2

CINCINNATI BELL TELEPHONE COMPANY

2nd Revised Page 538  
Cancels 1st Revised Page 538

13. ~~Additional Engineering Additional Labor and Miscellaneous Services~~ (Cont'd)

13.3 ~~Miscellaneous Services~~ (Cont'd)

13.3.4 ~~Standard Jacks - Registration Program~~ (Cont'd)

(A) ~~Standard Voice Jacks~~ (Cont'd)

|   | <u>USOC</u> | <u>Nonrecurring<br/>Charges</u> |
|---|-------------|---------------------------------|
| (1) (Cont'd)  |             |                                 |
| (c) Two-line nonkey telephone sets, surface or flush mounted.   | RJ14C       | \$25.79(I)                      |
| (d) Single-line, bridged 4-wire exchange, 2/RT, T1/R1.  | RJ1DC       | 25.79 (I)                       |
| (e) Two-line nonkey telephone sets, wall mounted.   | RJ14W       | 25.96 (I)                       |
| (f) For Connection of two exchange access lines with a sliding cover for testing each line with a standard single line telephone                        | RJ14X       | 26.29(I)                        |
| (g) Special single line equipment for use in hospital critical care areas.  | RJ17C       | NONE(R)                         |
| (h) 9DB single line data equipment with mode indication and mode indication common leads. This jack is normally used in association with a series jack. | RJ16X       | 25.79(I)                        |

PUBLIC SERVICE COMMISSION  
OF KENTUCKY  
EFFECTIVE

MAY 23 1995

PURSUANT TO 807 KAR 5:011,  
SECTION 9 (1)

BY: Jordan C. Neal  
FOR THE PUBLIC SERVICE COMMISSION

Issued: June 13, 1995

Effective: May 23, 1995

*Deborah H. Hesch*  
Vice President  
Integrated Corporate Planning for

President, Cincinnati, Ohio

ACCESS SERVICE TARIFF  
PSCK No. 2

CINCINNATI BELL TELEPHONE COMPANY

2nd Revised Page 539  
Cancels 1st Revised Page 539

13. Additional Engineering, Additional Labor and Miscellaneous Services (Cont'd)

13.3 Miscellaneous Services (Cont'd)

13.3.4 Standard Jacks-Registration Program (Cont'd)

(A) Standard Voice Jacks (Cont'd)

|   | <u>USOC</u> | <u>Nonrecurring<br/>Charges</u> |
|---|-------------|---------------------------------|
| (1) (Cont'd)  |             |                                 |
| (i) Three-line non-key telephone sets and ancillary devices.  | RJ25C       | \$32.98 (I)                     |
| (j) Single-line non-key telephone and ancillary devices connected directly to central office lines where there is a requirement for make-busy.                | RJ18C       | \$32.98(I)                      |
| (k) Single-line, non-key telephone and ancillary devices connected directly to central office lines where there is a requirement for make-busy; wall mounted. | RJ18W       | \$24.47(I)                      |
| (2) 50 Position Miniature Ribbon for connection of multiline terminating equipment and channel derivation devices as follows:                                 |             |                                 |
| (a) For connection to 2-wire tie trunks; E&M type I signaling. (12 line capacity)   | RJ2EX       | \$98.20(I)                      |
| (b) For connection to 4-wire tie trunks; E&M type I signalings (8 line capacity)  | RJ2GX       | \$98.20(I)                      |

PUBLIC SERVICE COMMISSION  
OF KENTUCKY  
EFFECTIVE

MAY 23 1995

PURSUANT TO 807 KAR 5:011,  
SECTION 9(1)

BY: Jordan C. Neal  
FOR THE PUBLIC SERVICE COMMISSION

Issued: June 13, 1995

Effective: May 23, 1995

*Deborah A. Nisch*

President, Cincinnati, Ohio

Vice President

Integrated Corporate Planning for

ACCESS SERVICE TARIFF  
PSC No. 2

CINCINNATI BELL TELEPHONE COMPANY

2nd Revised Page 540  
Cancels 1st Revised Page 540

13. Additional Engineering, Additional Labor and Miscellaneous Services (Cont'd)

13.3 Miscellaneous Services (Cont'd)

13.3.4 Standard Jacks-Renistration Pronram (Cont'd)

(A) Standard Voice Jacks (Cont'd)

|   | USOC  | Nonrecurring<br>Charges |
|---|-------|-------------------------|
| (2) (Cont'd)  |       |                         |
| (c) For connection to 2-wire tie trunks; E&M type II signaling. (8 line capacity) | RJ2FX | \$ 98.20(I)             |
| (d) For connection to 4-wire tie trunks; E&M type II signaling. (6 line capacity) | RJ2HX | \$ 98.20(I)             |
| (e) For connection to off-premises station lines. (25 line capacity)              | RJ21X | \$ 98.20(I)             |
| (f) For use with series devices such as toll restrictors. (12 line capacity)      | RJ71C | \$102.26(I)             |
| (g) For connection of up to 12 lines, bridged 4-wire exchange, 2/RT, T1/R1.       | RJ2DX | \$ 98.20(I)             |

PUBLIC SERVICE COMMISSION  
OF KENTUCKY  
EFFECTIVE

MAY 23 1995

PURSUANT TO 807 KAR 5:011,  
SECTION 9(1)

BY: Jordan C. Neel  
FOR THE PUBLIC SERVICE COMMISSION

Issued: June 18, 1995

Effective: May 23, 1995

Deborah A. Neish  
Vice President  
Integrated Corporate Planning for

President, Cincinnati, Ohio

ACCESS SERVICE TARIFF  
PSCK No. 2

CINCINNATI BELL TELEPHONE COMPANY

2nd Revised Page 541  
Cancels 1st Revised Page 541

13. Additional Ennineerinn, Additional Labor and Miscellaneous Services (Cont'd)

13.3 Miscellaneous Services (Cont'd)

13.3.4 Standard Jacks-Registration Program (Cont'd)

(A) Standard Voice Jacks (Cont'd)

(2) (Cont'd)

(h) For connection of 2-12 nonkey telephone and ancillary devices connected directly to central office lines where there is a requirement for make-busy.

USOC

Nonrecurring  
Charnes

RJ2MB

\$102.26(I)

(3) Miniature Eight-Position Jack, four line, non-key telephone sets, for connection to ancillary devices and key telephone systems.

RJ61X

\$ 32.62(I)

(4) Series Jack for connection of terminal equipment as follows:

(a) Single line alarm reporting devices.

RJ31X

\$ 37.71(I)

(5) Miniature Eight-Position Series Jack for connection of alarm reporting devices

RJ38X

\$ 37.71(I)

(6) Weatherproof Jack for use with single line telephone sets used at locations such as boats and marinas.

RJ15C

\$149.90(I)

PUBLIC SERVICE COMMISSION  
OF KENTUCKY  
EFFECTIVE

MAY 23 1995

PURSUANT TO 807 KAR 5:011,  
SECTION 9(1)

BY: Jordan C. Neel  
FOR THE PUBLIC SERVICE COMMISSION

Issued: June 13, 1995

Effective: May 23, 1995

*Deborah A. Neish*  
Vice President  
Integrated Corporate Planning for

President, Cincinnati, Ohio

ACCESS SERVICE TARIFF  
PSCK No. 2

CINCINNATI BELL TELEPHONE COMPANY

2nd Revised Page 542  
Cancels 1st Revised Page 542

13. Additional Engineering, Additional Labor and Miscellaneous Services (Cont'd)

13.3 Miscellaneous Services (Cont'd)

13.3.4 Standard Jacks - Registration Program (Cont'd)

(B) Standard Data Jacks

|  | <u>USOC</u> | <u>Nonrecurring<br/>Charges</u> |
|--|-------------|---------------------------------|
| (1) Up to Eight-Miniature, Eight-Position Keyed Jacks, in multiple mounting arrangements. Multiple line bridged tip and ring. Multiple installations of a fixed loss loop (FLL) or programmed (P) types of data equipment. | RJ41M       | \$241.55(I)                     |
| (2) Universal Data Jack for use in connecting fixed loss loop (FU) and programmed (P) types of data equipment. (1 line capacity)   | RJ41S       | \$ 71.91(I)                     |
| (3) Up to Eight-Miniature, Eight Position Keyed Jacks, in multiple mounting arrangements. Multiple line bridged tip and ring. Multiple installations of programmed (P) types of data equipment.                            | RJ45M       | \$241.55(I)                     |
| (4) Programmed Data Jack for use in connecting programmed data equipment. (1 line capacity)  | RJ45S       | \$ 74.87(I)                     |

PUBLIC SERVICE COMMISSION  
OF KENTUCKY  
EFFECTIVE

MAY 23 1995

PURSUANT TO 807 KAR 5011,  
SECTION 9(1)

BY: Jordan C. Neal  
FOR THE PUBLIC SERVICE COMMISSION

Issued: June 13, 1995

Effective: ~~May~~ 23, 1995

Deborah A. Nisch President, Cincinnati, Ohio  
Vice President  
Integrated Corporate Planning for



ACCESS SERVICE TARIFF  
PSC No. 2

CINCINNATI BELL TELEPHONE COMPANY

2nd Revised Page 543  
Cancels 1st Revised Page 543

13. Additional Engineering, Additional Labor and Miscellaneous Services (Cont'd)

13.3 Miscellaneous Services (Cont'd)

13.3.4 Standard Jacks-Registration Program (Cont'd)

(B) Standard Data Jacks (Cont'd)

|   | <u>USOC</u> | <u>Nonrecurring<br/>Charges</u> |
|---|-------------|---------------------------------|
| (5) Multiple Line Uni-<br>versal Data Jack for<br>use in connecting<br>fixed loss loop (FLL)<br>and programmed (P)<br>types of data equip-<br>ment. This jack will<br>terminate up to eight<br>lines. The selection<br>of this jack requires<br>the use of the equip-<br>ment listed following. | RJ26X       | \$429.64(I)                     |
| (a) Multiple Line Uni-<br>versal Data Jack<br>Circuit Cards.<br>For use with RJ26X.<br>One circuit card<br>per circuit<br>required.   | RJ26S       | \$ 37.16(I)                     |
| (b) Multiple Line Universal<br>Data Jack Mounting<br>options. For use with<br>RJ26X. One required per<br>RJ26X.   |             |                                 |
| - Wall Mounting<br>with cover.  | m 3 x       | \$ 52.09(I)                     |
| - Rack Mounting<br>(19 inch or<br>23 inch)  | RJM4X       | \$ 58.02(I)                     |

PUBLIC SERVICE COMMISSION  
OF KENTUCKY  
EFFECTIVE

MAY 23 1995

PURSUANT TO 807 KAR 5:011,  
SECTION 9 (1)

BY: Jordan C. Neel  
FOR THE PUBLIC SERVICE COMMISSION

*Reborah Kirsch*  
Issued: June 13, 1995

Effective: May 23, 1995

Vice President  
Integrated Corporate Planning for

President, Cincinnati, Ohio

ACCESS SERVICE TARIFF  
PSCK No. 2

CINCINNATI BELL TELEPHONE COMPANY

2nd Revised Page 544  
Cancels 1st Revised Page 544

13. Additional Engineering, Additional Labor and Miscellaneous Services (Cont'd)

13.3 Miscellaneous Services (Cont'd)

13.3.4 Standard Jacks-Registration Program (Cont'd)

(B) Standard Data Jacks (Cont'd)

|  | USOC  | <u>Nonrecurring<br/>Charges</u> |
|--|-------|---------------------------------|
| (6) 50-Position Miniature Ribbon Jack, for programmed types of data equipment. Single or multiple-line bridged tip and ring. | RJ27X | \$98.20(I)                      |
| (7) Miniature Eight-Position Keyed Jack for connection of local area data channels and/or Digital Data Access Services.      | RJ48S | \$34.40(I)                      |
| (8) Miniature Fifty-Position Ribbon Jack for connection of local area data channels and/or Digital Data Access Services.*    | RJ48T | \$98.20(I)                      |
| (9) Miniature Eight Position Keyed Modular Jack equipped with make busy leads, tip and ring                                  | RJ4MB | \$61.25(I)                      |
| (10) Miniature Eight-Position Keyed Jack for Connection of Local Area Data Channels (Providing T-R and T1-R1).               | JN8   | \$34.40 (I)                     |

PUBLIC SERVICE COMMISSION  
OF KENTUCKY  
EFFECTIVE

MAY 23 1995

PURSUANT TO 807 KAR 5011,  
SECTION 9(1)

BY: Jordan C. Neal  
FOR THE PUBLIC SERVICE COMMISSION

\* The Telephone Company will wire the lines to the jack in the sequence designated by the customer.

Issued: June 13, 1995

Effective: May 23, 1995

*Deborah A. Risen*  
Vice President  
Integrated Corporate Planning for  
President, Cincinnati, Ohio

ACCESS SERVICE TARIFF  
PSCK No. 2

CINCINNATI BELL TELEPHONE COMPANY

1st Revised Page 544.1  
Cancels Original Page 544.1

13. Additional Ennineerinn. Additional Labor and Miscellaneous Services (Cont'd)

13.3 Miscellaneous Services (Cont'd)

13.3.4 Standard Jacks-Registration Program (Cont'd)

(C) Standard Digital Jacks

- |   |       |          |
|---|-------|----------|
| (1) Miniature Eight-Position Jack for connection of 1.544 Mbps Digital Services.  | RJ48C | 34.40(I) |
| (2) Miniature Eight-Position Jack for connection of 1.544 Mbps Digital Services. Tip and Ring T1-R1. Conductors 7 and 8 provide cable shield integrity. Conductors 3 and 6 are reserved for future use.               | RJ48X | 37.71(I) |
| (3) 50-Position Miniature Ribbon Jack for connection of 1.544 Mbps Digital Services. Eight tip and ring, eight T1-R1. Conductors 25 and 50 provide cable shield integrity. 16 conductors are reserved for future use. | RJ48M | 98.20(I) |
| (4) 50-Position Miniature Ribbon Jack connecting up to twelve 1.544 Mbps Digital lines. 12 four wire circuits, tip and ring and tip 1/ring 1.   | RJ48H | 98.20(I) |

PUBLIC SERVICE COMMISSION  
OF KENTUCKY  
EFFECTIVE

MAY 23 1995

PURSUANT TO 807 KAR 5:011,  
SECTION 9(1)

BY: Jordan C. Neal  
FOR THE PUBLIC SERVICE COMMISSION

Issued: June 13, 1995

Effective: May 23, 1995

*Deborah A. Nisch*  
Vice President  
Integrated Corporate Planning for  
President, Cincinnati, Ohio

13. Additional Engineering, Additional Labor and Miscellaneous Services (Cont'd)

13.3 Miscellaneous Services (Cont'd)

13.3.5 Testing Services

Testing Services offered under this section of the tariff are optional and subject to rates and charges as set forth in 13.3.5(C) following. Other testing services provided by the Telephone Company in association with Access Services are furnished at no additional charge. These other testing services are described in 6.1.6 and 7.1.7 preceding.

Testing services are normally provided by Telephone Company personnel at Telephone Company locations. However, provisions are made in (A)(5) and (B)(1) and (2) following for a customer to request Telephone Company personnel to perform testing services at the customer's premises.

The offering of Testing Services under this section of the tariff is made subject to the availability of the necessary qualified personnel and test equipment at the various test locations mentioned in (A), (B) and (C) following:

(A) Switched Access Service

Testing Services for Switched Access are comprised of (a) tests which are performed during the installation of a Switched Access Service, and (b) tests which are performed after acceptance of such access services by a customer, i.e., in-service tests. These in-service tests may be further divided into two broad categories of tests: scheduled and nonscheduled.

Scheduled tests are those tests performed by the Telephone Company on a regular basis, e.g., monthly which result in the measurement of Switched Access Service. Scheduled tests may be done on an automatic basis (no Telephone

PUBLIC SERVICE COMMISSION  
OF KENTUCKY  
EFFECTIVE

MAR 3 1992

PURSUANT TO 807 KAR 5:011,  
SECTION 9 (1)

BY: 

PUBLIC SERVICE COMMISSION

Effective: March 3, 1992

Issued: February 7, 1992

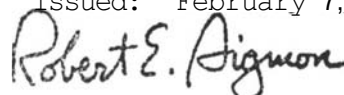
 for President, Cincinnati, Ohio

Vice President - Regulatory Affairs

ACCESS SERVICE TARIFF  
PSCK No. 2

CINCINNATI BELL TELEPHONE COMPANY

Original Page 546

13. Additional Engineering, Additional Labor and Miscellaneous Services (Cont'd)

13.3 Miscellaneous Services (Cont'd)

13.3.5 Testine Services (Cont'd)

(A) Switched Access Service (Cont'd)

Company or customer technicians involved), on a cooperative basis (Telephone Company technician(s) involved at Telephone Company office(s) and customer technician(s) involved at customer's premises), or a manual basis (Telephone Company technician(s) involved at Telephone Company office(s) and at customer's premises).

Nonscheduled tests are performed by the Telephone Company "on demand", which result in the measurement of Switched Access Services. Nonscheduled tests may involve Telephone Company technicians at Telephone Company offices and at the customer's premises.

(1) Additional Cooperative Acceptance Testing

Additional Cooperative Acceptance Testing (ACAT) or Switched Access Service involves the Telephone Company provision of a technician at its office(s) and the customer provides a technician at its premises, with suitable test equipment to perform the required tests.

Additional Cooperative Acceptance Tests may, for example, consists of the following tests:

- . Impulse Noise
- . Phase Jitter
- . Signal to C-Notched Noise Ratio
- . Intermodulation (Nonlinear) Distortion
- . Frequency Shift (Offset)
- . Envelope Delay Distortion
- . Dial Pulse Percent Break

(2) Automatic Scheduled Testing

Automatic Schedules Testing (AST) of Switched Access Services (Feature Groups B and D), where the

PUBLIC SERVICE COMMISSION  
OF KENTUCKY  
EFFECTIVE

MAR 3 1992

PURSUANT TO 807 KAR 5:011,

Issued: February 7, 1992

Effective: March 19, 1992

*Robert E. Aignone* for President, Cincinnati, Ohio

BY: *Chouhelle*  
PUBLIC SERVICE COMMISSION MANAGER

Vice President - Regulatory Affairs

ACCESS SERVICE TARIFF  
PSCK No. 2

CINCINNATI BELL TELEPHONE COMPANY

Original Page 547

13. Additional Engineering. Additional Labor and Miscellaneous Services (Cont'd)

13.3 Miscellaneous Services (Cont'd)

13.3.5 Testing Services (Cont'd)

(A) Switched Access Service (Cont'd)

(2) Automatic Scheduled Testing (Cont'd)

provides remote office test lines and 105 test lines with associated responders or their functional equivalent, will consist of monthly loss and C-message noise tests and annual balance test. However, the customer may specify a more frequent schedule of tests. In addition to the loss/noise/balance tests, the IC may also order, at additional charges, gain-slope and C-notched noise testing.

The Telephone Company will provide a monthly AST report that lists the test results for each trunk tested. Trunk test failures requiring customer participation for trouble resolution will be provided to the customer on an as-occurs basis.

PUBLIC SERVICE COMMISSION  
OF KENTUCKY  
EFFECTIVE

MAR 3 1992

PURSUANT TO 807 KAR 5:011,  
SECTION 9 (1)

BY:   
PUBLIC SERVICE COMMISSION MANAGER

Issued: February 7, 1992

Effective: March 3, 1992

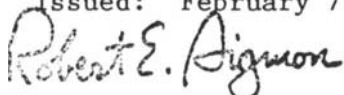

for

President, Cincinnati, Ohio

**Vice President - Regulatory Affairs**

ACCESS SERVICE TARIFF  
PSCK No. 2

CINCINNATI BELL TELEPHONE COMPANY

Original Page 548

13. Additional Engineering, Additional Labor and Miscellaneous Services (Cont'd)

13.3 Miscellaneous Services (Cont'd)

13.3.5 Testing Services (Cont'd)

(A) Switched Access Service (Cont'd)

(3) Cooperative Scheduled Testing

Cooperative Scheduled Testing (CST) of Switched Access Services (Features Groups B and D and Directory Access Service not routed through an access tandem), where the Telephone Company provides a technician at its office(s) and the customer provides a technician at its premises, with suitable test equipment to perform the required tests, will consist of quarterly loss and C-message noise tests, and annual balance tests. However, the customer may specify a more frequent schedule of tests. In addition to the loss/noise/balance measurements, the customer may also order, at additional charges, gain-slope and C-notched noise testing.

The Telephone Company will provide, on a quarterly basis, a CST report that lists the test results for each trunk tested. Trunk test failures requiring customer participation for trouble resolution will be provided to the customer on an as-occurs basis.

PUBLIC SERVICE COMMISSION  
OF KENTUCKY  
EFFECTIVE

MAR 3 1992

PURSUANT TO 807 KAR 5:011,  
SECTION 3 (1)

BY.   
PUBLIC SERVICE COMMISSION MANAGER

Effective: March 3, 1992

Issued: February 7, 1992

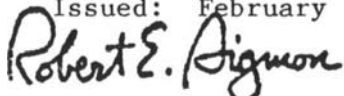
 for

President, Cincinnati, Ohio

Vice President - Regulatory Affairs

ACCESS SERVICE TARIFF  
PSCK No. 2

CINCINNATI BELL TELEPHONE COMPANY

Original Page 549

13. Additional Engineering, Additional Labor and Miscellaneous Services (Cont'd)

13.3 Miscellaneous Services (Cont'd)

13.3.5 Testing: Services (Cont'd)

(A) Switched Access Service (Cont'd)

(4) Manual Scheduled Testing

Manual Scheduled Testing (MST) of Switched Access Services (Feature Groups B, D and Directory Access Service not routed through an access tandem), where the Telephone Company provides a technician at its office(s) and at the customer's premises, will consist of quarterly loss and C-message noise tests, and annual balance tests. However, the customer may specify a more frequent schedule of tests. In addition to the loss/noise/balance tests, the customer may also order, at additional charges, gain-slope and C-notched noise testing.

The Telephone Company will provide, on a quarterly basis, an MST report that lists the test results for each trunk tested. Trunk test failures requiring customer participation for trouble resolution will be provided to the customer on an as-occurs basis.

PUBLIC SERVICE COMMISSION  
OF KENTUCKY  
EFFECTIVE

MAR 3 1992

PURSUANT TO 807 KAR 5:011,  
SECTION 9 (1)

BY: 

Issued: February 7, 1992

Effective:  March 3, 1992 AC .

 for President, Cincinnati, Ohio

Vice President - Regulatory Affairs



ACCESS SERVICE TARIFF  
PSC No. 2

CINCINNATI BELL TELEPHONE COMPANY

Original Page 550

13. Additional Engineering, Additional Labor and Miscellaneous Services (Cont'd)

13.3 Miscellaneous Services (Cont'd)

13.3.5 Testing Services (Cont'd)

(A) Switched Access Service (Cont'd)

(5) Nonscheduled Testing

Nonscheduled Testing (NST) of Switched Access Services is where:

- the customer provides remote office test lines and 105 test lines with associated responders or their functional equivalent ("automatic testing"), or
- the Telephone Company provides a technician at its office(s) and the customer provides a technician at its premises, with suitable test equipment to perform the required test ("cooperative testing"), or
- the Telephone Company provides a technician at its office(s), and/or at the customer's premises with suitable test equipment to perform the required tests ("manual testing")

Nonscheduled Tests may consist of any tests, e.g., loss, noise, slope, envelope delay, which the customer may require.

(6) Obligations of the Customer

(A) The customer shall provide the Remote Office Test Line priming data to the Telephone Company, as appropriate, to support AST as set forth in 13.3.5(a)(2) preceding or NST as set forth in 13.3.5(A) (5) preceding.

(B) The customer shall make the facilities to be tested available to the Telephone Company at times mutually agreed upon.

PUBLIC SERVICE COMMISSION  
OF KENTUCKY  
EFFECTIVE

MAR 3 1992

PURSUANT TO 807 KAR 5:011.

Effective: SECTION 9(1)  
March 3, 1992

BY: *[Signature]*  
PUBLIC SERVICE COMMISSION MANAGER

7, 1992  
*Robert E. Aigmon* for President, Cincinnati, Ohio

Vice President - Regulatory Affairs

13. Additional Engineering, Additional Labor and Miscellaneous Services (Cont'd)

13.3 Miscellaneous Services (Cont'd)

13.3.5 Testing Services (Cont'd)

(B) Special Access Service

The Telephone Company will, at the request of a customer, provide assistance in performing specific tests requested by the customer.

(1) Additional Cooperative Acceptance Testing (ACAT)

When a customer provides a technician at its premises or at an end user's premises, with suitable test equipment to perform the requested tests, the Telephone Company will provide a technician at its office for the purpose of conducting Additional Cooperative Acceptance Testing on Voice Grade Services. At the customer's request, the Telephone Company will provide a technician at the customer's premises or at the end user premises. These tests may, e.g., consist of the following:

- Attenuation Distortion (i.e., frequency response)
- Intermodulation Distortion (i.e., harmonic distortion)
- Phase Jitter
- Impulse Noise
- Envelope Delay Distortion
- Echo Control
- Frequency Shift

(2) Nonscheduled Testing (NST)

When a customer provides a technician at its premises, with suitable test equipment to perform the required tests, the Telephone Company will provide a technician at its office for the purpose of conducting Nonscheduled Testing. At the customer's request, the Telephone Company will provide a technician at the customer's premises. Nonscheduled tests may consist of any tests, e.g., loss, noise, slope, envelope delay, which the customer may require.

MAR 3 1992

PURSUANT TO 807 KAR 5:011.

Effective: SECTION 9(1)  
March 3, 1992  
BY: *Cheryl Miller*  
PUBLIC SERVICE COMMISSION MANAGER

Issued: February 7, 1992  
*Robert E. Bignone*

for

President, Cincinnati, Ohio

Vice President - Regulatory Affairs

ACCESS SERVICE TARIFF  
PSCK No. 2

CINCINNATI BELL TELEPHONE COMPANY

2nd Revised Page 552  
Cancels 1st Revised Page 552

13. Additional Ennineerinn, Additional Labor and Miscellaneous Services (Cont'd)

13.3 Miscellaneous Services (Cont'd)

13.3.5 Testinn Services (Cont'd)

(B) Special Access Service (Cont'd)

(3) Obligations of the Customer

When the customer subscribes to Testing Services as set forth in this section, the customer shall make the facilities to be tested available to the Telephone Company at times mutually agreed upon.

PUBLIC SERVICE COMMISSION  
OF KENTUCKY  
EFFECTIVE

(C) Rates and Charges

(1) Switched Access

(a) Additional Cooperative Acceptance Testing

MAY 23 1995

PURSUANT TO 807 KAR 5.011,  
SECTION 9 (1)

BY: Jordan C. Neel  
FOR THE PUBLIC SERVICE COMMISSION

| <u>Testing Periods</u>   | <u>USOC</u> | <u>First Half Hour or Fraction Thereof</u> | <u>Each Additional Half Hour or Fraction Thereof</u> |
|--|-------------|--|--|
| Basic Time, normally scheduled working hours#                                  | UBCX+       | \$41.58 (I)                                | \$30.02 (I)  |
| Overtime, outside of normally scheduled working hours on a scheduled work day# | UBCX+       | 56.60*                                     | 45.04*   |
| Premium Time, outside of scheduled vork day#                                   | UBCX+       | 71.61* (I)                                 | 60.05* (I)   |

# If more than one technician is involved with the same testing project, the total amount of time for all technicians involved will be aggregated prior to the distribution of time between the "First Half Hour or Fraction Thereof" and "Each Additional Half Hour or Fraction Thereof" rate categories.

\* A call-out of a Telephone Company employee at a time not consecutive with the employee's scheduled work period is subject to a minimum charge of four hours.

Issued: **June 13, 1995**

Effective: **May 23, 1995**

*Leborah A. Nisch*

President, Cincinnati, Ohio

ice President  
egrated Corporate Planning for

ACCESS SERVICE TARIFF  
PSC No. 2

CINCINNATI BELL TELEPHONE COMPANY

1st Revised Page 553  
Cancels Original Page 553

13. Additional Engineering, Additional Labor and Miscellaneous Services (Cont'd)

13.3 Miscellaneous Services (Cont'd)

13.3.5 Testing Services (Cont'd)

(C) Rates and Charges (Cont'd)

(1) Switched Access (Cont'd)

(b) Automatic Scheduled Testing (AST)

The three tests as set forth in (I) following represent the minimum offering, i.e., an order for testing must, at a minimum, consist of twelve 1004 Hz Tests per transmission path, twelve C-Message Noise Tests per transmission path and one Return Loss (Balance) Test per transmission path, per year. The Additional Tests as set forth in (II) following may be ordered by the customer, at additional charges, 60 days prior to the start of the customer prescribed schedule. The customer also may specify a more frequent schedule of tests 60 days prior to the start of the customer prescribed schedule.

| <u>To First Point</u><br><u>of Switching</u>   | <u>USOC</u> | <u>Monthly</u><br><u>Rates</u> |
|--|-------------|--------------------------------|
| (I) Basic Tests #  |             |                                |
| 1004 Hz Loss Tests performed within a one year period, per test ordered, per transmission path | UBGX+       | \$0.08 (R)                     |

# Subject to a one year minimum contract period, and annually

PUBLIC SERVICE COMMISSION  
OF KENTUCKY  
EFFECTIVE

OCT 26 1992

PURSUANT TO 807 KAR 5.011.

Issued: September 24, 1992

Effective: ~~Section 3(1)~~ 1992

*Robert E. Aigmon* for President, Cincinnati, Ohio

BY: *Chapman Haller*  
PUBLIC SERVICE COMMISSION MANAGER

Vice President - Regulatory Affairs

ACCESS SERVICE TARIFF  
PSCK No. 2

CINCINNATI BELL TELEPHONE COMPANY

1st Revised Page 554  
Cancels Original Page 554

13. Additional Engineering, Additional Labor and Miscellaneous Services (Cont'd)

13.3 Miscellaneous Services (Cont'd)

13.3.5 Testing Services (Cont'd)

(C) Rates and Charges (Cont'd)

(1) Switched Access (Cont'd)

(b) Automatic Scheduled Testing (AST) (Cont'd)

| <u>To First Point<br/>of Switching</u>   | <u>USOC</u> | <u>Monthly<br/>Rates</u> |     |
|--|-------------|--------------------------|-----|
| (I) Basic Tests # (Cont'd)   |             |                          |     |
| C-Message Noise Tests<br>performed within a<br>one year period,<br>per test ordered,<br>per transmission path          | UBGX+       | \$0.08                   | (R) |
| Return Loss<br>(Balance) Tests<br>performed within a<br>one year period,<br>per test ordered,<br>per transmission path | UBGX+       | 0.08                     |     |
| (II) Additional Tests  |             |                          |     |
| Gain-Slope Tests<br>performed within a<br>one year period,<br>per test ordered,<br>per transmission path               | UBGX+       | 0.08                     | (R) |

PUBLIC SERVICE COMMISSION  
OF KENTUCKY  
EFFECTIVE

OCT 26 1992

# Subject to a one year minimum contract period, and annually thereafter.

PURSUANT TO 807 KAR 5:011,  
SECTION 9 (1)

BY: Cheryl Hallett  
PUBLIC SERVICE COMMISSION MANAGER

Issued: September 24, 1992

Effective: October 26, 1992

Robert E. Aigmon for President, Cincinnati, Ohio

Vice President - Regulatory Affairs

ACCESS SERVICE TARIFF  
PSC No. 2

CINCINNATI BELL TELEPHONE COMPANY

1st Revised Page 555  
Cancels Original Page 555

13. Additional Engineering, Additional Labor and Miscellaneous Services (Cont'd)

13.3 Miscellaneous Services (Cont'd)

13.3.5 Testing Services (Cont'd)

(C) Rates and Charges (Cont'd)

(1) Switched Access (Cont'd)

(b) Automatic Scheduled Testing (AST) (Cont'd)

| <u>To First Point<br/>of Switching</u> | <u>USOC</u> | <u>Monthly<br/>Rates</u> |
|--|-------------|--------------------------|
|--|-------------|--------------------------|

(11) Additional Tests (Cont'd)

C-Notched Noise Tests  
performed within a  
one year period,

|                       |       |        |     |
|-----------------------|-------|--------|-----|
| per test ordered,     | UBGX+ | \$0.08 | (R) |
| per transmission path |       |        |     |

(III) Example

A customer schedules 13 1004 Hz Loss Tests,  
13 C-Message Noise Tests and 2 Return Loss  
Tests on one trunk for a year. The charges  
will be computed as follows:

|                   |  |
|-------------------|--|
| 13 x .08 = \$1.04 |  |
| +13 x .08 = 1.04  |  |
| + 2 x .08 = .16   |  |

(TI  
|  
(T)

\$2.24 per month, per trunk

PUBLIC SERVICE COMMISSION  
OF KENTUCKY  
EFFECTIVE

OCT 26 1992

PURSUANT TO 807 KAR 5:011,  
SECTION 9 (1)

BY: *Clayton Diller*  
PUBLIC SERVICE COMMISSION MANAGER

Issued: September 24, 1992

Effective: September 26, 1992

*Robert E. Aigmon* for President, Cincinnati, Ohio

Vice President - Regulatory Affairs

ACCESS SERVICE TARIFF  
PSC No. 2

CINCINNATI BELL TELEPHONE COMPANY

2nd Revised Page 556  
Cancels 1st Revised Page 556

13. Additional Engineering, Additional Labor and Miscellaneous Services (Cont'd)

13.3 Miscellaneous Services (Cont'd)

13.3.5 Testing Services (Cont'd)

(C) Rates and Charges (Cont'd)

(1) Switched Access (Cont'd)

(c) Cooperative Scheduled Testing (CST)

The three tests as set forth in (I) following represent the minimum offering, i.e., an order for testing must, at a minimum, consist of four 1004 Hz Loss Tests per transmission path, four C-Message Noise Tests per transmission path and one Return Loss (Balance) Test per transmission path, per year. The Additional Tests as set forth in (11) following may be ordered by the customer, at additional charges, 60 days prior to the start of the customer prescribed schedule. The customer also may specify a more frequent schedule of tests 60 days prior to the start of the customer prescribed schedule.

| <u>To First Point<br/>of Switching</u> | <u>USOC</u> | <u>Monthly<br/>Rates</u> |
|--|-------------|--------------------------|
|--|-------------|--------------------------|

(I) Basic Tests #

|  |       |           |
|--|-------|-----------|
| 1004 Hz Loss Tests performed within a one year period, per test ordered, per transmission path | UBSX+ | \$ .95(I) |
|--|-------|-----------|

PUBLIC SERVICE COMMISSION  
OF KENTUCKY  
EFFECTIVE

MAY 23 1995

PURSUANT TO 807 KAR 5:011,  
SECTION 9 (1)

BY: Jordan C. Neal  
FOR THE PUBLIC SERVICE COMMISSION

# Subject to a one year minimum contract period, and annually thereafter.

Issued: June 13, 1995  
Deborah K. Risch  
Vice President  
Integrated Corporate Planning for

Effective: May 23, 1995

President, Cincinnati, Ohio

ACCESS SERVICE TARIFF  
PSC No. 2

CINCINNATI BELL TELEPHONE COMPANY

2nd Revised Page 557  
Cancels 1st Revised Page 557

13. Additional Engineering, Additional Labor and Miscellaneous Services  
(Cont'd)

13.3 Miscellaneous Services (Cont'd)

13.3.5 Testing Services (Cont'd)

(C) Rates and Charges (Cont'd)

(1) Switched Access (Cont'd)

(c) Cooperative Scheduled Testing (CST)  
(Cont'd)

| <u>To First Point<br/>of Switchinn</u>   | <u>USOC</u> | <u>Monthly<br/>Rates</u> |     |
|--|-------------|--------------------------|-----|
| (I) Basic Tests # (Cont'd)   |             |                          |     |
| C-Message Noise Tests<br>performed within a<br>one year period,<br>per test ordered,<br>per transmission path          | UBSX+       | \$0.87                   | (I) |
| Return Loss<br>(Balance) Tests<br>performed within a<br>one year period,<br>per test ordered,<br>per transmission path | UBSX+       | 1.63                     |     |
| (11) Additional Tests  |             |                          |     |
| Gain-Slope Tests<br>performed within a<br>one year period,<br>per test ordered,<br>per transmission path               | UBSX+       | 1.29                     | (I) |

PUBLIC SERVICE COMMISSION  
OF KENTUCKY  
EFFECTIVE

MAY 23 1995

PURSUANT TO 807 KAR 5:011,  
SECTION 9(1)

BY: Jordan C. Neel  
FOR THE PUBLIC SERVICE COMMISSION

# Subject to a one year minimum contract period, and annually thereafter.

Issued: June 13, 1995

Effective: May 23, 1995

*Deborah A. Neish*  
Vice President

President, Cincinnati, Ohio

Integrated Corporate Planning for



ACCESS SERVICE TARIFF  
PSCK No. 2

CINCINNATI BELL TELEPHONE COMPANY

2nd Revised Page 558  
Cancels 1st Revised Page 558

13. Additional Engineering, Additional Labor and Miscellaneous Services  
(Cont'd)

13.3 Miscellaneous Services (Cont'd)

13.3.5 Testinn Services (Cont'd)

(C) Rates and Charges (Cont'd)

(1) Switched Access (Cont'd)

(c) Cooperative Scheduled Testinn (CST) (Cont'd)

|                                       |             |                          |
|---------------------------------------|-------------|--------------------------|
| To First Point<br><u>of Switching</u> | <u>USOC</u> | <u>Monthly<br/>Rates</u> |
|---------------------------------------|-------------|--------------------------|

(II) Additional Tests (Cont'd)

|   |        |     |
|---|--------|-----|
| C-Notched Noise Tests<br>performed within a<br>one year period,<br>per test ordered,<br>per transmission path UBSX+ | \$0.87 | (I) |
|---|--------|-----|

(III) Example

A customer schedules 6 1004 Hz Loss Tests, 6 C-Message Noise Tests and 4 Return Loss Tests on one trunk for a year. The charges will be computed as follows:

|                              |     |
|------------------------------|-----|
| 6 x .95 = \$ 5.70            | (T) |
| +6 x .87 = 5.22              |     |
| +4 x 1.63 = <u>6.52</u>      | (T) |
| \$17.44 per month, per trunk |     |

PUBLIC SERVICE COMMISSION  
OF KENTUCKY  
EFFECTIVE

MAY 23 1995

PURSUANT TO 807 KAR 5.011,  
SECTION 9(1)

BY: Jordan C. Neal  
FOR THE PUBLIC SERVICE COMMISSION

Issued: ~~June~~ 13, 1995

Effective: **May** 23, 1995

*Deborah A. Nisch* President, Cincinnati, Ohio  
Vice President  
Integrated Corporate Planning for

ACCESS SERVICE TARIFF  
PSCK No. 2

CINCINNATI BELL TELEPHONE COMPANY

2nd Revised Page 559  
Cancels 1st Revised Page 559

13. Additional Engineering, Additional Labor and Miscellaneous Services (Cont'd)

13.3 Miscellaneous Services (Cont'd)

13.3.5 Testing Services (Cont'd)

(C) Rates and Charges (Cont'd)

(1) Switched Access (Cont'd)

(d) Manual Scheduled Testing (MST)

The three tests as set forth in (I) following represent the minimum offering, i.e., an order for testing must, at a minimum, consist of four 1004 Hz Loss Tests per transmission path, four C-Message Noise Tests per transmission path and one Return Loss (Balance) Test per transmission path, per year. The Additional Tests as set forth in (II) following may be ordered by the customer, at additional charges, 60 days prior to the start of the customer prescribed schedule. The customer also may specify a more frequent schedule of tests 60 days prior to the start of the customer prescribed schedule.

| <u>To First Point<br/>of Switching</u>   | <u>USOC</u> | <u>Monthly<br/>Rates</u> |     |
|--|-------------|--------------------------|-----|
| (I) Basic Tests #  |             |                          |     |
| 1004 Hz Loss Tests<br>performed within a<br>one year period,<br>per test ordered,<br>per transmission path | UBMX+       | \$1.43                   | (I) |

PUBLIC SERVICE COMMISSION  
OF KENTUCKY  
EFFECTIVE

MAY 23 1995

PURSUANT TO 807 KAR 5:011,  
SECTION 9 (1)

BY: Jordan C. Neal  
FOR THE PUBLIC SERVICE COMMISSION

# Subject to a one year minimum contract period, and annually thereafter.

Issued: June 13, 1995

Effective: May 23, 1995

Deborah H. Nisch  
Vice President  
Integrated Corporate Planning for

President, Cincinnati, Ohio

ACCESS SERVICE TARIFF  
PSCK No. 2

CINCINNATI BELL TELEPHONE COMPANY

2nd Revised Page 560  
Cancels 1st Revised Page 560

13. Additional Engineering, Additional Labor and Miscellaneous Services (Cont'd)

13.3 Miscellaneous Services (Cont'd)

13.3.5 Testing Services (Cont'd)

(C) Rates and Charges (Cont'd)

(1) Switched Access (Cont'd)

(d) Manual Scheduled Testing (MST) (Cont'd)

| <u>To First Point<br/>of Switching</u> | <u>USOC</u> | <u>Monthly<br/>Rates</u> |
|--|-------------|--------------------------|
|--|-------------|--------------------------|

(I) Basic Tests # (Cont'd)

C-Message Noise Tests  
performed within a  
one year period,  
per test ordered,  
per transmission path

UBMX+ \$1.27

(I)

Return Loss  
(Balance) Tests  
performed within a  
one year period,  
per test ordered,  
per transmission  
path

UBMX+ 2.76

(II) Additional Tests

Gain-Slope Tests  
performed within a  
one year period,  
per test ordered,  
per transmission path

UBMX+ 2.09

(I)

PUBLIC SERVICE COMMISSION  
OF KENTUCKY  
EFFECTIVE

MAY 23 1995

PURSUANT TO 807 KAR 5:011,  
SECTION 9(1)

BY: Jordan C. Neel  
FOR THE PUBLIC SERVICE COMMISSION

# Subject to a one year minimum contract, and annually thereafter.

Deborah D. Smith  
Issued June 13, 1995  
Vice President  
Integrated Corporate Planning for

President, Cincinnati, Ohio

Effective: May 23, 1995

ACCESS SERVICE TARIFF  
PSCK No. 2

CINCINNATI BELL TELEPHONE COMPANY

2nd Revised Page 561  
Cancels 1st Revised Page 561

13. Additional Engineering, Additional Labor and Miscellaneous Services (Cont'd)

13.3 Miscellaneous Services (Cont'd)

13.3.5 Testing Services (Cont'd)

(C) Rates and Charges (Cont'd)

(1) Switched Access (Cont'd)

(d) Manual Scheduled Testing (MST) (Cont'd)

| <u>To First Point<br/>of Switching</u> | <u>USOC</u> | <u>Monthly<br/>Rates</u> |
|--|-------------|--------------------------|
|--|-------------|--------------------------|

(II) Additional Tests (Cont'd)

|   |  |        |     |
|---|--|--------|-----|
| C-Notched Noise Tests<br>performed within a<br>one year period,<br>per test ordered,<br>per transmission path UBMX+ |  | \$1.27 | (I) |
|---|--|--------|-----|

(III) Example

See (c)(III) preceding.

PUBLIC SERVICE COMMISSION  
OF KENTUCKY  
EFFECTIVE

MAY 23 1995

PURSUANT TO 807 KAR 5.011,  
SECTION 9(1)

BY: Jordan C. Neal  
FOR THE PUBLIC SERVICE COMMISSION

Issued: June 13, 1995

Effective: May 23, 1995

Reborah R. Risch  
Vice President  
Integrated Corporate Planning for

President, Cincinnati, Ohio

ACCESS SERVICE TARIFF  
PSCK No. 2

CINCINNATI BELL TELEPHONE COMPANY

2nd Revised Page 562  
Cancels 1st Revised Page 562

13. Additional Engineering, Additional Labor and Miscellaneous Services (Cont'd)

13.3 Miscellaneous Services (Cont'd)

13.3.5 Testing Services (Cont'd)

(C) Rates and Charges (Cont'd)

(1) Switched Access (Cont'd)

(e) Nonscheduled Testing (NST)

Automatic Testing:

| <u>To First Point<br/>of Switching</u>         | <u>USOC</u> | <u>Nonrecurring<br/>Charges</u> |     |
|--|-------------|---------------------------------|-----|
| 1004 Hz Loss,<br>per test performed            | USCX+       | \$27.52                         | (I) |
| C-Message Noise,<br>per test performed         | USCX+       | \$27.52                         |     |
| Return Loss<br>(Balance)<br>per test performed | USCX+       | 27.52                           |     |
| Gain-Slope<br>per test performed               | USCX+       | 27.52                           |     |
| C-Notched Noise,<br>per test performed         | USCX+       | 27.52                           | (I) |

PUBLIC SERVICE COMMISSION  
OF KENTUCKY  
EFFECTIVE

MAY 23 1995

PURSUANT TO 807 KAR 5:011,  
SECTION 9(1)

BY: Jordan C. Neel  
FOR THE PUBLIC SERVICE COMMISSION

Issued: June 13, 1995

Effective: May 23, 1995

Deborah A. Nisch President, Cincinnati, Ohio  
Vice President  
Integrated Corporate Planning for

ACCESS SERVICE TARIFF  
PSCK No. 2

CINCINNATI BELL TELEPHONE COMPANY

2nd Revised Page 563  
Cancels 1st Revised Page 563

13. Additional Engineering, Additional Labor and Miscellaneous Services (Cont'd)

13.3 Miscellaneous Services (Cont'd)

13.3.5 Testing Services (Cont'd)

(C) Rates and Charges (Cont'd)

(1) Switched Access (Cont'd)

(e) Nonscheduled Testing (NST) (Cont'd)

Cooperative Testing:

| <u>Testing Periods</u>   | <u>USOC</u> | <u>First Half Hour or Fraction Thereof</u> | <u>Each Additional Half Hour or Fraction Thereof</u> |
|--|-------------|--|--|
| Basic Time, normally scheduled working hours#                                  | USSX+       | \$41.58 (I)                                | \$30.02 (I)  |
| Overtime, outside of normally scheduled working hours on a scheduled work day# | USSX+       | 56.60*                                     | 45.04*   |
| Premium Time, outside of scheduled work day#                                   | USSX+       | 71.61* (I)                                 | 60.05* (I)   |

PUBLIC SERVICE COMMISSION  
OF KENTUCKY  
EFFECTIVE

MAY 23 1995

PURSUANT TO 807 KAR 5:011,  
SECTION 9 (1)

BY: Jordan C. Neal  
FOR THE PUBLIC SERVICE COMMISSION

# If more than one technician is involved with the same testing project, the total amount of time for all technicians involved will be aggregated prior to the distribution of time between the "First Half Hour or Fraction Thereof" and "Each Additional Half Hour or Fraction Thereof" rate categories.

\* A call-out of a Telephone Company employee at a time not consecutive with the employee's scheduled work period is subject to a minimum charge of four hours.

Issued: June 13, 1995  
Deborah H. Busch  
Vice President  
Integrated Corporate Planning for  
President, Cincinnati, Ohio

Effective: May 23, 1995

ACCESS SERVICE TARIFF  
PSCK No. 2

CINCINNATI BELL TELEPHONE COMPANY

2nd Revised Page 564  
Cancels 1st Revised Page 564

13. Additional Engineering, Additional Labor and Miscellaneous Services (Cont'd)

13.3 Miscellaneous Services (Cont'd)

13.3.5 Testing Services (Cont'd)

(C) Rates and Charges (Cont'd)

(1) Switched Access (Cont'd)

(e) Nonscheduled Testing (NST) (Cont'd)

Manual Testing:

| <u>Testing Periods</u>   | <u>USOC</u> | <u>First Half Hour or Fraction Thereof</u> | <u>Each Additional Half Hour or Fraction Thereof</u> |
|--|-------------|--|--|
| Basic Time,<br>normally scheduled<br>working hours#  | USMX+       | \$41.58 (I)                                | \$30.02 (I)  |
| Overtime,<br>outside of normally<br>scheduled working<br>hours on a scheduled<br>work day# | USMX+       | 56.60*                                     | 45.04*   |
| Premium Time,<br>outside of scheduled<br>work day#   | USMX+       | 71.61* (I)                                 | 60.05* (I)   |

PUBLIC SERVICE COMMISSION  
OF KENTUCKY  
EFFECTIVE

MAY 23 1995

PURSUANT TO 807 KAR 5:011,  
SECTION 9(1)

BY: Jordan C. Neel  
FOR THE PUBLIC SERVICE COMMISSION

# If more than one technician is involved with the same additional testing project, the total amount of time for all technicians involved will be aggregated prior to the distribution of time between the "First Half Hour or Fraction Thereof" and "Each Additional Half Hour or Fraction Thereof" rate categories.

\* A call-out of a Telephone Company employee at a time not consecutive with the employee's scheduled work period is subject to a minimum charge of four hours.

Issued: June 13, 1995  
Deborah H. Hesch  
Vice President  
Integrated Corporate Planning for

President, Cincinnati, Ohio

Effective: May 23, 1995

ACCESS SERVICE TARIFF  
PSCK No. 2

CINCINNATI BELL TELEPHONE COMPANY

2nd Revised Page 565  
Cancels 1st Revised Page 565

13. Additional Engineering, Additional Labor and Miscellaneous Services (Cont'd)

13.3 Miscellaneous Services (Cont'd)

13.3.5 Testing Services (Cont'd)

(C) Rates and Charges (Cont'd)

(2) Special Access

(a) Additional Cooperative Acceptance Testing (ACAT)

| <u>Testing Periods</u>   | <u>USOC</u> | <u>First Half Hour or Fraction Thereof</u> | <u>Each Additional Half Hour or Fraction Thereof</u> |
|--|-------------|--|--|
| Basic Time, normally scheduled working hours#                                  | SNTX+       | \$41.58 (I)                                | \$30.02 (I)  |
| Overtime, outside of normally scheduled working hours on a scheduled work day# | SNTX+       | 56.60*                                     | 45.04*   |
| Premium Time, outside of scheduled work day#                                   | SNTX+       | 71.61* (I)                                 | 60.05* (I)   |

PUBLIC SERVICE COMMISSION  
OF KENTUCKY  
EFFECTIVE

MAY 23 1995

PURSUANT TO 807 KAR 5.011,  
SECTION 9 (1)

BY: Jordan C. Neal  
FOR THE PUBLIC SERVICE COMMISSION

# If more than one technician is involved with the same testing project, the total amount of time for all technicians involved will be aggregated prior to the distribution of time between the "First Half Hour or Fraction Thereof" and "Each Additional Half Hour or Fraction Thereof" rate categories.

\* A call-out of a Telephone Company employee at a time not consecutive with the employee's scheduled work period is subject to a minimum charge of four hours.

Issued: June 13, 1995

Effective: May 23, 1995

Deborah D. Ditch  
Vice President  
Integrated Corporate Planning for  
President, Cincinnati, Ohio



ACCESS SERVICE TARIFF  
PSCK No. 2

CINCINNATI BELL TELEPHONE COMPANY

2nd Revised Page 566  
Cancels 1st Revised Page 566

13. Additional Engineering, Additional Labor and Miscellaneous Services (Cont'd)

13.3 Miscellaneous Services (Cont'd)

13.3.5 Testing Services (Cont'd)

(C) Rates and Charges (Cont'd)

(2) Special Access (Cont'd)

(b) Nonscheduled Testing (NST)

| <u>Testing Periods</u>   | <u>USOC</u> | <u>First Half Hour or Fraction Thereof</u> | <u>Each Additional Half Hour or Fraction Thereof</u> |
|--|-------------|--|--|
| Basic Time,<br>normally scheduled<br>working hours#  | SNOX+       | \$41.58 (I)                                | \$30.02 (I)  |
| Overtime,<br>outside of normally<br>scheduled working<br>hours on a scheduled<br>work day# | SNOX+       | 56.60*                                     | 45.04*   |
| Premium Time,<br>outside of scheduled<br>work day#   | SNOX+       | 71.61* (I)                                 | 60.05* (I)   |

PUBLIC SERVICE COMMISSION  
OF KENTUCKY  
EFFECTIVE

MAY 23 1995

PURSUANT TO 807 KAR 5.011,  
SECTION 9(1)

BY: Jordan C. Neal  
FOR THE PUBLIC SERVICE COMMISSION

# If more than one technician is involved with the same testing project, the total amount of time for all technicians involved will be aggregated prior to the distribution of time between the "First Half Hour or Fraction Thereof" and "Each Additional Half Hour or Fraction Thereof" rate categories.

\* A call-out of a Telephone Company employee at a time not consecutive with the employee's scheduled work period is subject to a minimum charge of four hours.

Issued: June 13, 1995

Effective: May 23, 1995

Deborah Nisch President, Cincinnati, Ohio  
Vice President  
Integrated Corporate Planning for

ACCESS SERVICE TARIFF  
PSCK No. 2

CINCINNATI BELL TELEPHONE COMPANY

1st Revised Page 567  
Cancels Original Page 567

13. Additional Engineering, Additional Labor and Miscellaneous Services (Cont'd)

13.3 Miscellaneous Services (Cont'd)

13.3.6 Provision of Access Service Billing Information

- (A) At the customer's request and at no charge, the customer may choose as the primary billing medium one of the following billing formats: standard paper magnetic tape or electronic data transmission which includes either T-TRAN or Network Data Mover (NDM™). (C)
- (B) At the option of the customer, and for additional charges, additional copies of the access bill vendor the customer service record will be provided in paper, magnetic tape, microfiche or electronic data transmission formats. (C)
- (C) Upon acceptance by the Telephone Company of an order for data transmission the Telephone Company will determine the period of time to implement the transmission of such material on an individual order basis. (C)
- (D) When magnetic tape is requested as the primary monthly bill, the Telephone Company does not require the customer to return previously supplied tapes. (N)
- (E) When electronic data transmission is requested as the primary monthly bill, the data may be transmitted at 56kbps for customer using T-TRAN, or 300 bps to 1.5 mbps for customer using NDM™. The customer will be responsible for facilities needed from the NDM electronic data transmission. These facilities may be purchased out of the Telephone Company's FGC 35 Access Services Tariff, Section 7. (N)
- (F) Unless otherwise specified by the customer, paper copies, microfiche copies, or magnetic tape will be sent via U.S. Mail service. However, at the customer's request, an alternative method may be negotiated with the Telephone Company. (N)
- (G) The customer may deem it necessary to request the Company to resend the access service billing information. Such a request, when not the result of Telephone Company error, will be subject to the same rates and charges as an original request for copies of access service billing information. (N)

PUBLIC SERVICE COMMISSION  
OF KENTUCKY  
EFFECTIVE

MAY 23 1995

PURSUANT TO 807 KAR 5:011,  
SECTION 9(1)

BY: Jordan C. Neal (F)  
FOR THE PUBLIC SERVICE COMMISSION

NDM™ is a trademark of Systems Center, Inc.

Issued: June 13, 1995

Effective: May 23, 1995

Deborah D. Ditch President, Cincinnati, Ohio  
Vice President  
Integrated Corporate Planning for

ACCESS SERVICE TARIFF  
PSCK No. 2

CINCINNATI BELL TELEPHONE COMPANY

1st Revised Page 568  
Cancels Original Page 568

13. Additional Engineering, Additional Labor and Miscellaneous Services (Cont'd)

13.3 Miscellaneous Services (Cont'd)

13.3.6 Provision of Access Service Billing Information (Cont'd)

(H) The rates and charges for the provision of Access Service Billing Information include a Nonrecurring Charge and a Monthly Rate and are as follows: (C)

|  | <u>Monthly Rate</u> | <u>Nonrecurring Charge</u> |     |
|--|---------------------|----------------------------|-----|
| (1) Provision of additional copies of standard billing detail and/or information in magnetic tape format |                     |                            | (C) |
| - per tape   | \$47.81             | \$ 75.14                   |     |
| (2) Electronic Data Transmission of billing detail to the customer's premises using T-TRAN or NDM™       |                     |                            |     |
| - per bill transmitted   | \$17.98             | \$300.56                   |     |
| (3) Additional copies of the access bill and/or customer service records in microfiche format            |                     |                            |     |
| - per page (or frame)  | \$ .0207            | \$225.42                   |     |
| (4) Additional copies of the access bill and/or customer service records in standard paper format        |                     |                            |     |
| - per page   | \$ .1852            | \$ 75.14                   | (C) |

PUBLIC SERVICE COMMISSION  
OF KENTUCKY  
EFFECTIVE

MAY 23 1995

PURSUANT TO 807 KAR 5:011,  
SECTION 9 (1)

BY: Jordan C. Neal  
FOR THE PUBLIC SERVICE COMMISSION

Issued: June 13, 1995

Effective: May 23, 1995

*Deborah A. Nisch*  
Vice President  
Integrated Corporate Planning for

President, Cincinnati, Ohio

13. Additional Engineering, Additional Labor and Miscellaneous Services (Cont'd)

13.3 Miscellaneous Services (Cont'd)

13.3.7 International Blocking Service (IBS) (N)

International Blocking Service (IBS) is an optional end user service that provides end office blocking of 011+ and 10XXX 011+ dialed calls. Originating 011+ and 10XXX or 10XXXX 011+ dialed calls from exchange lines provisioned with IBS will be blocked and routed to a recorded announcement. IBS is available to any Call Aggregator, Nonresidence (Business) and/or Residence service customer with exchange line side services that are subject to either the Single Line End User Common Line (EUCL) or Multiline Business EUCL rates. It is provided where facilities permit as specified in the National Exchange Carrier Association Inc., Tariff FCC No. 4.

The service (IBS) is available and may only be ordered on exchange line side services and only on a per line/trunk basis. No separate nonrecurring charge will apply for the installation of IBS when it is installed coincident with the initial installation of Telephone Company exchange service. A separate nonrecurring charge applies to IBS when it is installed subsequent to the initial installation of Telephone Company Exchange Service.

|   | <u>USOC</u> | Rate    |     |
|---|-------------|---------|-----|
| International Blocking Service<br>- Per Line or Trunk | RBVXC       | \$16.10 | (N) |

ACCESS SERVICE TARIFF  
PSC No. 2

CINCINNATI BELL TELEPHONE COMPANY

Original Page 569

14. (Reserved)

PUBLIC SERVICE COMMISSION  
OF KENTUCKY  
EFFECTIVE

MAR 3 1992

PURSUANT TO 807 KAR 5:011,  
SECTION 9 (1)

BY: *Glenn Keller*  
PUBLIC SERVICE COMMISSION MANAGER

Issued: February 7, 1992

Effective: March 3, 1992

*Robert E. Aigmon* for President, Cincinnati, Ohio

Vice President - Regulatory Affairs

ACCESS SERVICE TARIFF  
PSC No. 2

CINCINNATI BELL TELEPHONE COMPANY

Original Page 570

15. Rate Centers

This section lists Kentucky rate centers within the Cincinnati Market Area (LATA) .

ALEXANDRIA  
BOONE  
BUTLER  
COVINGTON  
FALMOUTH  
GLENCOE  
INDEPENDENCE  
WALTON  
WARSAW  
WILLIAMSTOWN

PUBLIC SERVICE COMMISSION  
OF KENTUCKY  
EFFECTIVE

MAR 3 1992

PURSUANT TO 807 KAR 5:011,  
SECTION 9 (7)

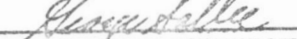
BY:   
PUBLIC SERVICE COMMISSION MANAGER

Issued: February 7, 1992

Effective: March 3, 1992

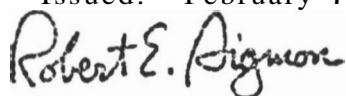

President, Cincinnati, Ohio

Vice President - Regulatory Affairs

ACCESS **SERVICE TARIFF**  
PSCK No. 2

CINCINNATI BELL TELEPHONE COMPANY

Original Page 571

16. Alarm Services

(N)

16.1 General

16.1.1 Nonrecurring Charges

A. Description of Charges

1. Initial charges associated with the installation of service and facilities. The Initial Charges apply as follows:

a. Per Local Channel

b. Per Channel Option including conditioning, signaling, alternate use arrangements and switching arrangements when installed subsequent to the initial installation of the associated channel. This charge also applies to change from one channel option to another.

2. Remises Charges

a. General

A Remises Visit charge applies when a visit is required by the Telephone Company to perform work necessitated by the customer's request for service as specified below.

b. Application of Remises Visit Charge

- (1) A Remises Visit charge applies per customer request for each different building on non-continuous property that is visited on the same date for the same service to connect, move, or change that service.
- (2) A Remises Visit charge applies in addition to all other rates and charges for services as specified in this or other applicable tariffs.
- (3) Charges for work requested that are not provided in this or other applicable tariffs, will be charged on the basis of estimated or actual costs incurred, unless otherwise specified.

PUBLIC SERVICE COMMISSION  
OF KENTUCKY  
EFFECTIVE

MAY 23 1995

PURSUANT TO 807 KAR 5:011,  
SECTION 9(1)

BY: Jordan C. Neel  
FOR THE PUBLIC SERVICE COMMISSION

(N)

Issued: June 13, 1995

Effective: May 23, 1995

*Deborah A. Niseth*  
Vice President  
Integrated Corporate Planning for Cincinnati, Ohio

ACCESS SERVICE TARIFF  
PSCK No. 2

CINCINNATI BELL TELEPHONE COMPANY

Original Page 572

16. Alarm Services (Cont'd)

(N)

16.1 General (Cont'd)

16.1.1 Nonrecurring Charges (Cont'd)

A. Description of Charges (Cont'd)

2. Premises Charges (Cont'd)

c. Non-Application of Remises Visit Charges

(1) Disconnects

(2) For a visit to a customer's premises where a service difficulty or trouble report results from customer-provided equipment or facilities. **However**, a maintenance of service charge as described in Section 13 applies.

(3) Any Telephone Company-initiated changes.

(4) Convert existing 900 Private Line channel service to a Alarm Series 3000 channel service.

d. Charges

PUBLIC SERVICE COMMISSION  
OF KENTUCKY  
EFFECTIVE

|               |         |
|---------------|---------|
| Remises Visit | \$58.39 |
|---------------|---------|

e. Maintenance and Repair

(1) This is the charge in Section 2d, 10c, of the General Exchange Tariff, PSCK No. 3. The rate is as follows:

First fifteen minutes or fraction thereof \$31.50

Each additional fifteen minutes or fraction thereof \$ 9.00

MAY 23 1995

PURSUANT TO 807 KAR 5:011,  
SECTION 9(1)

BY: Jordan C. Neal  
FOR THE PUBLIC SERVICE COMMISSION

B. Regulations

1. A move of an alarm service to a different building on noncontinuous property is considered a new connection.

2. A change from one type of alarm service to another is considered a new connection.

3. A change from half-duplex to duplex or two-wire to four-wire or vice versa is considered a new connection.

(N)

Issued: June 13, 1995

Effective: May 23, 1995

Deborah A. Nisch  
Vice President  
Integrated Corporate Planning for

President, Cincinnati, Ohio



ACCESS SERVICE TARIFF  
PSCK No. 2

CINCINNATI BELL TELEPHONE COMPANY

Original Page 573

16. Alarm Services (Cont'd)

(N)

16.1 General (Cont'd)

16.1.2 Service Configurations

A. Intraexchange

1. In the normal scope of service, intraexchange special access services furnished within the same central office serving area, one local channel is required to connect the serving central office to the customer premise.
2. When intraexchange special access service is furnished between customer locations in different central office serving areas, interoffice channels are required to connect the serving central offices. The number of interoffice channels required for a single special access service is one less than the total number of serving central offices. Within each central office serving area, one local channel is required to provide connection between the serving central office to the customer premise.

B. Interexchange

1. When special access service is furnished between customer locations in different exchange areas, interexchange channels are required to connect the rate centers of the exchange areas. The total number of interexchange channels required for a single special access service is one less than the total number of rate centers. Within each exchange area one local channel is required to connect the serving central office to the customer premise. If the serving central office is different from the rate center central office, an interoffice channel is also required to connect the serving central office and the rate center central office in each such exchange area. In addition, a channel terminal applies per rate center central office for each interexchange channel termination.
2. Each interexchange channel connected to a switching arrangement is considered as a separate channel for which the interexchange mileage is independently computed.

PUBLIC SERVICE COMMISSION  
OF KENTUCKY  
EFFECTIVE

MAY 23 1995

PURSUANT TO 807 KAR 5:011,  
SECTION 9 (1)

Y: Jordan C. Neel  
FOR THE PUBLIC SERVICE COMMISSION

(N)

Issued: June 13, 1995

Effective: May 23, 1995

*Deborah A. Nisch*  
President, Cincinnati, Ohio  
Vice President  
Integrated Corporate Planning for

ACCESS SERVICE TARIFF  
PSCK No. 2

CINCINNATI BELL TELEPHONE COMPANY

Original Page 574

16. Alarm Services (Cont'd)

(N)

16.1 General (Cont'd)

16.1.2 Service Configurations (Cont'd)

C. Types of Service Configurations

1. Two-Point Service

A two-point service connects two customer designated premises, or a customer designated premises and a serving office for a 3000 channel, either on a directly connected basis or through a hub where multiplexing functions are performed.

Example: Alarm Series 3000 Channel point to point service connecting two customer premises via the two customer premises are 10 miles from the customer designated premises.

PUBLIC SERVICE COMMISSION  
OF KENTUCKY  
EFFECTIVE

LC - Local Channel  
IC - Interoffice Channel  
SWC - Serving Wire Center

MAY 23 1995

PURSUANT TO 807 KAR 5:011,  
SECTION 9(1)

Applicable rate elements are:

- Local Channel (two applicable)
- Channel Mileage (1 section)

BY: Jordan C. Neal  
FOR THE PUBLIC SERVICE COMMISSION

(N)

Issued: June 13, 1995

Effective: May 23, 1995

*Reborah A. Nisch*  
President, Cincinnati, Ohio  
Vice President  
Integrated Corporate Planning for

ACCESS SERVICE TARIFF  
PSCK No. 2

CINCINNATI BELL TELEPHONE COMPANY

Original Page 575

16. Alarm Services (Cont'd)

(N)

16.1 General (Cont'd)

16.1.2 Service Configurations (Cont'd)

C. Types of Service Configurations (Cont'd)

2. Multipoint Service

Multipoint service connects three or more customer designated premises through a Telephone Company hub provided as multipoint service.

The channel between hubs (i.e., bridging locations) on a multipoint service is a mid-link. There is no limitation on the number of mid-links available with a multipoint service. However, when more than three mid-links in tandem are provided the quality of the overall service may be degraded.

Multipoint service utilizing a customized technical specifications package, in Section 7, will be provided when technically possible. If the Telephone Company determines that the requested characteristics for a multipoint service are not compatible, the customer will be advised and given the opportunity to change the order.

When ordering, the customer will specify the desired bridging hub(s). National Exchange Carrier Association Tariff FCC No. 4 identifies serving wire centers, hub locations and the type of bridging functions available.

Applicable Rate Elements are:

- Local Channel (One per customer-designated premises)
- Interoffice Channel (as applicable between each designated customer premises and the hub, and between hubs).
- Alternate Use Arrangements (when applicable).

PUBLIC SERVICE COMMISSION  
OF KENTUCKY (N)  
EFFECTIVE

MAY 23 1995

PURSUANT TO 807 KAR 5:011,  
SECTION 9(1)

BY: Jordan C. Neel  
FOR THE PUBLIC SERVICE COMMISSION

Issued: June 13, 1995

Effective: May 23, 1995

Reborah A. Nisch  
President, Cincinnati, Ohio  
Vice President  
Integrated Corporate Planning for

ACCESS SERVICE  
PSCK No. 2

CINCINNATI BELL TELEPHONE COMPANY

Original Page 576

16. Alarm Services (Cont'd)

(N)

16.1 General (Cont'd)

16.1.2 Service Configurations (Cont'd)

**Example:** Alarm Series 3000 Channel multipoint service connecting four customer premises via two customer premises via two customer specified bridging hubs.

LC - Local Channel  
IC - Interoffice Channel  
SWC - Serving Wire Center

Applicable rate elements are:

- Local Channel (4 applicable)
- Interoffice Channel (4 sections)

(N)

PUBLIC SERVICE COMMISSION  
OF KENTUCKY  
EFFECTIVE

MAY 23 1995

PURSUANT TO 807 KAR 5.011,  
SECTION 9 (1)

BY: Jordan C. Neal  
FOR THE PUBLIC SERVICE COMMISSION

Issued: June 13, 1995

Effective: May 23, 1995

*Deborah Nisch*  
President, Cincinnati, Ohio  
Vice President  
Integrated Corporate Planning for

ACCESS SERVICE TARIFF  
PSCK No. 2

CINCINNATI BELL TELEPHONE COMPANY

Original Page 577

16. Alarm Services (Cont'd)

16.1 General (Cont'd)

16.1.3 Mileage Measurements

A. Interexchange channels for Alarm Series 3000.

(N)

1. Two-Point Service

- a. The mileage is the airline distance between the rate centers of the service points. Airline mileages are computed mathematically, employing as a base a vertical (V) and a horizontal (H) coordinate for each rate center, as determined from its latitude and longitude location by use of appropriate map projection equations.
- b. Interexchange channel rates apply for each mile or fraction thereof.

2. Multi-Point Service

- a. Each interexchange channel connecting the rate centers of the exchange areas within which service is furnished is considered a separate channel for which airline mileage is independently computed. When the customer specifies the sequence in which rate centers are to be connected, the interexchange channel charges will be determined in that sequence. Otherwise, the interexchange channel charges will be based on whatever combination of airline mileages between rate centers produces the lowest total mileage charge.
- b. The airline distance between each pair of rate centers is determined in accordance with 16.1.3.A.1.a, above.

PUBLIC SERVICE COMMISSION  
OF KENTUCKY  
EFFECTIVE

MAY 23 1995

PURSUANT TO 807 KAR 5:011,  
SECTION 9(1)

BY: Jordan C. Neel  
FOR THE PUBLIC SERVICE COMMISSION

Issued: June 13, 1995

Effective: May 23, 1995

President, Cincinnati, Ohio

*Deborah A. Nisch*  
Vice President  
Integrated Corporate Planning for

ACCESS SERVICE TARIFF  
PSCK No. 2

CINCINNATI BELT. TELEPHONE COMPANY

Original Page 578

16. Alarm Services (Cont'd)

(N)

16.1 General (Cont'd)

16.1.3 Mileage Measurements (Cont'd)

B. Interoffice channel for Alarm Series 3000.

1. Two-Point Service

- a. The mileage is the airline distance between the serving central office buildings of the service points. Airline mileages are computed mathematically, employing as a base a vertical (V) and a horizontal (H) coordinate for each rate center, as determined from its latitude and longitude location by use of appropriate map projection equations.
- b. For intraexchange service, rates for interoffice channels are based on the airline mileage between **serving** central offices; for interexchange service, rates are based on the airline mileage between the serving central office and the rate center central office of the exchange.
- c. Interexchange channel rates apply for each mile or fraction thereof.

2. Multi-Point Service

PUBLIC SERVICE COMMISSION  
OF KENTUCKY  
EFFECTIVE

MAY 23 1995

PURSUANT TO 807 KAR 5.011,  
SECTION 9(1)

BY: Jordan C. Neal  
FOR THE PUBLIC SERVICE COMMISSION

a. Each interoffice channel connecting serving central offices **within** an exchange area is considered a separate channel for which airline mileage is independently computed. **When** the customer specifies the **sequence** in which **serving** central offices are to be connected, the interoffice channel charges will be determined in that sequence. Otherwise, the interoffice channel charges will be based on **whatever** combination or airline distance between serving central office produces the **lowest** total mileage charge.

- b. The airline distance between each pair of **serving** central offices is determined in accordance with 16.1.3.B.1.a, above.

(N)

Issued: June 13, 1995

Effective: May 23, 1995

*Deborah A. Nisch*  
President, Cincinnati, Ohio  
Vice President  
Integrated Corporate Planning for

CINCINNATI BELL TELEPHONE COMPANY

Original Page 579

MAY 23 1995

16. Alarm Services (Cont'd)

PURSUANT TO 807 KAR 5:011,  
SECTION 9(1)

(N)

16.1 General (Cont'd)

BY: Jordan C. Neal  
FOR THE PUBLIC SERVICE COMMISSION

16.1.4 Definitions

These are definitions in addition to those included in Section 2.6.

Central Office Termination

The term "Central Office Termination" as used in connection with special access service denotes that portion of a Central Office Connecting Circuit located in a Telephone Company Central Office which connects such system with either another central office termination, a local channel, an interoffice channel or an interexchange channel.

Channel Termination

The term "Channel Terminal" denotes that portion of a special access service required to terminate the interexchange channel.

Full-Duplex Service

The term "Full-duplex Service" denotes a service which provides for simultaneous transmission of signals in the same frequency spectrum in both directions.

Half-Duplex Service

The term "Half-duplex Service" denotes service which provides for transmission alternately in either direction or for transmission in one direction *only*.

Interexchange Channel

The term "Interexchange Channel" as used in connection with special access services denotes that portion of a through channel which connects different exchange areas in which stations or channel terminations in Telephone Company offices are located.

(N)

Issued: June 13, 1995

Effective: May 23, 1995

*Deborah A. Nisch*  
President, Cincinnati, Ohio  
Vice President  
Integrated Corporate Planning for

ACCESS SERVICE TARIFF

PSCK No. 2

PUBLIC SERVICE COMMISSION  
OF KENTUCKY  
EFFECTIVE

CINCINNATI BELL TELEPHONE COMPANY

Original Page 580

16. ~~Alarm Services~~ (Cont'd)

16.1 General (Cont'd)

16.1.4 Definitions (Cont'd)

MAY 23 1995

PURSUANT TO 807 KAR 5:011,  
SECTION 9(1)

BY: Jordan C. Neel  
FOR THE PUBLIC SERVICE COMMISSION

(N)

Interexchange Special Access Service

The term "Interexchange Private Line Service" denotes the special access service which connects different exchange areas in which stations or channel terminations in Telephone Company offices are located. This service includes the interexchange channel, channel terminals (interexchange), local channel(s) and/or central office terminations, and as required, interoffice channels.

Interoffice Channel

The term "Interoffice Channel" denotes that portion of a special access service which connects local channels which serve customers who are served from different central office buildings and, when used as part of an interexchange special access service, to connect an interexchange channel with a local channel(s).

Intraexchange Channel

The term "Intraexchange Channel" as used in connection with special access services denotes a channel which connects two or more station locations within an exchange area and is not connected to an interexchange channel. This service includes local channels and/or central office terminations, and as required, interoffice channels.

Local Channel

The term "Local Channel" as used in connection with special access service denotes that portion of a special access which connects a station with an interexchange channel or an interoffice channel, or which connects stations which are served from the same central office building.

Rate Center Central Office

The term "Rate Center Central Office" denotes the central office of a multioffice exchange that most closely identifies with the V and H coordinates used to determine interexchange channel mileage.

(N)

Issued: June 13, 1995

Effective: May 23, 1995

*Deborah A. Nisch*  
President, Cincinnati, Ohio  
Vice President  
Integrated Corporate Planning for



ACCESS SERVICE TARIFF  
PSCK No. 2

CINCINNATI BELL TELEPHONE COMPANY

Original Page 581  
PUBLIC SERVICE COMMISSION  
OF KENTUCKY  
EFFECTIVE

16. Alarm Services (Cont'd)

16.2 Service Description

16.2.1 Alarm Services

A. Types and Description

1. General

- a. Alarm Series 3000 services are for alarm services only and include voice grade channels for data transmission of approximate bandwidth of 300-3000 Hz for half-duplex or duplex operation. Duplex service is furnished on an entire channel, or on a portion thereof, where facility conditions permit.
- b. Channels are furnished on a tw-point or multipoint basis to the extent specified below. The number of stations that may be connected and the distance over which satisfactory transmission is possible may be limited by operating and transmission factors.
- c. Conditioning options required to provide certain types of transmission performance on Alarm Series 3000 Channels are specified in Section 3.3.
- d. Alarm Series 3000 Channels may be arranged for alternate use as specified in Section 3.3.

2. Types

a. With reference to the following descriptions:

1. "Effective tw-vire facilities" may be composed of tw-vire metallic and/or four-vire metallic and/or carrier segments; "four-vire facilities" are composed entirely of four-vire metallic and/or carrier segments.
2. The 1000 Hz loss objective range specified refers to the total channel offering (end-to-end) and indicates that the engineered objective loss will fall within that range at the discretion of the Telephone Company depending upon available facilities and the applicability of short-haul or long-haul engineering designs. These specifications do not include gains or losses present in customer provided equipment.

Issued: June 13, 1995

Effective: May 23, 1995

*Reborah A. Nisch*  
President, Cincinnati, Ohio  
Vice President  
Integrated Corporate Planning for

(N)

(N)

ACCESS SERVICE TARIFF  
PSCK No. 2

CINCI

PUBLIC SERVICE COMMISSION  
OF KENTUCKY  
EFFECTIVE

Original Page 582

16. ~~Alarm Services~~ (Cont'd)

16.2 Service Description (Cont'd)

16.2.1 Alarm Services (Cont'd)

A. Types and Description (Cont'd)

2. Types (Cont'd)

3. The Telephone Company reserves the right to revise these objectives and other technical parameters as described herein in accord with FCC Tariff No. 35. Section 7.

b. Type 3001 - A two-wire interface with effective two-wire facilities or a four-wire interface with four-wire facilities engineered for a 1000 Hz loss objective of 16 Db; half duplex or full duplex operation; for two-point or multipoint service; normally suitable for audio tone protective relaying.

c. Type 3002 - A two-wire interface with effective two-wire facilities or a four-wire interface with four-wire facilities engineered for a 1000 Hz loss objective of 16 Db; half-duplex or full duplex operation; for two-point or multipoint; normally suitable for data transmission.

MAY 23 1995

PURSUANT TO 807 KAR 5011,  
SECTION 9(1)

BY: Jordan C. Neal  
FOR THE PUBLIC SERVICE COMMISSION

(N)

(N)

Issued: June 13, 1995

Effective: May 23, 1995

*Deborah A. Nisch*  
President, Cincinnati, Ohio  
Vice President  
Integrated Corporate Planning for

ACCESS SERVICE TARIFF  
PSCK No. 2

CINCINNATI BELL TELEPHONE COMPANY

Original Page 583  
PUBLIC SERVICE COMMISSION  
OF KENTUCKY  
EFFECTIVE

16. Alarm Services (Cont'd)

16.3 Rate Classification and Rates

16.3.1 Types of Regulations and Charges

A. Regulations

1. Type 3001

When equipped with Type C6 conditioning as specified in Section 16.1.2 these channels are designed specifically for use as audio tone protective relaying channels. An 8dB option is available subject to local channel restriction.

2. Type 3002

- a. Channels are not suitable for the transmission of direct current pulses.
- b. The number of stations that may be connected and the distance over which satisfactory transmission is possible may be limited by operating and transmission factors.
- c. Type C1 conditioning as described in 16.1.2 is included in the channel charge for alarm series type services 3002 channels.
- d. Channels are not suitable for switching or tandem operations to the public switched network or other special access services.
- e. When used for data transmission, signal conditioning data set equipment is required to condition signals generated by apparatus furnished by the customer to signals suitable for transmission on a channel and to condition signals received from such a channel to signals for delivery to apparatus furnished by the customer. Signal conditioning data sets may be provided by the customer when connected through the local facility provided by the Telephone Company as part of the alarm service.

MAY 23 1995

PURSUANT TO 807 KAR 5:011,  
SECTION 9(1)

BY: Jordan C. Neel  
FOR THE PUBLIC SERVICE COMMISSION

(N)

(N)

Issued June 13, 1995

Effective: May 23, 1995

Barbara A. Neish  
Vice President  
Integrated Corporate Planning for

President, Cincinnati, Ohio

ACCESS SERVICE TARIFF  
PSCK No. 2

CINCINNATI BELL TELEPHONE COMPANY

Original Page 584

16. Alarm Services (Cont'd)

(N)

16.3 Rate Classification and Rates (Cont'd)

16.3.1 Types of Regulations and Charges (Cont'd)

B. Rates

1. Intraexchange

|                                   | <u>Rate<br/>Per Month</u> |
|-----------------------------------|---------------------------|
| a. Recurring                      |                           |
| (1) Local Channel, each           |                           |
| (a) Type 3001                     |                           |
| Half-duplex                       | \$15.18                   |
| Full-duplex                       | 29.50                     |
| (b) Type 3002                     |                           |
| Half-duplex                       | 15.18                     |
| Full-duplex                       | 32.37                     |
| (2) Interoffice Channel, per mile |                           |
| (a) Type 3001, 3002               |                           |
| <b>Half-duplex</b>                |                           |
| First mile                        | 16.50                     |
| Each additional mile              | 4.66                      |
| <b>Full-duplex</b>                |                           |
| First mile                        | 16.50                     |
| Each additional mile              | 9.26                      |

Initial  
Charge

PUBLIC SERVICE COMMISSION  
OF KENTUCKY  
EFFECTIVE

b. Nonrecurring

|                       |          |
|-----------------------|----------|
| (1) Per Local Channel |          |
| (a) Type 3001         |          |
| Half-duplex           | \$108.91 |
| Full-duplex           | 124.43   |
| (b) Type 3002         |          |
| Half-duplex           | 108.91   |
| Full-duplex           | 124.43   |

MAY 23 1995  
PURSUANT TO 807 KAR 5011,  
SECTION 9(1)  
BY: Jordan C. Neal 108.91  
FOR THE PUBLIC SERVICE COMMISSION 124.43

(N)

Issued: June 13, 1995

Effective: May 23, 1995

*Norah A. Nisch*  
President, Cincinnati, Ohio  
Vice President  
Integrated Corporate Planning for

ACCESS SERVICE TARIFF  
PSCK No. 2

CINCINNATI BELL TELEPHONE COMPANY

Original Page 585

16. Alarm Services (Cont'd)

PUBLIC SERVICE COMMISSION (N)  
OF KENTUCKY  
EFFECTIVE

16.3 Rate Classification and Rates (Cont'd)

16.3.1 Types of Regulations and Charges (Cont'd)

MAY 23 1995

PURSUANT TO 807 KAR 5:011,  
SECTION 9(1)

BY: Jordan C. Neal  
FOR THE PUBLIC SERVICE COMMISSION

B. Rates (Cont'd)

2. Interexchange

Rate  
Per Month

a. Recurring

|                                     |         |
|-------------------------------------|---------|
| (1) Interexchange Channel, per mile | \$ 3.11 |
| (2) Channel Terminal, per terminal  | 38.81   |
| (3) Local Channel, each             |         |
| (a) Type 3001                       |         |
| Half-duplex                         | 25.47   |
| Full-duplex                         | 30.42   |
| (b) Type 3002                       |         |
| Half-duplex                         | 31.40   |
| Full-duplex                         | 37.43   |
| (4) Interoffice Channel, per mile   |         |
| (a) Type 3001, 3002                 |         |
| Half-duplex                         |         |
| First mile                          | 18.63   |
| Each additional mile                | 7.65    |
| Full-duplex                         |         |
| First mile                          | 21.74   |
| Each additional mile                | 9.20    |

b. Nonrecurring

|                       |        |
|-----------------------|--------|
| (1) Per Local Channel |        |
| (a) Type 3001         |        |
| Half-duplex           | 108.91 |
| Full-duplex           | 124.43 |
| (b) Type 3002         |        |
| Half-duplex           | 108.91 |
| Full-duplex           | 124.43 |

3. Removal of Load-Coils and/or Bridge-Tap

Per Cable Opening 653.10 (N)

Issued: June 13, 1995

Effective: May 23, 1995

*Deborah A. Nisch*  
President, Cincinnati, Ohio  
Vice President  
Integrated Corporate Planning for

ACCESS SERVICE TARIFF  
PSCK No. 2

CINCINNATI BELL TELEPHONE COMPANY

Original Page 586

16. ~~Alarm Services~~ (Cont'd)

(N)

16.3 Bate Classification and Rates (Cont'd)

16.3.3 Conditioning

Series 3000

1. Type and Description

Conditioning for channels of voice grade is furnished as follows:

Types C1 - the envelope delay distortion shall not exceed:  
between 1000 and 2400 Hertz, a maximum  
difference of 1000 microseconds.  
- the loss deviation rith frequency (from 1000  
Hertz reference) shall not exceed:  
between 1000 and 2400 Hertz, -1db to +3db  
between 300 and 3700 Hertz, -2db to +6db  
(+means more loss)

Type C2 - the envelope delay distortion shall not exceed:  
between 1000 and 2600 Hertz, a maximum  
difference of 500 microseconds.  
between 600 and 2600 Hertz, a maximum  
difference of 1500 microseconds.  
between 500 and 2800 Hertz, a maximum  
difference of 3000 microseconds.  
- the loss deviation vith frequency (from 1000  
Hertz reference) shall not exceed:  
between 500 and 2800 Hertz, -1db to +3db  
between 300 and 3000 Hertz, -2db to +6db  
(+ means more loss)

(N)

PUBLIC SERVICE COMMISSION  
OF KENTUCKY  
EFFECTIVE

MAY 23 1995

PURSUANT TO 807 KAR 5.011,  
SECTION 9(1)

BY: Jordan C. Neal  
FOR THE PUBLIC SERVICE COMMISSION

Issued: June 13, 1995

Effective: May 23, 1995

*Deborah Nisch*  
President, Cincinnati, Ohio  
Vice President  
Integrated Corporate Planning for

16. Alarm Services (Cont'd)

(N)

16.3 Rate Classification and Rates (Cont'd)

16.3.3 Conditioning (Cont'd)

1. Type and Description (Cont'd)

- Type C4 - the envelope delay distortion shall not exceed:  
between 1000 and 2600 Hertz, a maximum difference of 300 microseconds.  
between 800 and 2800 Hertz, a maximum difference of 500 microseconds.  
between 600 and 3000 Hertz, a maximum difference of 1500 microseconds.  
between 500 and 3000 Hertz, a maximum difference of 3000 microseconds.  
- the loss deviation with frequency (from 1000 Hertz reference) shall not exceed:  
between 500 and 3000 Hertz, -2db to +3db  
between 300 and 3200 Hertz, -2db to +6db  
(+ means more loss)

Type C6 - Audio Tone Protective Relaying Channel Conditioning

Audio Tone Protective Relaying Channel Conditioning for Type 3001 channels is furnished as follows:

PUBLIC SERVICE COMMISSION  
OF KENTUCKY  
EFFECTIVE

MAY 23 1995

PURSUANT TO 807 KAR 5:011,  
SECTION 9(1)

BY: Jonathan C. Neal  
FOR THE PUBLIC SERVICE COMMISSION

These channels may be one-way, effective two-wire for unidirectional operation or two-way, effective four-wire for bidirectional operation and may be ordered in two-point or multipoint configurations terminating in either Telephone Company provided or customer provided equipment. The standard circuit net loss of a channel is 16 db at 1004 Hz. As an option, however a channel having a net loss of 8 db is available upon customer request subject to the stipulation that the loops in each receive leg of the normally available local loop (including loop loss from the serving central office, high voltage protection transformer loss, circuit termination loss) does not exceed 8 db.

- the envelope delay distortion shall not exceed: 2000 microseconds between 800 and 2600 Hz.

(N)

Issued: June 13, 1995

Effective: May 23, 1995

Deborah A. Nisch President, Cincinnati, Ohio  
Vice President  
Integrated Corporate planning for

ACCESS SERVICE TARIFF  
PSCK No. 2

CINCINNATI BELL TELEPHONE COMPANY

Original Page 588

16. ~~Alarm Services~~ (Cont'd)

16.3 Bate Classification and Bates (Cont'd)

16.3.3 Conditioning (Cont'd)

1. Type and Description (Cont'd)

Type C6 - Audio Tone Protective Relaying Channel Conditioning (Cont'd)

- the loss deviation with frequency (from 1004 Hz reference) shall not exceed:  
between 300 - 3000 Hertz, -2db to +6db  
between 500 - 2800 Hertz, -1db to +3db
- the resistance unbalance of the local channel cable pairs will be 1 percent or less.

Type D1 - High Performance Data Conditioning

High Performance Data Conditioning for Type 3002 Channel is furnished as follows:

Type 01 - For a two-point channel not arranged for switching

- Certain data transmission characteristics necessary for high performance data transmission cannot be assured on all facilities generally available for data transmission. However, Type 3002 voice grade tw-point channels may be specially arranged to provided for the following technical parameters at the request of the customer:

- **Signal to C-Notched Noise Ratio** 28db
- **Nonlinear distortion:**
  - (a) signal to second order distortion 35db
  - (b) signal to third order distortion 40db

PUBLIC SERVICE COMMISSION  
OF KENTUCKY  
EFFECTIVE

MAY 23 1995

PURSUANT TO 807 KAR 5011,  
SECTION 9(1)

BY: Jordan C. Neal  
FOR THE PUBLIC SERVICE COMMISSION

Issued: June 13, 1995

Effective: May 23, 1995

Deborah Nisch President, Cincinnati, Ohio  
Vice President  
Integrated Corporate Planning for

(N)



ACCESS SERVICE TARIFF  
PSCK No. 2

CINCINNATI BELL TELEPHONE COMPANY

Original Page 589

16. Alarm Services (Cont'd)

16.3 Rate Classification and Rates (Cont'd)

16.3.3 Conditioning (Cont'd)

1. Type and Description (Cont'd)

Type D1 - High Performance Data Conditioning (Cont'd)

Type 01 - (Wt'd)

When the channel equipped with this conditioning is utilized for voice communications, the Telephone Company does not undertake to represent that the channel will be suitable for such voice transmission.

When, at the request of the customer, a channel is equipped with high performance data conditioning in accordance with the specifications preceding, conditioning charges apply as set forth in 16.3.2C2. following.

)

(N)

PUBLIC SERVICE COMMISSION  
OF KENTUCKY  
EFFECTIVE

MAY 23 1995

PURSUANT TO 807 KAR 5.011,  
SECTION 9(1)

BY: Jonathan C. Neel  
FOR THE PUBLIC SERVICE COMMISSION

Issued: June 13, 1995

Effective: May 23, 1995

Deborah H. Neesh  
Vice President Resident, Cincinnati, Ohio  
Integrated Corporate Planning for

ACCESS SERVICE TARIFF  
PSCK No. 2

CINCINNATI BELL TELEPHONE COMPANY

Original Page 590

16. ~~Alarm Services~~ (Cont'd)

(N)

16.3 Bate Classification and Bates (Cont'd)

16.3.3 Conditioning (Cont'd)

2. Rates (Series 3000)

Type C1 conditioning is included in the basic channel charge

|   | <u>Initial Charge(1)</u> | <u>Bate Per Month</u> |
|---|--------------------------|-----------------------|
| a. Type C2, per point                             | \$ 54.45                 | \$10.93               |
| b. Type C4, per point                             | \$ 54.4s                 | \$13.05               |
| c. Type C6, per point                             | \$ 54.45                 | \$20.18               |
| d. Type D1, per channel                           | \$108.91                 | \$20.01               |
| On a two-point channel not arranged for switching |                          |                       |

(1) This Initial Charge applies only when conditioning is added or changed subsequent to the initial installation of the associated channel.

(N)

PUBLIC SERVICE COMMISSION  
OF KENTUCKY  
EFFECTIVE

MAY 23 1995

PURSUANT TO 807 KAR 5.011.  
SECTION 9(1)

BY: Golden C. Neal  
FOR THE PUBLIC SERVICE COMMISSION

Issued: June 13, 1995

Effective: May 23, 1995

*Norah A. Nisch* Resident, Cincinnati, Ohio  
Vice President  
Integrated Corporate Planning for



LAN Advantage Frame Relay Service

(N)

17.1 Service Description

LAN Advantage Frame Relay Service known as Frame Relay is a packet network that permits the transmission of data at speeds of 56 Kbps, 64 Kbps, 112 Kbps, 128 Kbps, 384 Kbps, 768 Kbps and 1.536 Mbps using Permanent Virtual Connections (PVCs).

PVCs refers to as a permanent, software defined communication path established through a frame or packet network. The connection is analogous to a dedicated wire route. Frames or packets are routed through the connections.

When in operation, customer premises equipment (CPE), such as routers, encapsulate arriving data into variable length frames. These frames contain information identifying which PVC in the network should be used to forward the frame to the proper destination. The CPE then sends the frame into the Frame Relay network. The Frame Relay Switch reads identifying the information routes the frame to the proper destination based on a pre-established PVC.

Frame Relay Service conforms to Consultative Committee for International Telegraph and Telephone (CCITT) and American National Standards Institute (ANSI) publications T1.602, T1.606, T1.617, and T1.618.

17.2 Service Provisioning

LAN Advantage Frame Relay Service known as Frame Relay is a transport service that facilitates the exchange of variable length information units (frames) between end customer connections by way of assigned Permanent Virtual connections (PVCs).

Frame Relay also ensures network efficiency by means of the Committed Information Rate (CIR). Frame Relay is offered at CIR using 0% to 100% of the physical interface speed. The CIR specifies the percentage of the physical rate that is guaranteed to go through the network. CIR at 100% means that all traffic sent to the network is guaranteed to go through the network. The other is marked as Discard Eligible and will be sent through the network as space is available. CIR at 0% means that all data transmitted to the network is relying on the extra space available in the network. Because of the nature of data traffic, space will generally become available, but it may take some retransmission over the network

(N)

17. LAN Advantage Frame Relay Service (Cont'd)

17.2 Service Provisioning (Cont'd)

Variable frame length capability is useful in communications between synchronous (N)

Local Area Networks (LAN) and for transport of synchronous data traffic. Frame Relay is capable of handling the requirements of bursty data sources because of the ability of the service to allocate additional bandwidth when not in use by other sources.

CBT does not undertake to originate data, but offers the use of its service components, where available, to customers for the purpose of transporting customer originated data.

Frame Relay is provided to the customer in the form of the Frame Relay User-to-Network Interface (UNI) Port with Access Line, or Frame Relay UNI Port Only, Frame Relay Network-to-Network (NNI) Port only, and Permanent Virtual Connections. The Frame Relay Access Line forms the component which provides the customer access to the Customer's serving wire center and interoffice transport from the customer's serving wire center to the Frame Relay Switch. The Frame Relay Access line is provided for use only with Frame Relay Service. The Frame Relay UNI and NNI Port Only are provided for Digital and High Capacity connections to the network supporting Frame Relay Service. The Digital and High Capacity connections are available from Section 7.

PVCs are provisioned on either 56 Kbps, 64 Kbps, 112 Kbps, 128 Kbps, 384 Kbps, 768 Kbps and 1.536 Mbps ports, depending upon the customer's networking requirements. The actual throughput of aggregated PVC bandwidths in use at the same time on the same port cannot exceed the port speed. Since all PVCs need not be in use at the same time, it is possible for the total bandwidth of all PVCs associated with one Frame Relay Access Line to exceed the bandwidth of that Frame Relay Access Line. This relationship is referred to as over-subscription and when this occurs, there can be no guarantee that the bandwidth defined for that PVC will be available at any point in time. Bandwidth refers to the sum of Committed Information Rate (CIR) and Excess Information Rate (EIR). The CIR is ordered and billed. EIR equals the bit rate of the access line minus the CIR, except when connecting to an NNI, where the EIR is specified by the customer.

No PVC can have a greater bit rate than the bit rate of the associated access line

17. LAN Advantage Frame Relay Service (Cont'd)

17.2 Service Provisioning (Cont'd)

A customer subscribing to a Frame Relay port or port with access line will be referred to as the Controller of the Frame Relay Port. A customer may request data transmission capability to another customer. Both customers must have a Frame Relay Access Line and Frame Relay Port. The Controller of each Frame Relay Access Line that says 'ordering PVC's' must have written permission from the Controller(s) of each of the Frame Relay Access Lines to which a PVC is requested.

(N)

Frame Relay Port and PVC may be ordered independently and can have different customers as Controllers.

Frame Relay Service is available only where facilities and conditions permit.

17.3 Undertaking of the Telephone Company

In addition to the general regulations described in Section 2, when a customer orders a PVC which is relayed to other Local Exchange Carriers, Interexchange Carriers or other Frame Relay networks, the Telephone Company will provide assistance in establishing this PVC.

CBT has the service responsibility up to and including the demarcation point.

17.4 Obligations of the Customer

In addition to the general regulations described in Section 2, the following regulation will also apply.

The customer shall be responsible for obtaining permission for CBT employees to enter the premises of the customer at any reasonable hour for the purpose of installing, inspecting, repairing or upon termination of the service, removing the components of CBT.

The customer, upon request, shall furnish such information as may be required to permit CBT to design and maintain the Frame Relay Service it offers and to assure that the service arrangement is in compliance with the regulations contained herein.

It shall be the responsibility of the customer to ensure the continuing compatibility of the customer provided equipment that is used in conjunction with the Frame Relay Service.

(N)

17. LAN Advantage Frame Relays" Service (Cont'd)

17.5 Rate Regulations

Regulations in this section are applicable to Frame Relay Service and are in addition to regulations in other sections of the tariff.

Frame Relay Service optional payment plan (OPP) and minimum period charge is specified in 7.4.9.

When PVCs and CIRs per Kilobit are added to existing Frame Relay Service, the minimum period for the added PVCs is coterminous to the payment plan.

Frame Relay will be available 24 hours per day, 7 days per week, except for preventive maintenance, enhancements, and/or repair. CBT reserves the right to perform these tasks as needed, on off peak hours, generally on Sundays from 2:00 a.m. to 6:00 a.m.

Frame Relay Service consist of the following Rate Elements:

(A) Frame Relay UNI Port and Access Line

A monthly rate based on the speed of the port connection (i.e., 56 Kbps, 64 Kbps, 112 Kbps, 128 Kbps, 384 Kbps, 768 Kbps. or 1.536 Mbps), apply per port for each physical connection to the network supporting Frame Relay Service.

(B) Frame Relay UNI or NNI Port only

A monthly rate based on the speed of the port connection (i.e. 56 Kbps. 64 Kbps. or 1.536 Mbps). apply per port for each Frame Relay Access Line to the network supporting Frame Relay Service.

(C) Frame Relay PVC and CIR

A monthly rate apply for each PVC and for each CIR/Kilobit.

(N)

17 LAN Advantage Frame Relay Service (Cont'd)  
17.5 Rate Regulations (Cont'd)

1)

Frame Relay Service rate application is as follows:

- (A) A customer may access Frame Relay Service via a Frame Relay Access Line or via Telephone Company provided digital access facilities offered under Section 7. If a customer utilizes a special access line to access Frame Relay Service, the associated regulations, rates and charges for such facilities shall apply in addition to the rates and charges associated with the Frame Relay Service rate elements.
- (B) A customer utilizing special access facilities to access Frame Relay Service would incur the monthly rate associated with the Frame Relay UNI or NNI Port Only charge set forth under 17.6.B or 17.6.C respectively for standard arrangements. The UNI Port provides for a user to carrier connection; the NNI Port provides for a carrier-to-carrier connection.
- (C) The Frame Relay Access Line and PVC may be ordered and billed independently and can have different Controllers, as discussed under 17.2. A request by one customer to discontinue a PVC does not result in the disconnection of the Frame Relay Access Line may authorize a disconnect of that line.

( )



ACCESS SERVICE TARIFF  
PSCK No. 2

CINCINNATI BELL TELEPHONE COMPANY

1st Revised Page 597  
Cancels Original Page 597

17. LAN Advantage Frame Relay Service (Cont'd)

17.6 Rates and Charges

(A) Frame Relay UNI Port and Access Line, each

|            | USOC  | Month-to-<br>Month | 36<br>Month | 60<br>Month |
|------------|-------|--------------------|-------------|-------------|
| 56 Kbps    | FEZfZ | \$115.00           | \$110.00    | \$105.00    |
| 64 Kbps    | FEZAZ | \$115.00           | \$110.00    | \$105.00    |
| 112 Kbps   | FEZGZ | \$150.00           | \$140.00    | \$130.00    |
| 128 Kbps   | FEZBZ | \$150.00           | \$140.00    | \$130.00    |
| 384 Kbps   | FEZCZ | \$485.00           | \$475.00    | \$465.00    |
| 768 Kbps   | FEZDZ | \$515.00           | \$505.00    | \$495.00    |
| 1.536 Mbps | FEZEZ | \$545.00           | \$535.00    | \$525.00    |

CIR/Kilobit

|            |       |         |         |         |
|------------|-------|---------|---------|---------|
| 56 Kbps    | FEZFC | \$ .50  | \$ .50  | \$ .50  |
| 64 Kbps    | FEZAC | .50     | .50     | .50     |
| 112 Kbps   | FEZGC | .35     | .35     | .35     |
| 128 Kbps   | FEZBC | .35     | .35     | .15     |
| 384 kbps   | FEZ   | .15     | .15     | .15     |
| 768 Kbps   | FEZDC | .10     | .10     | .10     |
| 1.536 Mbps | FEZEC | .05     | .05     | .05     |
| Each PVC   | PVKXZ | \$ 1.25 | \$ 1.25 | \$ 1.25 |

(B) Frame Relay UNI Port Only, each

|            |       |          |          |          |
|------------|-------|----------|----------|----------|
| 56 Kbps    | FSZFZ | \$ 60.00 | \$ 50.00 | \$ 40.00 |
| 64 Kbps    | FSZAZ | \$ 60.00 | \$ 50.00 | \$ 40.00 |
| 1.536 Mbps | FSZEZ | \$450.00 | \$440.00 | \$430.00 |

CIR/Kilobit

|            |       |         |         |             |
|------------|-------|---------|---------|-------------|
| 56 Kbps    | FSZFC | \$ .50  | \$ .50  | \$ .50      |
| 64 Kbps    | FSZAC | .50     | .50     | .50         |
| 1.536 Mbps | FSZEC | .05     | .05     | .05         |
| Each PVC   | PVKXZ | \$ 1.25 | \$ 1.25 | \$ 1.25 (C) |

(C) Frame Relay NNI Port Only, each

|            |       |           |         |             |
|------------|-------|-----------|---------|-------------|
| 56 Kbps    | NN7FZ | \$ 60.00  | \$50.00 | \$40.00     |
| 64 k-p6s   | NN7AZ | 60.00     | 50.00   | 40.00       |
| 1.536 Mbps | PVKXZ | 450.00    | 440.00  | 430.00      |
| Each PVC   |       | \$ 1.25\$ | 1.25    | \$ 1.25 (C) |

18. Rate Zone Wire Centers

(N)

18.1 General

This section contains a list of each wire center that has been assigned to a rate zone. Rate zones are applicable to the services specified in Sections 6.7.5 and 7.4.3. This table lists by study area wire centers assigned to Rate Zones 1, 2, and 3.

| <u>Rate Zone</u> | <u>Wire Center Zone Assignments</u><br>CLLI | <u>Wire Center Name</u> |
|------------------|---|-------------------------|
| 1                | CNCNOHWS                                    | WEST SEVENTH ST.        |
| 2                | CNCNOHAV                                    | AVONDALE                |
| 2                | CVTNKYCN                                    | COVINGTON               |
| 2                | RILTOHCS                                    | CRESCENTVILLE           |
| 2                | EVDLOHEV                                    | EVENDALE                |
| 2                | FLRNKYFL                                    | FLORENCE                |
| 2                | GLDLOHGD                                    | GLENDALE                |
| 2                | HMTNOHMM                                    | HAMILTON                |
| 2                | KRGMOHNO                                    | MONTGOMERY              |
| 2                | RSMYOHRO                                    | ROSSMOYNE               |
| 3                | ALXNKYAL                                    | ALEXANDRIA              |
| 3                | BATVOHBA                                    | BATAVIA                 |
| 3                | BETHO[IBE                                   | BETHEL                  |
| 3                | BURLKYBN                                    | BURLINGTON              |
| 3                | BTLRKYBR                                    | BUTLER                  |
| 3                | CNCNOHCD                                    | COVEDALE                |
| 3                | CHGVOHCG                                    | CHERRY GROVE            |
| 3                | CHVTOHCH                                    | CHEVIOT                 |
| 3                | CRTDKYCT                                    | CRITTENDEN              |
| 3                | FRFDOHFF                                    | FARFIELD                |
| 3                | FLM(M(YFM                                   | FALMOUTH                |
| 3                | FFFHKYFR                                    | FORT THOMAS             |
| 3                | GLOCKYGC                                    | GLENCOE                 |
| 3                | GRSBOHGR                                    | GROESBECK               |
| 3                | GSHNOHGS                                    | GOSHEN                  |
| 3                | CNCNOHHP                                    | HYDE PARK               |
| 3                | HRSNOHHR                                    | HARRISON                |
| 3                | HMLTOHHT                                    | HAMLET                  |
| 3                | CNCNOHWW                                    | HARTWELL                |
| 3                | INDPKYIN                                    | INDEPENDENCE            |
| 3                | LVLDOHLO                                    | LOVELAND                |
| 3                | LKPKKYLP                                    | LAKESIDE PARK           |
| 3                | CNCNOHMA                                    | MADISONVILLE            |
| 3                | MLFROHMF                                    | MILFORD                 |

(N)

18. Rate Zone Wire Centers (Cont'd)

(N)

18.1 General (Cont'd)

Wire Center Zone Assignments (Cont'd)

| Rate Zone | CLL #     | Wire Center Name |
|-----------|-----------|------------------|
| 3         | MHTOHMH   | MOUNT HEALTHY    |
| 3         | MMTPOHMM  | MIAMI            |
| 3         | CNCNOHMW  | MOUNT WASHINGTON |
| 3         | NWMLCHNE  | NEWTONSVILLE     |
| 3         | GRHLOHNG  | NORTH GREENHILLS |
| 3         | NWMDOHR   | NEW RICHMOND     |
| 3         | CNCNOHNS  | NORTHSIDE        |
| 3         | NRWDOHNW  | NORWOOD          |
| 3         | CNCNOHPH  | PRICE HILL       |
| 3         | RELYOHRE  | REILLY           |
| 3         | STBROHSB  | ST. BERNARD      |
| 3         | SHNDOHSH  | SHANDON          |
| 3         | SVMLQ[ism | SEVEN MILE       |
| 3         | CNCNO[ISP | SAYLOR PARK      |
| 3         | TBSCOHTO  | TOBASCO          |
| 3         | UN[NKYUN  | UNION            |
| 3         | VLBGOHWB  | WILLIAMSBURG     |
| 3         | WCHSOHWC  | WEST CHESTER     |
| 3         | CNCNOHWD  | WESTWOOD         |
| 3         | WLTNKYWL  | WALTON           |
| 3         | WRSWKYWR  | WARSAW           |
| 3         | WLTWKYWT  | WILLIAMSTOWN     |

(N)

ACCESS SERVICE TARIFF  
 PSCK No. 2

CINCINNATI BELL TELEPHONE COMPANY

Original Page 600

19. Unbundled Network Elements (UNE's)\*

(N)

19.1 Unbundled Network Element Rates

19.1.1 - Central Office Rate Bands

| <u>Band 1</u> | <u>Band 2</u> | <u>Band 3</u> |
|---------------|---------------|---------------|
| Covington     | Alexandria    | Butler        |
| Florence      | Burlington    | Crittenden    |
| Ft. Thomas    | Independence  | Falmouth      |
| Lakeside Park | Union         | Glencoe       |
|               | Walton        | Warsaw        |
|               |               | Williamstown  |

19.2 CBT UNE Rate Elements

19.2.1 - Transport and Termination

|  | <u>Price Unit</u>                 | <u>Final Rate</u>          |
|--|-----------------------------------|----------------------------|
| A. End Office Local Termination                                  | Per Msg                           |                            |
| B. Tandem Switching  | Per Msg/ Per MOU                  | \$ 0.002114                |
| C. Tandem Transport Facility Mileage                             | Per Msg/Per MOU<br>Per MOU / Mile | \$ 0.001266<br>\$ 0.000049 |
| D. Dedicated Transport - See Interoffice Transmission Facilities |                                   |                            |

19.2.2 - BLV/BLVI Traffic Transport and Termination

|   |          |         |
|---|----------|---------|
| A. Busy Line Verification (BLV)   | Per Call | \$ 1.31 |
| B. Busy Line Verification Interrupt (BLVI)<br>(in addition to BLV charge) | Per Call | \$ 1.57 |

19.1.3 - Transit Service

|                                      |                         |                           |
|--------------------------------------|-------------------------|---------------------------|
| A. Tandem Switching                  | Per MOU                 | \$ 0.002001               |
| B. Tandem Transport Facility Mileage | Per MOU<br>Per MOU/Mile | \$ 0.00006<br>\$ 0.000117 |

PUBLIC SERVICE COMMISSION  
 OF KENTUCKY  
 EFFECTIVE

JUL 03 2003

\* Unbundled Network Elements are only applicable to carriers who are certified competitive Local Exchange Carriers in Kentucky and who have executed an interconnection agreement with Cincinnati Bell Telephone, Issued pursuant to Commission Order in Administrative Case No. 9821 (N)

Issued: July 3, 2003

Effective July 3, 2003  
 EXECUTIVE DIRECTOR

President, Cincinnati, Ohio

ACCESS SERVICE TARIFF  
PSC No. 2

CINCINNATI BELL TELEPHONE COMPANY

Original Page 601

19. Unbundled Network Elements (UNE's)\* (Cont'd)

(N)

19.2 Unbundled Network Element Rates (Cont'd)

19.2.4 - Unbundled Network Elements

A. Analog Loops & NIDS

|    |  | Band 1  | Band 2   | Band 3** |
|----|--|---|----------|----------|
| 1. | 2-Wire Voice Grade Analog Loop without NID       | Monthly \$ 10.59<br>NRC - Fixed 55.70<br>NRC / Unit 34.03 | \$ 13.47 | \$ 15.43 |
| 2. | 4-Wire Voice Grade Analog Loop without NID       | Monthly \$ 20.55<br>NRC - Fixed 55.70<br>NRC / Unit 68.46 | \$ 26.32 | \$ 30.24 |
| 3. | 2-Wire NID                                       | Monthly \$ 0.60   | \$ 0.60  | \$ 0.60  |
| 4. | 4-Wire NID                                       | Monthly \$ 1.20   | \$ 1.20  | \$ 1.20  |
| 5. | 2-Wire Voice Grade Analog Loop & NID Combination | Monthly \$ 11.12<br>NRC - Fixed 55.70<br>NRC / Unit 34.03 | \$ 14.01 | \$ 15.97 |
| 6. | 4-Wire Voice Grade Analog Loop & NID Combination | Monthly \$ 21.62<br>NRC - Fixed 55.70<br>NRC / Unit 68.46 | \$ 27.39 | \$ 31.31 |

B. Conditioning Options for 2-wire and 4-wire Analog Loops

|    |                           |  |  |  |
|----|---------------------------|--|--|--|
| 1. | Improved Voice Grade Loss |  |  |  |
| a. | Conditioning              | Monthly \$ 17.29<br>NRC - Fixed<br>NRC / Unit \$ 50.82 |  |  |

\* Unbundled Network Elements are only applicable to carriers who are certified Competitive Local Exchange Carriers in Kentucky and who have executed an interconnection agreement with

PUBLIC SERVICE COMMISSION  
EFFECTIVE

\*\* Central Office Rates bands are listed in Section 19 1

JUL 03 2003

Issued: July 3, 2003

President, Cincinnati, Ohio

Effective PURSUANT TO 2003 KAR 5 011  
SECTION 9 (1)

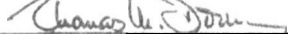
BY   
EXECUTIVE DIRECTOR

ACCESS SERVICE TARIFF  
PSC No. 2

CINCINNATI BELL TELEPHONE COMPANY

Original Page 602

19. Unbundled Network Elements (UNE's)\* (Cont'd)

(N)

19.2 Unbundled Network Element Rates (Cont'd)

19.2.4 - Unbundled Network Elements (Cont'd)

2. Non-Loaded Copper Loop Guarantee

a. Load Removal (up to 5 Loops  
to same location) NRC - Fixed \$ 445.13  
NRC / Unit 64.42

3. ISDN Compatible conditioning  
a Conditioning Copper Loop Monthly \$ 36.04  
NRC - Fixed 445.13  
NRC / Unit 68.35

b Conditioning Derived Loop Monthly \$ 31.36  
NRC - Fixed 38.39  
NRC / Unit 16.74

|    |                           |                   | Band 1    | Band 2   | Band 3** |
|----|---------------------------|-------------------|-----------|----------|----------|
| C. | Digital Loops             |                   |           |          |          |
| 1  | 4-Wire 64 Kbps Digital    | Monthly \$ 38.02  | \$ 44.37  | \$ 47.31 |          |
|    |                           | NRC - Fixed 55.70 |           |          |          |
|    |                           | NRC / Unit 68.46  |           |          |          |
| 2  | 4-Wire 1.544 Mbps Digital | Monthly \$103.31  | \$ 90.32  | \$ 83.70 |          |
|    |                           | NRC - Fixed 90.28 |           |          |          |
|    |                           | NRC / Unit 290.74 |           |          |          |
| 3  | DS-3 LOOP                 | Monthly \$ 591.50 | \$ 592.87 |          |          |
|    |                           | NRC - Fixed 92.90 |           |          |          |
|    |                           | NRC / Unit 357.17 |           |          |          |

\* Unbundled Network Elements are only applicable to carriers who are certified Competitive Local Exchange Carriers in Kentucky and who have executed an interconnection agreement with Cincinnati Bell Telephone. Issued pursuant to Commission Order in Administrative Case No. 382.

\*\* Central Office Rates bands are listed in Section 19.1.

PUBLIC SERVICE COMMISSION  
OF KENTUCKY  
EFFECTIVE

Issued: July 3, 2003

President, Cincinnati, Ohio

Effective: JULY 31 2003

PURSUANT TO 807 KAR 5.011  
SECTION 9(1)

BY Charles L. Dore  
EXECUTIVE DIRECTOR

ACCESS SERVICE TARIFF  
PSCK No. 2

CINCINNATI BELL TELEPHONE COMPANY

Original Page 603

19. Unbundled Network Elements (UNE's)\* (Cont'd)

(N)

19.2 Unbundled Network Element Rates (Cont'd)

19.2.4 - Unbundled Network Elements (Cont'd)

| D. | xDSL Compatible Loops                                    | Band 1  | Band 2   | Band 3** |
|----|--|---|----------|----------|
| 1  | 2-Wire xDSL Compatible Loop without NID                  | Monthly \$ 10.59<br>NRC - Fixed 55.70<br>NRC / Unit 34.03 | \$ 13.47 | \$ 15.43 |
|    | 2-Wire xDSL Compatible Loop & NID Combination            | Monthly \$ 11.12<br>NRC - Fixed 55.70<br>NRC / Unit 34.03 | \$ 14.01 | \$ 15.97 |
| 2  | 4-Wire xDSL Compatible Loop without NID                  | Monthly \$ 20.55<br>NRC - Fixed 55.70<br>NRC / Unit 68.46 | \$ 26.32 | \$ 30.24 |
|    | 4-Wire xDSL Compatible Loop & NID Combination            | Monthly \$ 21.62<br>NRC - Fixed 55.70<br>NRC / Unit 68.46 | \$ 27.39 | \$ 31.31 |
| 3  | Conditioning for xDSL 2-wire and 4-wire Compatible Loops |   |          |          |
| a  | Conditioning Derived Loop (When applicable)              | Monthly \$ 31.36<br>NRC - Fixed 38.39<br>NRC / Unit 16.74 |          |          |
| b  | Removal of bridged taps                                  | NRC - Fixed \$107.60<br>NRC / Unit 139.21                 |          |          |
| c  | Load Removal (up to 5 Loops to same location)            | NRC - Fixed \$445.13<br>NRC / Unit 64.42                  |          |          |
| d  | Removal of Electronics Equipment                         | NRC - Fixed \$107.60<br>NRC / Unit 139.21                 |          |          |

\* Unbundled Network Elements are only applicable to carriers who are certified Competitive Local Exchange Carriers in Kentucky and who have executed an interconnection agreement with Cincinnati Bell Telephone. Issued pursuant to Commission Order in Administrative Case No. 382.

\*\* Central Office Rates bands are listed in Section 19.1.

PURSUANT TO 807 KAR 5 011

Issued: July 3, 2003

President, Cincinnati, Ohio

Effective: July 3, 2003

BY Thomas L. Brown  
EXECUTIVE DIRECTOR

SECTION 9(1)

100-03-2003  
EFFECTIVE

(N)

ACCESS SERVICE TARIFF  
PSCK No. 2

CINCINNATI BELL TELEPHONE COMPANY

Original Page 604

19. Unbundled Network Elements (UNE's)\* (Cont'd)

(N)

19.2 Unbundled Network Element Rates (Cont'd)

19.2.4 - Unbundled Network Elements (Cont'd)

E. Unbundled Local Switching

1. Port Rates

a Line Side Ports

|           |                     |             |          |
|-----------|---------------------|-------------|----------|
| 1         | Analog Basic        | Monthly     | \$ 4.87  |
|           |                     | NRC - Fixed |          |
|           |                     | NRC / Unit  | \$ 14.77 |
|           |                     |             |          |
| 2         | Analog PBX          | Monthly     | \$ 2.56  |
|           |                     | NRC - Fixed |          |
|           |                     | NRC / Unit  | \$ 25.13 |
|           |                     |             |          |
| 3         | ISDN Basic<br>(BRI) | Monthly     | \$ 16.76 |
|           |                     | NRC - Fixed |          |
|           |                     | NRC / Unit  | \$ 25.04 |
|           |                     |             |          |
| Centrex   |                     |             |          |
| 4         | Analog Line         | Monthly     | \$ 5.54  |
|           |                     | NRC - Fixed |          |
|           |                     | NRC / Unit  | \$ 32.05 |
|           |                     |             |          |
| Analog    |                     |             |          |
| Attendant |                     |             |          |
| Line      |                     |             |          |
|           |                     | Monthly     | \$ 7.51  |
|           |                     | NRC - Fixed |          |
|           |                     | NRC / Unit  | \$ 32.05 |
|           |                     |             |          |
|           | ISDN Line           | Monthly     | \$ 26.37 |
|           |                     | NRC - Fixed |          |
|           |                     | NRC / Unit  | \$ 35.74 |
|           |                     |             |          |
| ISDN      |                     |             |          |
| Attendant |                     |             |          |
| Line      |                     |             |          |
|           |                     | Monthly     | \$ 30.28 |
|           |                     | NRC - Fixed |          |
|           |                     | NRC / Unit  | \$ 35.74 |

\* Unbundled Network Elements are only applicable to carriers who are certified Competitive Local Exchange Carriers in Kentucky and who have executed an interconnection agreement with Cincinnati Bell Telephone Company. Issued pursuant to Commission Order in Administrative Proceeding No. 382 (N)

Issued: July 3, 2003

President, Cincinnati, Ohio

Effective: July 3, 2003

PURSUANT TO 807 KAR 5:011  
SECTION 9(1)

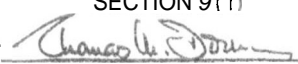
BY   
EXECUTIVE DIRECTOR



ACCESS SERVICE TARIFF  
PSCK No. 2

CINCINNATI BELL TELEPHONE COMPANY

Original Page 605

19. Unbundled Network Elements (UNE's)\* (Cont'd)

(N)

19.2 Unbundled Network Element Rates (Cont'd)

19.2.4 - Unbundled Network Elements (Cont'd)

b Trunk Side Ports

|   |                       |  |
|---|-----------------------|--|
| 1 | Analog DID            | Monthly \$ 12.14<br>NRC - Fixed<br>NRC/Unit \$ 36.10 |
| 2 | Digital Trunk         | Monthly \$145.46<br>NRC - Fixed<br>NRC/Unit \$ 63.26 |
| 3 | ISDN Primary<br>(PRI) | Monthly \$239.68<br>NRC - Fixed<br>NRC/Unit \$ 77.62 |

c Setup / Activation Features for Ports

|   |   |                           |                     |                        |
|---|---|---------------------------|---------------------|------------------------|
| 1 | Trunk Group Setup<br>Analog DID<br>Trunk Port | NRC - Fixed<br>NRC/Unit   | Initial<br>\$ 16.29 | Subsequent<br>\$ 13.14 |
|   | Digital Trunk<br>Port                         | NRC - Fixed<br>NRC/Unit   | \$ 16.29            | \$ 13.14               |
|   | ISDN Primary<br>(PRI) Port                    | NRC - Fixed<br>NRC/Unit   | Initial<br>\$ 16.29 | Subsequent<br>\$ 13.14 |
| 2 | Trunk Member Setup<br>Digital Trunk<br>Port   | NRC - Fixed<br>NRC/Unit   | \$ 5.08             | \$ 9.34                |
|   | ISDN Primary<br>(PRI) Port                    | NRC - Fixed<br>NRC / Unit | \$ 5.08             | \$ 9.34                |

\* Unbundled Network Elements are only applicable to carriers who are Public Service Commission of Kentucky Local Exchange Carriers in Kentucky and who have executed an interconnection agreement with Cincinnati Bell Telephone. Issued pursuant to Commission Order in Administrative Case No. 382

(N)

JUL 03 2003

President, Cincinnati, Ohio

ACCESS SERVICE TARIFF  
PSCK No. 2

CINCINNATI BELL TELEPHONE COMPANY

Original Page 606

19. Unbundled Network Elements (UNE's)\* (Cont'd)

(N)

19.2 Unbundled Network Element Rates (Cont'd)

19.2.4 - Unbundled Network Elements (Cont'd)

|   |   |                           |         |         |
|---|---|---------------------------|---------|---------|
| 3 | Route Index Setup<br>Analog DID<br>Trunk Port           | NRC - Fixed<br>NRC/Unit   | \$ 4.62 | \$ 4.62 |
|   | Digital<br>Trunk Port                                   | NRC - Fixed<br>NRC/Unit   | \$ 4.62 | \$ 4.62 |
|   | ISDN Primary<br>(PRI) Port                              | NRC - Fixed<br>NRC/Unit   | \$ 4.62 | \$ 4.62 |
| 4 | Directory Number Activation<br>Analog DID<br>Trunk Port | NRC - Fixed<br>NRC/Unit   | \$ 1.80 | \$ 1.80 |
|   | Digital<br>Trunk Port                                   | NRC - Fixed<br>NRC/Unit   | \$ 1.80 | \$ 1.80 |
|   | Digital<br>Trunk Port                                   | NRC - Fixed<br>NRC/Unit   | \$ 1.80 | \$ 1.80 |
| 5 | Analog Basic Port Features                              | NRC - Fixed<br>NRC / Unit | --      | -       |

\* Unbundled Network Elements are only applicable to carriers who are certified Competitive Local Exchange Carriers in Kentucky and who have executed an interconnection agreement with Cincinnati Bell Telephone. Issued pursuant to Commission Order in Administrative Case No. 382

(N)

PUBLIC SERVICE COMMISSION  
OF KENTUCKY  
EFFECTIVE

Issued: July 3, 2003

President, Cincinnati, Ohio

Effective: July 3, 2003

JUL 03 2003

PURSUANT TO 807 KAR 5:011  
SECTION 9 (1)

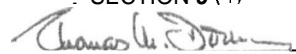
BY   
EXECUTIVE DIRECTOR

ACCESS SERVICE TARIFF  
PSCK No. 2

CINCINNATI BELL TELEPHONE COMPANY

Original Page 607

19. Unbundled Network Elements (UNE's)\* (Cont'd)

(N)

19.2 Unbundled Network Element Rates (Cont'd)

19.2.4 - Unbundled Network Elements (Cont'd)

|   |  |                           |         |         |
|---|--|---------------------------|---------|---------|
| 6 | Analog PBX Port Features<br>Hunting                        | NRC - Fixed<br>NRC / Unit | \$ 2.53 | \$ 2.53 |
|   | To11<br>Restriction  | NRC - Fixed<br>NRC/Unit   | \$ 2.53 | \$ 2.53 |
| 7 | ISDN BRI Port Features<br>Circuit Switched<br>Hunting      | NRC - Fixed<br>NRC/Unit   | \$ 1.08 | \$ 1.08 |
|   | Circuit Switched<br>Add'l. Call<br>References              | NRC - Fixed<br>NRC/Unit   | \$ 1.08 | \$ 1.08 |
|   | Circuit Switched<br>Six Party Conference<br>Calling        | NRC - Fixed<br>NRC/Unit   | \$ 1.08 | \$ 1.08 |
|   | Circuit Switched<br>Call Pickup                            | NRC - Fixed<br>NRC/Unit   | \$ 1.08 | \$ 1.08 |
|   | Circuit Switched<br>Electronic Key<br>Telephone<br>Service | NRC - Fixed<br>NRC/Unit   | # 1.08  | \$ 1.08 |

\* Unbundled Network Elements are only applicable to carriers who are certified Competitive

Local Exchange Carriers in Kentucky and who have executed an interconnection agreement with Cincinnati Bell Telephone. Issued pursuant to Commission Order in Administrative Proceedings No. 382.

connection agreement with  
PUBLIC SERVICE COMMISSION  
BY REFERENCE  
EFFECTIVE

Issued: July 3, 2003

President, Cincinnati, Ohio

Effective: July 3, 2003

PURSUANT TO 807 KAR 5:011  
SECTION 9 (1)

BY   
EXECUTIVE DIRECTOR

ACCESS SERVICE TARIFF  
PSCK No. 2

CINCINNATI BELL TELEPHONE COMPANY

Original Page 608

19. Unbundled Network Elements (UNE's)\* (Cont'd)

(N)

19.2 Unbundled Network Element Rates (Cont'd)

19.2.4 - Unbundled Network Elements (Cont'd)

|   |   |  |                         |         |         |
|---|---|--|-------------------------|---------|---------|
|   |   | Circuit Switched Add'l.<br>Directory<br>Number | NRC - Fixed<br>NRC/Unit | \$ 1.08 | \$ 1.08 |
|   |   | Custom Terminal<br>Configuration               | NRC - Fixed<br>NRC/Unit | \$ 1.08 |         |
| 8 | Centrex Analog Port Features<br>Hunting           |  | NRC - Fixed<br>NRC/Unit | \$ 2.53 | \$ 2.53 |
|   | To11<br>Restriction                               |  | NRC - Fixed<br>NRC/Unit | \$ 2.53 | \$ 2.53 |
|   | Uniform Call<br>Distribution                      |  | NRC - Fixed<br>NRC/Unit | \$ 3.97 | \$ 3.97 |
| 9 | Centrex Analog Attendant Port Features<br>Hunting |  | NRC - Fixed<br>NRC/Unit | \$ 2.53 | \$ 2.53 |
|   | Uniform Call<br>Distribution                      |  | NRC - Fixed<br>NRC/Unit | \$ 3.97 | \$ 3.97 |

\* Unbundled Network Elements are only applicable to carriers who are certified Competitive Local Exchange Carriers in Kentucky and who have executed an interconnection agreement with Cincinnati Bell Telephone. Issued pursuant to Commission Order in Administrative Case No. 382.

(N)

PUBLIC SERVICE COMMISSION  
OF KENTUCKY  
EFFECTIVE

Issued: July 3, 2003

President, Cincinnati, Ohio

Effective: July 3, 2003  
JUL 03 2003

PURSUANT TO 807 KAR 5.011  
SECTION 9(1)

BY   
EXECUTIVE DIRECTOR

ACCESS SERVICE TARIFF  
 PSCK No. 2

CINCINNATI BELL TELEPHONE COMPANY

Original Page 609

19. Unbundled Network Elements (UNE's)\* (Cont'd)

(N)

19.2 Unbundled Network Element Rates (Cont'd)

19.2.4 - Unbundled Network Elements (Cont'd)

|    |                               |                         |         |         |
|----|-------------------------------|-------------------------|---------|---------|
| 10 | Centrex ISDN Port Features    |                         |         |         |
|    | Service Line Restrictions     | NRC - Fixed<br>NRC/Unit | \$ 3.97 | \$ 3.97 |
|    | Call Restriction Levels       | NRC - Fixed<br>NRC/Unit | \$ 1.80 | \$ 1.80 |
|    | Circuit Switched Data Hunting | NRC - Fixed<br>NRC/Unit | \$ 3.97 | \$ 3.97 |
|    | Hunting                       | NRC - Fixed<br>NRC/Unit | \$ 2.53 | \$ 2.53 |
|    | Toll Restriction              | NRC - Fixed<br>NRC/Unit | \$ 2.53 | \$ 2.53 |
|    | Uniform Call Distribution     | NRC - Fixed<br>NRC/Unit | \$ 3.97 | \$ 3.97 |
|    | Custom Set Configuration      | NRC - Fixed<br>NRC/Unit | \$ 2.53 | \$ 2.53 |

\* Unbundled Network Elements are only applicable to carriers who are certified Competitive Local Exchange Carriers in Kentucky and who have executed an interconnection agreement with Cincinnati Bell Telephone. Issued pursuant to Commission Order in Administrative Case No. 382 (N)

PUBLIC SERVICE COMMISSION  
 OF KENTUCKY  
 EFFECTIVE

Issued: July 3, 2003

President, Cincinnati, Ohio

Effective: July 3, 2003

PURSUANT TO 807 KAR 5 011  
 SECTION 9(1)

BY Charles L. Dorn  
 EXECUTIVE DIRECTOR

ACCESS SERVICE TARIFF  
PSCK No. 2

CINCINNATI BELL TELEPHONE COMPANY

Original Page 610

19. Unbundled Network Elements (UNE's)\* (Cont'd)

(N)

19.2 Unbundled Network Element Rates (Cont'd)

19.2.4 - Unbundled Network Elements (Cont'd)

|    |  |                         |         |         |
|----|--|-------------------------|---------|---------|
| 11 | Centrex ISDN Attendant Port Features<br>Service Line<br>Restrictions | NRC - Fixed<br>NRC/Unit | \$ 3.97 | \$ 3.97 |
|    | Call Restriction<br>Levels   | NRC - Fixed<br>NRC/Unit | \$ 1.80 | \$ 1.80 |
|    | Circuit Switched<br>Data Hunting                                     | NRC - Fixed<br>NRC/Unit | \$ 3.97 | \$ 3.97 |
|    | Hunting  | NRC - Fixed<br>NRC/Unit | \$ 2.53 | \$ 2.53 |
|    | Toll<br>Restriction  | NRC - Fixed<br>NRC/Unit | \$ 2.53 | \$ 2.53 |
|    | Uniform Call<br>Distribution   | NRC - Fixed<br>NRC/Unit | \$ 3.97 | \$ 3.97 |
|    | Custom Set<br>Configuration  | NRC - Fixed<br>NRC/Unit | \$ 2.53 | \$ 2.53 |

\* Unbundled Network Elements are only applicable to carriers who are certified Competitive Local Exchange Carriers in Kentucky and who have executed an interconnection agreement with Cincinnati Bell Telephone. Issued pursuant to Commission Order in Administrative Case No. 382.

(N)

JUL 03 2003

Issued July 3, 2003

President, Cincinnati, Ohio

Effective Pursuant to 9802000 AR 5.011  
SECTION 9 (1)

BY  EXECUTIVE DIRECTOR

ACCESS SERVICE TARIFF  
PSCK No. 2

CINCINNATI BELL TELEPHONE COMPANY

Original Page 611

19. Unbundled Network Elements (UNE's)\* (Cont'd)

(N)

19.2 Unbundled Network Element Rates (Cont'd)

19.2.4 - Unbundled Network Elements (Cont'd)

12 Centrex Packet Switched Data Optional Features

|                                 |                         |         |         |
|---------------------------------|-------------------------|---------|---------|
| Add'l. Logical<br>Data Channels | NRC - Fixed<br>NRC/Unit | \$ 5.42 | \$ 5.42 |
|---------------------------------|-------------------------|---------|---------|

|                              |                         |         |         |
|------------------------------|-------------------------|---------|---------|
| Permanent Virtual<br>Circuit | NRC - Fixed<br>NRC/Unit | \$ 6.14 | \$ 6.14 |
|------------------------------|-------------------------|---------|---------|

|                           |                         |         |         |
|---------------------------|-------------------------|---------|---------|
| X.25 Hunt Group<br>Member | NRC - Fixed<br>NRC/Unit | \$ 7.59 | \$ 7.59 |
|---------------------------|-------------------------|---------|---------|

13 Digital (DS1) Trunk Port w/PRI Optional Features

|              |                         |          |          |
|--------------|-------------------------|----------|----------|
| Call-By-Call | NRC - Fixed<br>NRC/Unit | \$102.60 | \$102.60 |
|--------------|-------------------------|----------|----------|

|       |                         |         |         |
|-------|-------------------------|---------|---------|
| ICLID | NRC - Fixed<br>NRC/Unit | \$ 1.21 | \$ 1.21 |
|-------|-------------------------|---------|---------|

|                      |                         |          |          |
|----------------------|-------------------------|----------|----------|
| Back-Up D<br>Channel | NRC - Fixed<br>NRC/Unit | \$ 51.48 | \$ 51.48 |
|----------------------|-------------------------|----------|----------|

\* Unbundled Network Elements are only applicable to carriers who are certified Competitive Local Exchange Carriers in Kentucky and who have executed an interconnection agreement with Cincinnati Bell Telephone. Issued pursuant to Commission Order in Administrative Case No. 382.

(N)

PUBLIC SERVICE COMMISSION  
OF KENTUCKY  
EFFECTIVE

Issued: July 3, 2003

President, Cincinnati, Ohio

JUL 03 2003  
Effective: July 3, 2003  
PURSUANT TO 807 KAR 5.011  
SECTION 9 (1)

BY Charles H. Dorn  
EXECUTIVE DIRECTOR

ACCESS SERVICE TARIFF  
PSCK No. 2

CINCINNATI BELL TELEPHONE COMPANY

Original Page 612

19. Unbundled Network Elements (UNE's)\* (Cont'd)

(N)

19.1 Unbundled Network Element Rates (Cont'd)

19.2.4 - Unbundled Network Elements (Cont'd)

14 Centrex Optional System Features

|   |                         |          |          |
|---|-------------------------|----------|----------|
| Conference Calling<br>6 Way                 | NRC - Fixed<br>NRC/Unit | \$ 1.80  | \$ 1.80  |
| Queuing with Delay<br>Announcement          | NRC - Fixed<br>NRC/Unit | \$ 3.97  | # 3.97   |
| Tie Line Term - Tandem<br>Tie Trunks        | NRC - Fixed<br>NRC/Unit | \$102.60 | \$102.60 |
| Tie Line Term -<br>Non-Tandem<br>Tie Trunks | NRC - Fixed<br>NRC/Unit | \$102.60 | \$102.60 |
| WATS 800<br>Termination                     | NRC - Fixed<br>NRC/Unit | \$ 6.14  | \$ 6.14  |
| WATS Outgoing Group<br>Termination          | NRC - Fixed<br>NRC/Unit | \$ 6.14  | \$ 6.14  |
| WATS Two-Way Group<br>Termination           | NRC - Fixed<br>NRC/Unit | \$ 6.14  | \$ 6.14  |

15 Centrex Setup Charge

ICB

2 Usage Rate for Local Switching Per Msg/Per MOU 0 001931

\* Unbundled Network Elements are only applicable to carriers who are certified by the Public Service Commission as Local Exchange Carriers in Kentucky and who have executed an interconnection agreement with Cincinnati Bell Telephone Company. Issued pursuant to Commission Order in Administrative Case No. 382-03-0011.

JUL 08 2003

Issued July 3, 2003

President, Cincinnati, Ohio

Effective Pursuant to PSCK 5011-10-0001

SECTION 9(1)  
BY Charles L. Dorn  
EXECUTIVE DIRECTOR



ACCESS SERVICE TARIFF  
PSCK No. 2

CINCINNATI BELL TELEPHONE COMPANY

Original Page 613

19. Unbundled Network Elements (UNE's)\* (Cont'd)

(N)

19.2 Unbundled Network Element Rates (Cont'd)

19.2.4 - Unbundled Network Elements (Cont'd)

F. Interoffice Transmission Facilities

|   |                                   |                |          |
|---|-----------------------------------|----------------|----------|
| 1 | Shared Transport                  | Per MsgPer MOU | 0.001318 |
| 2 | Dedicated Transport               |                |          |
| a | Entrance Facilities               |                | Band 1   |
|   | Entrance Facility - DS1 (1C0-2CP) | Monthly        | \$137.33 |
|   |                                   | NRC-Fixed      | \$ 90.28 |
|   |                                   | NRC/Unit       | \$290.74 |
|   | Entrance Facility - DS1 (2C0-2CP) | Monthly        | \$157.53 |
|   |                                   | NRC-Fixed      | \$ 90.28 |
|   |                                   | NRC/Unit       | \$290.74 |
|   | Entrance Facility - DS1 (1C0-1CP) | Monthly        | \$113.46 |
|   |                                   | NRC-Fixed      | \$ 90.28 |
|   |                                   | NRC/Unit       | \$290.74 |
|   | Entrance Facility - DS3 (1C0-2CP) | Monthly        | \$577.54 |
|   |                                   | NRC-Fixed      | \$ 92.90 |
|   |                                   | NRC/Unit       | \$357.17 |
|   | Entrance Facility - DS3 (2C0-2CP) | Monthly        | \$686.16 |
|   |                                   | NRC-Fixed      | \$ 92.90 |
|   |                                   | NRC/Unit       | \$357.17 |
|   | Entrance Facility - DS3 (1C0-1CP) | Monthly        | \$372.15 |
|   |                                   | NRC-Fixed      | \$ 92.90 |
|   |                                   | NRC/Unit       | \$357.17 |
|   | Point to Point OC-3               |                |          |
|   | Entrance Facility                 | Monthly        | \$930.23 |
|   |                                   | NRC-Fixed      | \$ 30.32 |
|   |                                   | NRC/Unit       | \$511.71 |

PUBLIC SERVICE COMMISSION  
OF KENTUCKY  
Competitive

\* Unbundled Network Elements are only applicable to carriers who are certified Competitive Local Exchange Carriers in Kentucky and who have executed an interconnection agreement with

Issued July 3, 2003

President, Cincinnati, Ohio

PURSUANT TO RC K.A.R. 5011  
Effective: July 3, 2003

BY   
EXECUTIVE DIRECTOR

ACCESS SERVICE TARIFF  
PSCK No. 2

CINCINNATI BELL TELEPHONE COMPANY

Original Page 614

19. Unbundled Network Elements (UNE's)\* (Cont'd)

(N)

19.2 Unbundled Network Element Rates (Cont'd)

19.2.4 - Unbundled Network Elements (Cont'd)

|   |  |             |           |            |           |
|---|--|-------------|-----------|------------|-----------|
|   | Point to Point OC-12<br>Entrance Facility  | Monthly     | \$1407.94 |            |           |
|   |  | NRC-Fixed   | \$ 30.32  |            |           |
|   |  | NRC/Unit    | \$511.71  |            |           |
|   | Point to Point OC-48<br>Entrance Facility  | Monthly     | \$3515.73 |            |           |
|   |  | NRC-Fixed   | \$ 30.32  |            |           |
|   |  | NRC/Unit    | \$511.71  |            |           |
| b | Interoffice Transport  |             | Band 1    | Band 2     | Band 3**  |
|   | Inter-Office - (DS0) -<br>Fixed per Circuit<br>(Only for Loop<br>Transport Combination #1) | Monthly     | \$ 36.19  | \$ 36.56   | \$ 37.11  |
|   |  | NRC - Fixed | \$ 53.15  |            |           |
|   |  | NRC/Unit    | \$ 155.71 |            |           |
|   | Inter-Office - (DS0)<br>Air Mileage per Air Mile   | Monthly     | \$ 0.05   | \$ 0.05    | \$ 0.05   |
|   | Inter-Office - (DS1)<br>Fixed per Circuit  | Monthly     | \$ 59.71  | \$ 76.72   | \$ 99.76  |
|   |  | NRC - Fixed | \$ 54.33  |            |           |
|   |  | NRC/Unit    | \$ 155.71 |            |           |
|   | Inter-Office - (DS1)<br>Air Mileage per Air Mile   | Monthly     | \$ 0.52   | \$ 0.52    | \$ 0.52   |
|   | Inter-Office - (DS3)<br>Fixed per Circuit  | Monthly     | \$ 672.60 | \$ 1161.23 | \$1637.20 |
|   |  | NRC - Fixed | \$ 81.08  |            |           |
|   |  | NRC / Unit  | \$ 179.96 |            |           |

\* Unbundled Network Elements are only applicable to carriers who are certified Competitive Local Exchange Carriers in Kentucky and who have executed an interconnection agreement with the Public Service Commission of Kentucky. Order in Administrative Case No. 382.

\*\* Central Office Rates bands are listed in Section 19.1.

Issued: July 3, 2003

President, Cincinnati, Ohio

JUL 03 2003  
PUBLIC SERVICE COMMISSION  
OF KENTUCKY  
EFFECTIVE JULY 3, 2003  
SECTION 9(1)  
BY *Charles L. Brown*  
EXECUTIVE DIRECTOR



ACCESS SERVICE TARIFF  
PSCK No. 2

CINCINNATI BELL TELEPHONE COMPANY

Original Page 616

19. Unbundled Network Elements (UNE's)\* (Cont'd)

(N)

19.2 Unbundled Network Element Rates (Cont'd)

19.2.4 - Unbundled Network Elements (Cont'd)

|   |             |           |           |            |
|---|-------------|-----------|-----------|------------|
| MUX - DS1 to<br>Voice Grade/DS0             | Monthly     | \$ 246.26 |           |            |
|   | NRC - Fixed | \$ 34.29  |           |            |
|   | NRC / Unit  | \$ 81.91  |           |            |
| <br>  |             |           |           |            |
| Pt. - Pt. OC-3-<br>Add/Drop MUX Arrangement | Monthly     | \$ 978.37 |           |            |
|   | NRC - Fixed | \$ 17.04  |           |            |
|   | NRC/Unit    | \$ 161.35 |           |            |
| <br>  |             |           |           |            |
| Pt. - Pt. OC-3<br>Add/Drop Function per DS3 | Monthly     | \$ 55.28  |           |            |
|   |             |           | Initial   | Subsequent |
| (Customer Premise)                          | NRC - Fixed | \$ 33.76  | \$ 33.76  | \$ 42.90   |
|   | NRC/Unit    | \$ 171.12 | \$ 171.12 | \$ 216.01  |
| <br>  |             |           |           |            |
| Pt. - Pt. OC-3<br>Add/Drop Function per DS3 | Monthly     | \$ 65.58  |           |            |
| (Central Office)                            | NRC - Fixed | \$ 33.76  | \$ 33.76  | \$ 42.90   |
|   | NRC / Unit  | \$ 171.12 | \$ 171.12 | \$ 216.01  |
| <br>  |             |           |           |            |
| Pt. - Pt. OC-3<br>Add/Drop Function per DS1 | Monthly     | \$ 29.83  |           |            |
| (Customer Premise)                          | NRC - Fixed | \$ 33.76  | \$ 33.76  | \$ 42.90   |
|   | NRC/Unit    | \$ 171.12 | \$ 171.12 | \$ 216.01  |

\* Unbundled Network Elements are only applicable to carriers who are certified Competitive Local Exchange Carriers in Kentucky and who have executed an interconnection agreement with Cincinnati Bell Telephone. Issued pursuant to Commission Order in Administrative Case No. 382

(N)

Issued July 3, 2003

President, Cincinnati, Ohio

PUBLIC SERVICE COMMISSION  
OF KENTUCKY  
Effective July 3, 2003

JUL 03 2003

PURSUANT TO 807 KAR 5:011  
SECTION 9(1)

BY   
EXECUTIVE DIRECTOR

ACCESS SERVICE TARIFF  
PSC No. 2

CINCINNATI BELL TELEPHONE COMPANY

Original Page 617

19. Unbundled Network Elements (UNE's)\* (Cont'd)

(N)

19.2 Unbundled Network Element Rates (Cont'd)

19.2.4 - Unbundled Network Elements (Cont'd)

|   |             |           |           |  |
|---|-------------|-----------|-----------|--|
| Pt. - Pt. OC-3<br>Add/Drop Function per DS1   | Monthly     | \$ 35.36  |           |  |
| (Central Office)  | NRC - Fixed | \$ 33.76  | \$ 42.90  |  |
|   | NRC/Unit    | \$ 171.12 | \$ 216.01 |  |
| Pt. - Pt. oc-12<br>Add/Drop MUX Arrangement   | Monthly     | \$1201.41 |           |  |
|   | NRC - Fixed | \$ 17.04  |           |  |
|   | NRC/Unit    | \$ 161.35 |           |  |
| Pt. - Pt. OC-12 Add/Drop<br>MUX for DS1 Drops<br>(Per 84 DS1 Drops +<br>OC-3 A/D per DS1)<br>(Customer Premise) | Monthly     | \$ 640.51 |           |  |
|   | NRC - Fixed | \$ 17.04  |           |  |
|   | NRC/Unit    | \$ 161.35 |           |  |
| Pt. - Pt. OC-12 Add/Drop<br>MUX for DS1 Drops<br>(Per 84 DS1 Drops +<br>OC-3 A/D per DS1)<br>(Central Office)   | Monthly     | \$ 791.42 |           |  |
|   | NRC - Fixed | \$ 17.04  |           |  |
|   | NRC/Unit    | \$ 161.35 |           |  |
| Pt. - Pt. OC-12 Add/Drop<br>Function per OC-3<br>(Customer Premise)   | Monthly     | \$ 132.77 |           |  |
|   | NRC - Fixed | \$ 33.76  | \$ 42.90  |  |
|   | NRC/Unit    | \$ 171.12 | \$ 216.01 |  |
| Pt. - Pt. OC-12 Add/Drop<br>Function per OC-3<br>(Central Office)   | Monthly     | \$ 157.61 |           |  |
|   | NRC - Fixed | \$ 33.76  | \$ 42.90  |  |
|   | NRC/Unit    | \$ 171.12 | \$ 216.01 |  |

\* Unbundled Network Elements are only applicable to carriers who are certified Competitive Local Exchange Carriers in Kentucky and who have executed an interconnection agreement with  
PUBLIC SERVICE COMMISSION  
EFFECTIVE

Issued July 3, 2003

President, Cincinnati, Ohio

Effective JULY 3, 2003

PURSUANT TO 807 KAR 5.011  
SECTION 9(1)

BY   
EXECUTIVE DIRECTOR

ACCESS SERVICE TARIFF  
PSCK No. 2

CINCINNATI BELL TELEPHONE COMPANY

Original Page 618

19. Unbundled Network Elements (UNE's)\* (Cont'd)

(N)

19.2 Unbundled Network Element Rates (Cont'd)

19.2.4 - Unbundled Network Elements (Cont'd)

|  |             |           |           |  |
|--|-------------|-----------|-----------|--|
| Pt. - Pt. OC-12 Add/Drop<br>Function per DS3   | Monthly     | \$ 39.67  |           |  |
|  | NRC - Fixed | \$ 33.76  | \$ 42.90  |  |
|  | NRC/Unit    | \$ 171.12 | \$ 216.01 |  |
| <br>   |             |           |           |  |
| Pt. - Pt. OC-12 Add/Drop<br>Function per DS3   | Monthly     | \$ 47.05  |           |  |
|  | NRC - Fixed | \$ 33.76  | \$ 42.90  |  |
|  | NRC/Unit    | \$ 171.12 | \$ 216.01 |  |
| <br>   |             |           |           |  |
| Pt. - Pt. OC-48 Add/Drop<br>MUX Arrangement    | Monthly     | \$2918.08 |           |  |
|  | NRC - Fixed | \$ 17.04  |           |  |
|  | NRC/Unit    | \$ 161.35 |           |  |
| <br>   |             |           |           |  |
| Pt. - Pt. OC-48 Add/Drop<br>Function per OC-12 | Monthly     | \$ 510.28 |           |  |
| (Customer Premise)                             | NRC - Fixed | \$ 33.76  | \$ 42.90  |  |
|  | NRC/Unit    | \$ 171.12 | \$ 216.01 |  |
| <br>   |             |           |           |  |
| Pt. - Pt. OC-48 Add/Drop<br>Function per OC-12 | Monthly     | \$ 605.95 |           |  |
| (Central Office)                               | NRC - Fixed | \$ 33.76  | \$ 42.90  |  |
|  | NRC/Unit    | \$ 171.12 | \$ 216.01 |  |
| <br>   |             |           |           |  |
| Pt. - Pt. OC-48 Add/Drop<br>Function per OC-3  | Monthly     | \$ 274.36 |           |  |
| (Customer Premise)                             | NRC - Fixed | \$ 33.76  | \$ 42.90  |  |
|  | NRC/Unit    | \$ 171.12 | \$ 216.01 |  |

\* Unbundled Network Elements are only applicable to carriers who are certified Competitive Local Exchange Carriers in Kentucky and who have executed an interconnection agreement with Cincinnati Bell Telephone. Issued pursuant to Commission Order in Administrative Case No. 382.

(N)

Issued: July 3, 2003

President, Cincinnati, Ohio

Effective: July 3, 2003

PURSUANT TO 807 KAR 5:011  
SECTION 9 (1)

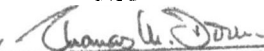
BY   
EXECUTIVE DIRECTOR

ACCESS SERVICE TARIFF  
PSC No. 2

CINCINNATI BELL TELEPHONE COMPANY

Original Page 619

19. Unbundled Network Elements (UNE's)\* (Cont'd)

(N)

19.2 Unbundled Network Element Rates (Cont'd)

19.2.4 - Unbundled Network Elements (Cont'd)

|   |             |           |           |
|---|-------------|-----------|-----------|
| Pt. - Pt. OC-48 Add/Drop<br>Function per OC-3 | Monthly     | \$ 325.76 |           |
| (Central Office)                              | NRC - Fixed | \$ 33.76  | \$ 42.90  |
|   | NRC/Unit    | \$ 171.12 | \$ 216.01 |
| Pt. - Pt. OC-48Add/Drop<br>Function per DS3   | Monthly     | \$ 35.97  |           |
| (Customer Premise)                            | NRC - Fixed | \$ 33.76  | \$ 42.90  |
|   | NRC/Unit    | \$ 171.12 | \$ 216.01 |
| Pt. - Pt. OC-48Add/Drop<br>Function per DS3   | Monthly     | \$ 42.66  |           |
| (Central Office)                              | NRC - Fixed | \$ 33.76  | \$ 42.90  |
|   | NRC/Unit    | \$ 171.12 | \$ 216.01 |
| Inter-Office - OC-3<br>Regenerator per Node   | Monthly     | \$ 735.55 |           |
|   | NRC - Fixed | \$ 23.52  |           |
|   | NRC/Unit    | \$ 269.32 |           |
| Inter-Office - OC-12<br>Regenerator per Node  | Monthly     | \$1075.59 |           |
|   | NRC - Fixed | \$ 23.52  |           |
|   | NRC/Unit    | \$ 269.32 |           |
| Inter-Office - OC-48<br>Regenerator per Node  | Monthly     | \$2547.79 |           |
|   | NRC - Fixed | \$ 23.52  |           |
|   | NRC / Unit  | \$ 269.32 |           |

\* Unbundled Network Elements are only applicable to carriers who are certified Competitive Local Exchange Carriers in Kentucky and who have executed an interconnection agreement with Cincinnati Bell Telephone Company. Issued pursuant to Commission Order in Administrative Case No. 03-00382. (N)

Issued: July 3, 2003

President, Cincinnati, Ohio

Effective: July 3, 2003

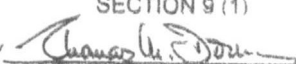
PURSUANT TO 807 KAR 5:011  
SECTION 9 (1)  
BY   
EXECUTIVE DIRECTOR

ACCESS SERVICE TARIFF  
 PSCK No. 2

CINCINNATI BELL TELEPHONE COMPANY

Original Page 620

19. Unbundled Network Elements (UNE's)\* (Cont'd)

(N)

19.2 Unbundled Network Element Rates (Cont'd)

19.2.4 - Unbundled Network Elements (Cont'd)

3 Loop / Transport Combinations

- a Loop / Transport Combination #1  
 (VG Interface at Transport Side) No Rate
- b Loop / Transport Combination #2  
 (DS1 Interface at Transport Side) No Rate

G. Miscellaneous Charges

- 1 Service Order Charge NRC \$ 12.05
- 2 Service Order Change
- Charge/Record Charge NRC \$ 12.05
- 3 Line Connection (Cross-Connect) NRC - Fixed  
 NRC/Unit \$ 8.88

H. Signaling Networks (CCS/SS7)

- 1 Signaling Link
  - a Channel Termination  
 Entrance Facility -  
 DS1 (1CO-2CP) Monthly \$ 137.33  
 NRC - Fixed \$ 90.28  
 NRC / Unit \$ 290.74
  - Entrance Facility  
 DS1 (2CO-2CP) Monthly \$ 157.53  
 NRC - Fixed \$ 90.28  
 NRC / Unit \$ 290.74

\* Unbundled Network Elements are only applicable to carriers who are certified Competitive Local Exchange Carriers in Kentucky and who have executed an interconnection agreement with Cincinnati Bell Telephone. Issued pursuant to Commission Order in Administrative Case No. 382. EFFECTIVE

(N)

Issued: July 3, 2003

President, Cincinnati, Ohio

Effective: July 3, 2003  
 JUL 03 2003

PURSUANT TO 807 KAR 5.011  
 SECTION 9(1)

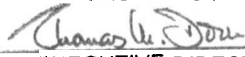
BY   
 EXECUTIVE DIRECTOR



ACCESS SERVICE TARIFF  
PSCK No. 2

CINCINNATI BELL TELEPHONE COMPANY

Original Page 621

19. Unbundled Network Elements (UNE's)\* (Cont'd)

(N)

19.2 Unbundled Network Element Rates (Cont'd)

19.2.4 - Unbundled Network Elements (Cont'd)

|   |                                    |             |           |          |          |
|---|------------------------------------|-------------|-----------|----------|----------|
|   | Entrance Facility<br>DS1 (1CO-1CP) | Monthly     | \$ 113.46 |          |          |
|   |                                    | NRC - Fixed | \$ 90.28  |          |          |
|   |                                    | NRC / Unit  | \$ 290.74 |          |          |
|   | Per 56 kbps Link                   | Monthly     | \$ 38.02  |          |          |
|   |                                    | NRC - Fixed | \$ 53.15  |          |          |
|   |                                    | NRC/Unit    | \$ 155.71 |          |          |
| b | Channel Mileage                    |             |           |          |          |
| 1 | Fixed per Circuit                  |             |           | Band 1   | Band 2   |
|   | DS1 Link                           | Monthly     | \$ 59.71  | \$ 76.72 | Band 3** |
|   |                                    | NRC - Fixed | \$ 54.33  |          | \$ 99.76 |
|   |                                    | NRC/Unit    | \$ 155.71 |          |          |
|   | 56 kbps Link                       | Monthly     | \$ 36.19  | \$ 36.56 | \$ 37.11 |
|   |                                    | NRC - Fixed | \$ 53.15  |          |          |
|   |                                    | NRC/Unit    | \$ 155.71 |          |          |
| 2 | Per Mile                           |             |           |          |          |
|   | DS1 Link                           | Monthly     | \$ 0.52   | \$ 0.52  | \$ 0.52  |
|   | 56 kbps Link                       | Monthly     | \$ 0.05   | \$ 0.05  | \$ 0.05  |
| 2 | Port Termination                   | Monthly     | \$ 459.30 |          |          |
|   |                                    | NRC - Fixed | \$1013.40 |          |          |
|   |                                    | NRC/Unit    |           |          |          |

\* Unbundled Network Elements are only applicable to carriers who are certified Competitive Local Exchange Carriers in Kentucky and who have executed an interconnection agreement with Cincinnati Bell Telephone. Issued pursuant to Commission Order in Administrative Case No. 382

\*\* Central Office Rates bands are listed in Section 19.1.

PUBLIC SERVICE COMMISSION  
OF KENTUCKY  
EFFECTIVE

JUL 03 2003

Issued: July 3, 2003

President, Cincinnati, Ohio

Effective: July 3, 2003

PURSUANT TO 807 KAR 5:011  
SECTION 9 (1)

BY Charles L. Brown  
EXECUTIVE DIRECTOR

(N)

ACCESS SERVICE TARIFF  
PSC No. 2

CINCINNATI BELL TELEPHONE COMPANY

Original Page 622

19. Unbundled Network Elements (UNE's)\* (Cont'd)

(N)

19.2 Unbundled Network Element Rates (Cont'd)

19.2.4 - Unbundled Network Elements (Cont'd)

I. Directory Services

1 Directory Assistance

a Copy of the DA Database

1 Initial Load/Refresh Per Listing \$ 0.04

2 Update Per Listing \$ 0.06

2 Directory Listing - Cincinnati Bell Area Alphabetical Directory

a Non-resale primary listings  
for customers served by  
CLEC facilities or CBT  
unbundled elements  
Per Primary Listing

Monthly \$ 0.81

NRC - Fixed \$ 18.08

NRC / Unit \$ 3.28

3 Intercept Service

Per Port with Intercept

Monthly \$ 0.37

19.1.5 - E911 Service

A Rate per End User Line

Monthly \$ 0.12

B E911 Database Access

NRC - Fixed \$ 514.91

C Optional Manual Update / Error  
Correction

Per Hour \$ 39.76

\* Unbundled Network Elements are only applicable to carriers who are certified as Local Exchange Carriers in Kentucky and who have executed an interconnection agreement with Cincinnati Bell Telephone Issued pursuant to Commission Order in Administrative Case No. 382

PUBLIC SERVICE COMMISSION

OF KENTUCKY

EFFECTIVE

JUL 03 2003

Issued: July 3, 2003

President, Cincinnati, Ohio

Effective: July 3, 2003  
PURSUANT TO 807 KAR 5:011  
SECTION 9(1)

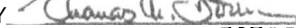
BY   
EXECUTIVE DIRECTOR

(N)

ACCESS SERVICE TARIFF  
PSC No. 2

CINCINNATI BELL TELEPHONE COMPANY

Original Page 623

19. Unbundled Network Elements (UNE's)\* (Cont'd)

(N)

19.2 Unbundled Network Element Rates (Cont'd)

19.2.6 - Collocation

|    |  |                   |           |
|----|--|-------------------|-----------|
| A. | Application Fee  | NRC - Fixed       | \$1481.66 |
| B. | Conduit  |                   |           |
|    | West Seventh Street  | Per Innerduct Ft. | \$ 0.2553 |
|    | All other wire centers   | Per Innerduct Ft. | \$ 0.081  |
| C. | Riser Space  |                   |           |
|    | West Seventh Street  | Per Foot          | \$ 0.0203 |
|    | All other wire centers   | Per Foot          | \$ 0.2588 |
| D. | Floor Space  | Per Sq. Foot      | \$ 4.34   |
| E. | Power Consumption  | Per Fused Amp     | \$ 5.75   |
| F. | Power Lead Delivery to Collocation Space   | Per Lead          |           |
|    |  | One Time          | \$ 490.60 |
|    |  | Monthly           | \$ 4.09   |
| G. | Security Access Charge   |                   |           |
|    | Entrance Door & Cage   | Per Key           | \$ 7.37   |
| H. | Internal Rated 24 Fiber Lightguide Cable<br>from vault Splice to Collocation Space |                   | \$ 1.04   |
| I. | Innerduct @ 1". within Cable Vault   |                   | \$ 0.2988 |

\* Unbundled Network Elements are only applicable to carriers who are certified Competitive Local Exchange Carriers in Kentucky and who have executed an interconnection agreement with Cincinnati Bell Telephone. Issued pursuant to Commission Order in Administrative Case No. 382.

(N)

Issued: July 3, 2003

President, Cincinnati, Ohio

Effective: July 3, 2003  
PUBLIC SERVICE COMMISSION  
OF KENTUCKY  
EFFECTIVE

JUL 03 2003

PURSUANT TO 807 KAR 5:011  
SECTION 9 (1)

BY Charles L. Dorn  
EXECUTIVE DIRECTOR

19. Unbundled Network Elements (UNE's)\* (Cont'd)

(N)

19.2 Unbundled Network Element Rates (Cont'd)

19.2.5 - Collocation (Cont)

J. Splicing Outside Fiber to Internal Rated Fiber

|   |               |           |
|---|---------------|-----------|
| 1 | 1st Splice    | \$ 153.68 |
| 2 | Add'l. Splice | \$ 17.35  |

K. Cable Pull from Entrance Facility to Collocation Space

|   |   |           |
|---|---|-----------|
| 1 | Cable Pulling from Manhole to Cable Vault           | \$ 920.49 |
| 2 | Cable Pulling from Cable Vault to Collocation Space | \$ 307.04 |

L. Cage Construction and Materials

|          |           |
|----------|-----------|
| Per Cage |           |
| One Time | \$ 972.11 |
| Monthly  | \$ 5.13   |

M. Core Drill Floor in Cage for Diverse Route

|             |           |
|-------------|-----------|
| per 4" Core | \$ 318.97 |
|-------------|-----------|

N. Space Reservation Charge

|          |          |
|----------|----------|
| Per Unit | \$ 54.18 |
|----------|----------|

O. Collocation Area Preparation Charge (COBO)

|                                 |              |           |
|---------------------------------|--------------|-----------|
| Average for all Central Offices | Per Sq. Foot | \$ 186.04 |
|---------------------------------|--------------|-----------|

\* Unbundled Network Elements are only applicable to carriers who are certified Competitive Local Exchange Carriers in Kentucky and who have executed an interconnection agreement with Cincinnati Bell Telephone. Issued pursuant to Commission Order in Administrative Case No. 382.

(N)

Issued: July 3, 2003

President, Cincinnati, Ohio

PUBLIC SERVICE COMMISSION  
OF KENTUCKY  
EFFECTIVE  
Effective: July 3, 2003

JUL 03 2003

PURSUANT TO 807 KAR 5:011  
SECTION 9 (1)

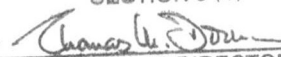
BY   
EXECUTIVE DIRECTOR



ACCESS SERVICE TARIFF  
PSCK No. 2

CINCINNATI BELL TELEPHONE COMPANY

Original Page 626

19. Unbundled Network Elements (UNE's)\* (Cont'd)

(N)

19.2 Unbundled Network Element Rates (Cont'd)

19.2.5 - Collocation (Cont)

|   |       |                                      |          |
|---|-------|--------------------------------------|----------|
| c | DS3   | Monthly<br>NRC - Fixed<br>NRC / Unit | \$ 50.47 |
| d | OC-3  | Monthly<br>NRC - Fixed<br>NRC / Unit | \$ 43.78 |
| e | OC-12 | Monthly<br>NRC - Fixed<br>NRC / Unit | \$ 43.78 |
| f | OC-48 | Monthly<br>NRC - Fixed<br>NRC / Unit | \$ 43.78 |

NOTES :

- 1 NRC denotes Nonrecurring
- 2 NRC - Fixed denotes nonrecurring charges that are billed per order.
- 3 NRC / Unit denotes nonrecurring charges that are billed per unit ordered.
- 4 For monthly rates that depend on the-geographic bands, the nonrecurring rates are listed only under the Band 1 column. However, the same nonrecurring rates apply to all bands.
- 5 Service Order Charge applies to all orders for service.

\* Unbundled Network Elements are only applicable to carriers who are certified Competitive Local Exchange Carriers in Kentucky and who have executed an interconnection agreement with Cincinnati Bell Telephone. Issued pursuant to Commission Order in Administrative Case No. 382.

(N)

Issued. July 3, 2003

President, Cincinnati, Ohio

Effective: JULY 3, 2003  
PUBLIC SERVICE COMMISSION  
OF KENTUCKY  
EFFECTIVE

JUL 03 2003

PURSUANT TO 807 KAR 5:011  
SECTION 9 (1)

BY Thomas H. Jones  
EXECUTIVE DIRECTOR