

RECEIVED

APR 13 2020

PUBLIC SERVICE
COMMISSION

**COMMONWEALTH OF KENTUCKY
BEFORE THE PUBLIC SERVICE COMMISSION**

In the matter of:

THE APPLICATION OF EAST KENTUCKY NETWORK,)
LLC FOR THE ISSUANCE OF A CERTIFICATE OF)
PUBLIC CONVENIENCE AND NECESSITY TO) CASE NO. 2020-00101
CONSTRUCT A TOWER IN MORGAN COUNTY,)
KENTUCKY.)

East Kentucky Network, LLC d/b/a Appalachian Wireless was granted authorization to provide cellular service in the KY-9 Cellular Market Area (CMA451) by the Federal Communications Commission (FCC). FCC license is included as Exhibit 1. East Kentucky Network, LLC merger documents were filed with the Commission on February 2, 2001 in Case No. 2001-022. East Kentucky Network, LLC is a Kentucky Limited Liability Company that was organized on June 16, 1998. East Kentucky Network, LLC is in good standing with the state of Kentucky.

In an effort to improve service in Morgan County, pursuant to KRS 278.020 Subsection 1 and 807 KAR 5:001, East Kentucky Network, LLC is seeking the Commission’s approval to construct a 300-foot telecommunications tower on a tract of land located at 7604 Highway 519, West Liberty, Morgan County, Kentucky (38°01’18.6994”N 83°21’48.5483”W). A map and detailed directions to the site can be found in Exhibit 7.

Construction of the proposed tower is required by public convenience and necessity. Due to increasing demand for telecommunications service, the proposed tower is necessary to provide adequate coverage. The proposed tower will improve service in Morgan County by providing an interconnection between East Kentucky Network, LLC other sites thereby forming a cohesive network.

Exhibit 2 is a list of all property owners according to the Property Valuation Administrator's record who own property within 500 feet of the proposed tower and all property owners that own property contiguous to the property upon which construction is proposed in accordance with the Property Valuation Administrator's record.

Pursuant to 807 KAR 5:063 Section 1(1)(l), Section 1(1)(m) and Section 2, all affected property owners according to the Property Valuation Administrator's record who own property within 500 feet of the proposed Tower or contiguous to the property upon which construction is proposed were notified by certified mail return receipt requested of East Kentucky Network, LLC's proposed construction and informed of their right to intervene. They were given the docket number under which this application is filed. Enclosed in Exhibit 2 is a copy of that notification.

Morgan County has no formal local planning unit. In absence of this unit, the Morgan County Judge Executive's office was notified by certified mail, return receipt requested, of East Kentucky Network, LLC's proposal and informed of their right to intervene. The Morgan County Judge Executive's office was also given the docket number under which this application is filed. Enclosed in Exhibit 3 is a copy of that notification.

Notice of the location of the proposed construction was published in the The Licking Valley Courier, April 23, 2020, edition. Enclosed is a copy of that notice in Exhibit 3. The Licking Valley Courier is the newspaper with the largest circulation in Morgan County.

A geologist was employed to determine soil and rock types and to ascertain the distance to solid bedrock. The geotechnical report is enclosed as Exhibit 4.

A copy of the tower design information is enclosed as Exhibit 5. The proposed tower has been designed by engineers at World Tower Company, Inc. and will be constructed under their supervision. Their qualifications are evidenced in Exhibit 5 by the seal and signature of the registered professional engineer responsible for this project.

The tower will be erected by S & S Tower Services of St. Albans, West Virginia. S & S Tower Services has vast experience in the erection of communications towers. Their qualifications are described in Exhibit 13.

FAA and Kentucky Airport Zoning Commission approvals are included as Exhibit 6.

No Federal Communications Commission approval is required prior to construction of this facility. Once service is established from this tower we must immediately notify the Federal Communications Commission of its operation. Prior approval is needed only if the proposed facility increases the size of the cellular geographic service area. This cell site will not expand the cellular geographic service area.

East Kentucky Network, LLC will finance the subject construction with earned surplus in its General Fund.

Estimated Cost of Construction	\$ 350,000.00
Annual Operation Expense of Tower	\$ 12,500.00

Two notice signs meeting the requirements prescribed by 807 KAR 5:063, Section 1(2), measuring at least two (2) feet in height and four (4) feet in width and containing all required language in letters of required height, have been posted, one at a visible location on the proposed site and one on the nearest public road. The two signs were posted on April 6, 2020, and will remain posted for at least two weeks after filing of this application as specified.

Enclosed in Exhibit 8 are copies of East Kentucky Network LLC's Deed for the site location along with a lot description.

The proposed construction site is on a rugged mountaintop some feet from the nearest structure. Prior to construction, the site was wooded.

East Kentucky Network, LLC's operation will not affect the use of nearby land nor its value. No more suitable site exists in the area. A copy of the search area map is enclosed in Exhibit 7.

No other tower capable of supporting East Kentucky Network, LLC's load exists in the general area; therefore, there is no opportunity for co-location of our facilities with anyone else.

Enclosed and filed as Exhibit 9 is a survey of the proposed tower site signed by a Kentucky registered professional engineer.

Exhibit 10 is a map in one (1) inch equals 200 feet scale identifying every structure and every owner of real estate within 500 feet of the proposed tower and all property owners who own contiguous property to the property upon which construction is proposed.

Exhibit 11 contains a vertical sketch of the tower supplied by James W. Caudill, Kentucky registered professional engineer.

Enclosed as Exhibit 12 is a list of utilities, corporations, or persons with whom the tower is likely to compete.

[THE REMAINDER OF THIS PAGE INTENTIONALLY LEFT BLANK.]

WHEREFORE, Applicant, having met the requirements of KRS 278.020(1), 278.650, 278.665 and all applicable rules and regulations of the PSC, respectfully requests that the PSC accept the foregoing Application for filing and grant a Certificate of Public Convenience and Necessity to construct and operate the proposed tower.

The foregoing document was prepared by Krystal Branham, Regulatory Compliance Attorney at East Kentucky Network, LLC d/b/a Appalachian Wireless. All related questions or correspondence concerning this filing should be mailed to East Kentucky Network, LLC d/b/a Appalachian Wireless, 101 Technology Trail, Ivel, KY 41642.

SUBMITTED BY: Lynn Haney By: Raura Hutto DATE: 4/10/2020
Lynn Haney, Regulatory Compliance Director

APPROVED BY: W.A. Gillum DATE: 4/3/2020
W.A. Gillum, General Manager

ATTORNEY: Krystal Branham DATE: 4/6/2020
Hon. Krystal Branham, Attorney

CONTACT INFORMATION:

W.A. Gillum, General Manager
Phone: (606) 477-2355, Ext. 111
Email: wagillum@ekn.com

Lynn Haney, Regulatory Compliance Director
Phone: (606) 477-2355, Ext. 1007
Email: lhaney@ekn.com

Krystal Branham, Attorney
Phone: (606) 477-2355, Ext. 1009
Email: kbranham@ekn.com

Mailing Address:

**East Kentucky Network, LLC
d/b/a Appalachian Wireless
101 Technology Trail
Ivel, KY 41642**

1	FCC License
2	Copies of Cell Site Notice to Land Owners
3	Notifications of County Judge Executive and Newspaper
4	Universal Soil Bearing Analysis
5	Tower Design
6	FAA and KAZC Determination
7	Driving Directions from County Court House and Map to Suitable Scale
8	Memorandum of Lease for Proposed Site with Legal Description
9	Survey of Site Signed/Sealed by Professional Engineer Registered in State of Kentucky
10	Site Survey Map with Property Owners Identified in Accordance with PVA of County
11	Vertical Profile Sketch of Proposed Tower
12	List of Competitors
13	Qualifications
14	
15	

1

ULS License

Cellular License - KNKN880 - East Kentucky Network, LLC d/b/a Appalachian Wireless

Call Sign	KNKN880	Radio Service	CL - Cellular
Status	Active	Auth Type	Regular

Market

Market	CMA451 - Kentucky 9 - Elliott	Channel Block	B
Submarket	0	Phase	2

Dates

Grant	08/30/2011	Expiration	10/01/2021
Effective	09/04/2014	Cancellation	

Five Year Buildout Date

10/23/1996

Control Points

1 U.S. 23, HAROLD, KY

Licensee

FRN	0001786607	Type	Limited Liability Company
-----	------------	------	---------------------------

Licensee

East Kentucky Network, LLC d/b/a Appalachian Wireless
 101 Technology Trail
 Ivel, KY 41642
 ATTN W.A. Gillum, General Manager / CEO
 P:(606)477-2355

Contact

Lukas, Nace, Gutierrez & Sachs, LLP	P:(703)584-8665
Pamela L Gist Esq	F:(703)584-8696
8300 Greensboro Drive	E:pgist@fcclaw.com
McLean, VA 22102	

Ownership and Qualifications

Radio Service Type	Mobile
Regulatory Status	Common Carrier Interconnected Yes

Alien Ownership

The Applicant answered "No" to each of the Alien Ownership questions.

Basic Qualifications

The Applicant answered "No" to each of the Basic Qualification questions.

Demographics

Race

Ethnicity

Gender

2

EXHIBIT 2 - LIST OF PROPERTY OWNERS

Statement Pursuant to Section 1 (1) (I) 807 KAR 5:063

Section 1 (1)(I) 1. The following is a list of every property owner who according to property valuation administrator's records, owns property within 500 feet of the proposed tower and each have been: notified by certified mail, return receipt requested, of the proposed construction,

Section 1 (1)(I) 2. Every person listed below who, according to the property valuation administrator's records, owns property within 500 feet of the proposed tower has been: Given the Commission docket number under which the application will be processed: and

Section 1 (1)(I) 3. Every person listed below who, according to property valuation administrator's records owns property within 500 feet of the proposed tower has been: Informed of his right to request intervention.

Section 2. If the construction is proposed for an area outside the incorporated boundaries of a city, the application shall state that public notices required by Section 1(1)(L) have been sent to every person who, according to the property valuation administrator, owns property contiguous to the property upon which the construction is proposed

LIST OF PROPERTY OWNERS

Clayton and Teretha Brook Johnson
444 Bluestone Road
Morehead, KY 40351

Mark Phipps
330 Elm Log Rd
West Liberty, KY 41472

Denny Beasley
425 Elm Log Rd
West Liberty, KY 41472

Jeffrey and Teena Spencer
234 Hickory Grove Road
West Liberty, KY 41472

VIA: U.S. CERTIFIED MAIL

PUBLIC NOTICE

April 10, 2020

Clayton and Teretha Brook Johnson
444 Bluestone Road
Morehead, KY 40351

RE: Public Notice-Public Service Commission of Kentucky (Case No. 2020-00101)

East Kentucky Network, LLC d/b/a Appalachian Wireless has applied to the Public Service Commission of Kentucky for a Certificate of Public Convenience and Necessity to construct and operate a new facility to provide cellular telecommunications service in Morgan County. The facility will include a 300'-foot self-supporting tower with attached antennas extending upwards, and an equipment shelter located on a tract of land near 7604 Highway 519, West Liberty, Morgan County, Kentucky . A map showing the location of the proposed new facility is enclosed. This notice is being sent to you because you may own property within a 500' radius of the proposed tower or own property contiguous to the property upon which construction is proposed.

The Commission invites your comments regarding the proposed construction. You also have the right to intervene in this matter. The Commission must receive your initial communication within 20 days of the date of this letter as shown above.

Your comments and request for intervention should be addressed to: Executive Director's Office, Public Service Commission of Kentucky, P.O. Box 615, Frankfort, KY 40602. Please refer to Case No. 2020-00101 in your correspondence.

If you have any questions for East Kentucky Network, LLC, please direct them to my attention at the following address: East Kentucky Network, LLC, 101 Technology Trail, Ivel, KY 41642 or call me at 606-477-2355, Ext. 1007.

Sincerely,



Lynn Haney, CPA
Regulatory Compliance Director
Enclosure 1

VIA: U.S. CERTIFIED MAIL

PUBLIC NOTICE

April 10, 2020

Mark Phipps
330 Elm Log Rd
West Liberty, KY 41472

RE: Public Notice-Public Service Commission of Kentucky (Case No. 2020-00101)

East Kentucky Network, LLC d/b/a Appalachian Wireless has applied to the Public Service Commission of Kentucky for a Certificate of Public Convenience and Necessity to construct and operate a new facility to provide cellular telecommunications service in Morgan County. The facility will include a 300'-foot self-supporting tower with attached antennas extending upwards, and an equipment shelter located on a tract of land near 7604 Highway 519, West Liberty, Morgan County, Kentucky . A map showing the location of the proposed new facility is enclosed. This notice is being sent to you because you may own property within a 500' radius of the proposed tower or own property contiguous to the property upon which construction is proposed.

The Commission invites your comments regarding the proposed construction. You also have the right to intervene in this matter. The Commission must receive your initial communication within 20 days of the date of this letter as shown above.

Your comments and request for intervention should be addressed to: Executive Director's Office, Public Service Commission of Kentucky, P.O. Box 615, Frankfort, KY 40602. Please refer to Case No. 2020-00101 in your correspondence.

If you have any questions for East Kentucky Network, LLC, please direct them to my attention at the following address: East Kentucky Network, LLC, 101 Technology Trail, Ivel, KY 41642 or call me at 606-477-2355, Ext. 1007.

Sincerely,



Lynn Haney, CPA
Regulatory Compliance Director
Enclosure 1

VIA: U.S. CERTIFIED MAIL

PUBLIC NOTICE

April 10, 2020

Denny Beasley
425 Elm Log Rd
West Liberty, KY 41472

RE: Public Notice-Public Service Commission of Kentucky (Case No. 2020-00101)

East Kentucky Network, LLC d/b/a Appalachian Wireless has applied to the Public Service Commission of Kentucky for a Certificate of Public Convenience and Necessity to construct and operate a new facility to provide cellular telecommunications service in Morgan County. The facility will include a 300'-foot self-supporting tower with attached antennas extending upwards, and an equipment shelter located on a tract of land near 7604 Highway 519, West Liberty, Morgan County, Kentucky . A map showing the location of the proposed new facility is enclosed. This notice is being sent to you because you may own property within a 500' radius of the proposed tower or own property contiguous to the property upon which construction is proposed.

The Commission invites your comments regarding the proposed construction. You also have the right to intervene in this matter. The Commission must receive your initial communication within 20 days of the date of this letter as shown above.

Your comments and request for intervention should be addressed to: Executive Director's Office, Public Service Commission of Kentucky, P.O. Box 615, Frankfort, KY 40602. Please refer to Case No. 2020-00101 in your correspondence.

If you have any questions for East Kentucky Network, LLC, please direct them to my attention at the following address: East Kentucky Network, LLC, 101 Technology Trail, Ivel, KY 41642 or call me at 606-477-2355, Ext. 1007.

Sincerely,



Lynn Haney, CPA
Regulatory Compliance Director
Enclosure 1

VIA: U.S. CERTIFIED MAIL

PUBLIC NOTICE

April 10, 2020

Jeffrey and Teena Spencer
234 Hickory Grove Road
West Liberty, KY 41472

RE: Public Notice-Public Service Commission of Kentucky (Case No. 2020-00101)

East Kentucky Network, LLC d/b/a Appalachian Wireless has applied to the Public Service Commission of Kentucky for a Certificate of Public Convenience and Necessity to construct and operate a new facility to provide cellular telecommunications service in Morgan County. The facility will include a 300'-foot self-supporting tower with attached antennas extending upwards, and an equipment shelter located on a tract of land near 7604 Highway 519, West Liberty, Morgan County, Kentucky. A map showing the location of the proposed new facility is enclosed. This notice is being sent to you because you may own property within a 500' radius of the proposed tower or own property contiguous to the property upon which construction is proposed.

The Commission invites your comments regarding the proposed construction. You also have the right to intervene in this matter. The Commission must receive your initial communication within 20 days of the date of this letter as shown above.

Your comments and request for intervention should be addressed to: Executive Director's Office, Public Service Commission of Kentucky, P.O. Box 615, Frankfort, KY 40602. Please refer to Case No. 2020-00101 in your correspondence.

If you have any questions for East Kentucky Network, LLC, please direct them to my attention at the following address: East Kentucky Network, LLC, 101 Technology Trail, Ivel, KY 41642 or call me at 606-477-2355, Ext. 1007.

Sincerely,



Lynn Haney, CPA
Regulatory Compliance Director
Enclosure 1

Hickory Grove

Location:

7604 Highway 519
West Liberty, KY 41472

Coordinates:

38°01'18.6994"N
83°21'48.5483"W

Google Earth

© 2020 Google



519

3036

2000 ft

3

VIA: U.S. CERTIFIED MAIL

April 10, 2020

John Will Stacy, Judge Executive
450 Prestonsburg Street
West Liberty, KY 41472

RE: Public Notice-Public Service Commission of Kentucky (Case No. 2020-00101)

East Kentucky Network, LLC d/b/a Appalachian Wireless has applied to the Public Service Commission of Kentucky for a Certificate of Public Convenience and Necessity to construct and operate a new facility to provide cellular telecommunications service in Morgan County. The facility will include a 300-foot self-supporting tower with attached antennas extending upwards, and an equipment shelter located on a tract of land at 7604 Highway 519, West Liberty, Morgan County, Kentucky. A map showing the location of the proposed new facility is enclosed. This notice is being sent to you because you are the County Judge Executive of Morgan County.

The Commission invites your comments regarding the proposed construction. You also have the right to intervene in this matter. The Commission must receive your initial communication within 20 days of the date of this letter as shown above.

Your comments and request for intervention should be addressed to: Executive Director's Office, Public Service Commission of Kentucky, P.O. Box 615, Frankfort, KY 40602. Please refer to Case No. 2020-00101 in your correspondence.

If you have any questions for East Kentucky Network, LLC, please direct them to my attention at the following address: East Kentucky Network, LLC, 101 Technology Trail, Ivel, KY 41642 or call me at 606-477-2355, Ext. 1007.

Sincerely,



Lynn Haney
Regulatory Compliance Director
Enclosure

dba Appalachian Wireless
101 Technology Trail
Ivel, KY 41642
Phone: 606-477-2355
Fax: 606-791-2225

EAST KENTUCKY
NETWORK



To: The Licking Valley Courier
Attn: Classifieds

From: Raina Helton
Regulatory Compliance Assistant

Email: courier@mrtc.com

Date: April 2, 2020

Re: PUBLIC NOTICE ADVERTISEMENT

Pages: 1

Please place the following Public Notice Advertisement in The Licking Valley Courier to be ran on April 23, 2020.

PUBLIC NOTICE:

RE: Public Service Commission of Kentucky (CASE NO. 2020-00101)

Public Notice is hereby given that East Kentucky Network, LLC, dba Appalachian Wireless has applied to the Kentucky Public Service Commission to construct a cellular telecommunications tower on a tract of land located at 7604 Highway 519, West Liberty, Morgan County, Kentucky. The proposed tower will be a 300 foot self-supporting tower with attached antennas. If you would like to respond to this notice, please contact the Executive Director, Public Service Commission, 211 Sower Boulevard, PO Box 615, Frankfort, Kentucky 40602. Please refer to Case No. 2020-00101.

If you have any questions about the placement of the above mentioned notice, please call me at 606-477-2375, ext. 1005.

Thank you,

Raina Helton
Regulatory Compliance Assistant

The message above and the information contained in the documents transmitted are confidential and intended only for the person(s) named above. Dissemination, distribution or copying of this communication by anyone other than the person(s) named above is prohibited. If you have received this communication in error, please notify us immediately by telephone and return the original message to us at the address listed above via regular mail. Thank you.

Hickory Grove

Location:

7604 Highway 519
West Liberty, KY 41472

Coordinates:

38°01'18.6994"N
83°21'48.5483"W



Google Earth

© 2020 Google

519

3036

2000 ft



4



230 Swartz Drive • Hazard • Kentucky • 41701

Phone (606) 551-1050

EAST KENTUCKY ENGINEERING, LLC.

**APPALACHIAN WIRELESS
Geotechnical Investigation on the
Hickory Grove Tower Site
Morgan County, Kentucky
EKYENG Project No. 165-000-0100**

PREPARED FOR:

Appalachian Wireless.
101 Technology Trail
Ivel, Kentucky 41642

PREPARED BY:

Richard Dirk Smith PE, PLS
President
East Kentucky Engineering
230 Swartz Drive
Hazard, Kentucky 41701



_____, 20215, March 4th, 2020



EAST KENTUCKY ENGINEERING, LLC.

EXECUTIVE SUMMARY

1.0 INTRODUCTION

2.0 PROJECT DESCRIPTION

3.0 SITE DESCRIPTION & HISTORICAL MINING

3.1 GENERAL INFORMATION

3.2 SURFACE MINING

3.3 UNDERGROUND MINING

3.4 FLOOD HAZARD

4.0 FIELD EXPLORATION

4.1 SITE INFORMATION

4.2 BORING DATA

4.3 GROUNDWATER

4.4 SEISMIC SITE CLASSIFICATION

5.0 DISCUSSION AND RECOMMENDATIONS

5.1 GENERAL

5.2 SHALLOW MAT FOUNDATIONS RECOMMENDATIONS

5.3 BURIED UTILITIES

6.0 WARRANTY

6.1 SUBSURFACE EXPLORATION

6.2 LABORATORY AND FIELD TEST

6.3 ANALYSIS AND RECOMMENDATIONS

6.4 CONSTRUCTION MONITORING

6.5 GENERAL

SPECIFICATIONS

I – GENERAL

II – ENGINEERED FILL BENEATH STRUCTURES CLEARING AND GRADING SPECIFICATIONS

III – GUIDELINES FOR EXCAVATIONS AND TRENCHING

IV – GENERAL CONCRETE SPECIFICATIONS

V – DRILLED PIER INSTALLATION

APPENDIX A – BORING LOGS

APPENDIX B – CORE PHOTOGRAPHS

APPENDIX C – SEISMIC DATA

APPENDIX D – PHOTOGRAPHS

APPENDIX E – MAPS



EAST KENTUCKY ENGINEERING, LLC.

EXECUTIVE SUMMARY

A geotechnical investigation has been performed on the Hickory Grove Tower Site, located in Morgan County, Kentucky. This site is readily accessible. A location map is shown in Figure 1 of this report. Four (4) borings were advanced to a maximum depth of 25.0 ft. The following geotechnical considerations were identified:

- Borings utilized for this study encountered thin soils with clays immediately below to a depth of 5.8 ft., then weathered shale from 5.8 to 25.0 ft.
- The estimated maximum base elevation of tower mat foundation is 1137.6 ft. This base elevation has been lowered to place the entire mat on the shale rock
- This site is on a forested knob.
- **The allowable bearing capacities is estimated at 4 tsf on this shale unit from 1138 to 1120.0.**
- The 2015 International Building Code seismic site classification for this site is "A".
- If during the foundation design it becomes necessary to lower or raise the footer, alternate design recommendations can be provided by EKYENG.
- Close monitoring of the construction operations discussed herein will be critical in achieving the design subgrade support. We, therefore, recommend that EKYENG is retained to monitor this portion of the work.

This executive summary is included to provide a general overview of the project and should not be relied upon except for the purpose it was prepared. Please rely on the complete report for the information on the findings, recommendations, and all other concerns.



EAST KENTUCKY ENGINEERING, LLC.

1. INTRODUCTION

East Kentucky Engineering (EKYENG) was retained by Mr. Stanton Neece of Appalachian Wireless to prepare a geotechnical engineering report for the proposed tower site located on the Hickory Grove Property, in Morgan County, Kentucky. A site location map is shown in Figure No. 1.

Four (4) borings were advanced to a maximum depth of 25.0 ft. Horn and Associates, Inc. provided drilling services to obtain these borings. Logs of the borings along with a boring location plan are included in Appendix A and Appendix D. The purpose of these services is to provide information and geotechnical engineering recommendations about subsurface conditions, earthwork, seismic considerations, groundwater conditions and foundation design.

2.0 PROJECT DESCRIPTION

The proposed communication facility will consist of a self-supporting tower of undetermined height and ancillary support areas. The footing area is estimated to be 43.5 ft. X 43.5 ft. with an estimated base of the tower footer elevation at 1137.6 ft. Based on information provided, we estimate the structural loads will be like the following conditions.

CONDITION	LOAD
Total Shear	40 Kips
Axial Load	50 Kips

We anticipate that overturning will govern the structural design. If the loading is significantly different than these expected values, EKYENG should be notified to re-evaluate the recommendations provided in this report.

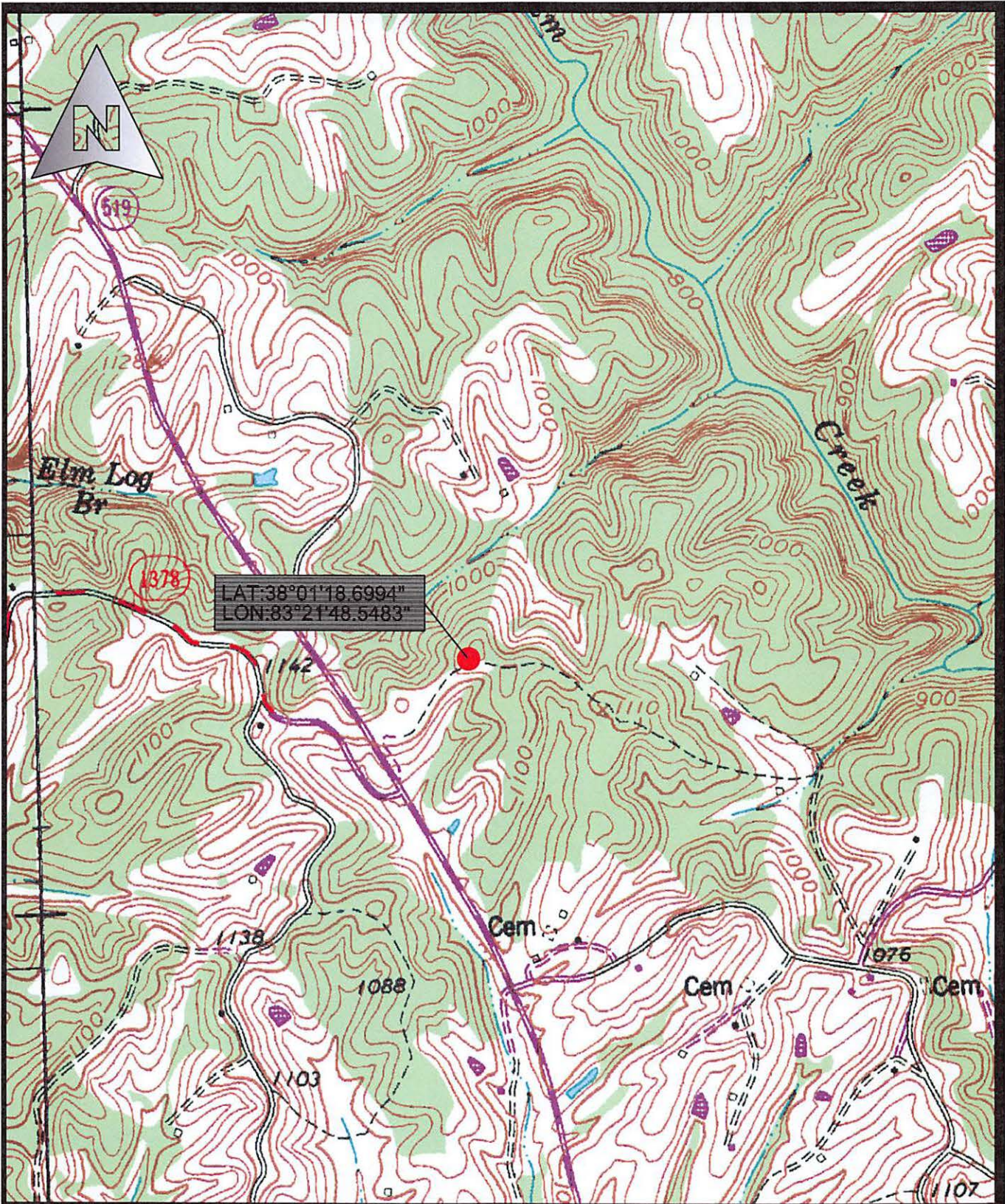

LAT: 38°01'18.6994"
 LON: 83°21'48.5483"

Drawn: RDS	Date: 2/19/2020
Job: 165-100	Scale: 1"=1000'

APPALACHIAN WIRELESS
 EXCERPT FROM USGS QUAD
 LOCATION MAP
 HICKORY GROVE TOWER SITE
 FIGURE NO 1

East Kentucky Engineering, LLC.
 230 Swartz Drive
 Hazard, KY 41701
 (606) 551-1050



EAST KENTUCKY ENGINEERING, LLC.

3.0 SITE DESCRIPTION & HISTORICAL MINING

3.1 GENERAL INFORMATION

The site location is on a forested knob in Morgan County, Kentucky. The current surface elevation is approximately 1149.3 ft. Research on the historical mining was conducted by obtaining previous mine license maps from the "Kentucky Mine Mapping Information System" (KMMIS).

3.2 SURFACE MINING

No issues from surface mining activities are expected at this site location.

3.3 UNDERGROUND MINING

No underground mines were found within the vicinity of this site. Therefore, no subsidence issues are anticipated.

3.4 FLOOD HAZARD

A potential flood determination was conducted by EKYENG. For this determination, the FEMA Flood Map Service was reviewed for this location. The flood map for the selected area is number **21175C0050C-210292**. The flood zone for this area is Zone X and is an area of minimal flood hazard. A FIRMette map is included in Appendix E of this report.

4.0 FIELD EXPLORATION

4.1 SITE INFORMATION

The proposed site is located on a forested knob in Morgan County, Kentucky. The site lies within the Wrigley Quadrangle. The site is readily accessible by conventional exploratory equipment. An estimated pad location was determined based on the information provided. Foundation dimensions were estimated to be a 43.5 ft. X 43.5 ft. footer for this report.

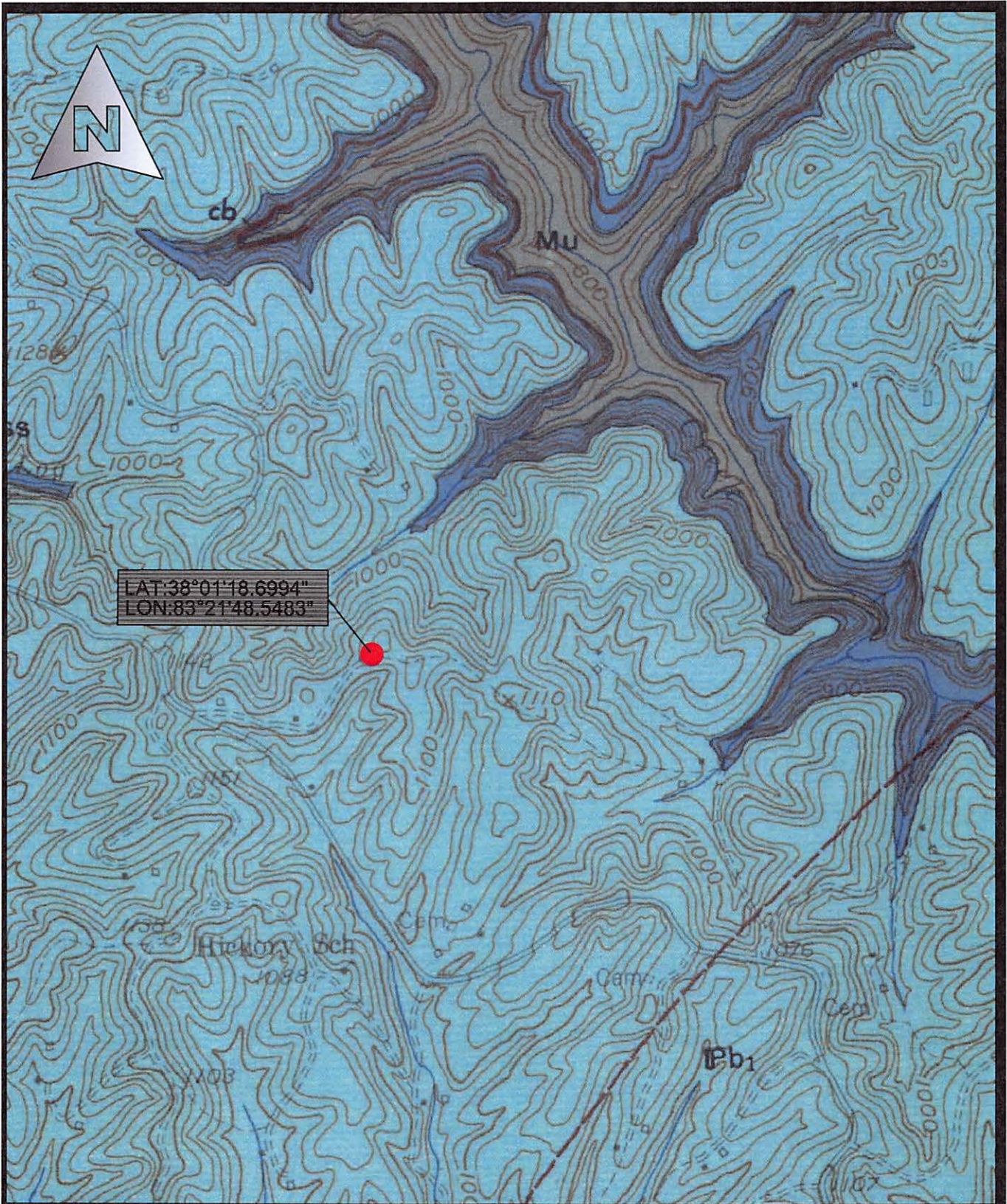

LAT: 38°01'18.6994"
 LON: 83°21'48.5483"

Drawn: RDS	Date: 2/19/2020
Job: 165-100	Scale: 1"=1000'

APPALACHIAN WIRELESS
 EXCERPT FROM GEOLOGIC QUAD
 LOCATION MAP
 HICKORY GROVE TOWER SITE
 FIGURE NO 2

East Kentucky Engineering, LLC.
 230 Swartz Drive
 Hazard, KY 41701
 (606) 551-1050



EAST KENTUCKY ENGINEERING, LLC.

4.2 BORING DATA

Four (4) borings were made in the relative positions shown on the Site Map in Appendix D. The boring logs and resulting data are included in Appendix A. These borings were made with a track mounted boring rig using hollow-stem augers and employing standard penetration resistance methods (ASTM D-1586, which includes 140-pound hammer, 30-inch drop, and two-inch-O.D. split-spoon sampler) at maximum depth intervals of five feet or at major changes in stratum, whichever occurred first. The disturbed split-spoon samples were visually classified, logged, sealed in moisture-proof jars, and taken to the EKYENG laboratory for study. The depths where these "A"-type split-spoon samples were collected are noted on the boring logs. The results of the natural moisture contents by boring and interval are shown in Table 2.

TABLE 2
RESULTS OF NATURAL MOISTURE CONTENT TESTS (ASTM D-4643)

SAMPLE NO.	DEPTH INCREMENT, (FT.)	NATURAL MOISTURE CONTENT, %
B1 S-1	0.0 – 1.5	17.8%
B1 S-2	2.0 – 3.5	15.7%
B1 S-3	4.5 – 6.0	17.9%
B1 S-4	7.0 – 8.5	15.7%
B1 S-5	9.5 – 11.0	13.4%
B2 S-1	0.0 – 1.5	11.2%
B2 S-2	2.0 – 3.5	15.7%
B2 S-3	4.0 – 5.5	11.8%



EAST KENTUCKY ENGINEERING, LLC.

B3 S-1	0.0 – 1.5	8.4%
B3 S-2	2.0 – 3.5	15.9%
B3 S-3	4.5 – 6.0	11.4%
B3 S-4	7.0 – 8.5	10.7%
B4 S-1	0.0 – 1.5	8.1%
B4 S-2	2.0 – 3.5	13.2%
B4 S-3	4.5 – 6.0	11.7%
B4 S-4	7.0 – 8.5	10.3%

The position at which the core was taken is indicated on the boring logs and shown on the sitemap in Appendix D. The corresponding blow counts are shown in Table No. 3.

TABLE NO. 3
STANDARD PENETRATIONS

SAMPLE NO.	DEPTH INCREMENT	BLOW COUNT / RQD *	DESCRIPTION
B-1	0.0-1.5	1-1-1	Topsoil, Red Clay
B-1	2.0-3.5	2-3-5	Red Clay
B-1	4.5-6.0	3-4-4	Brown/ Red Weathered Shale
B-1	7.0-8.5	5-8-9	Brown/ Red Weathered Shale
B-1	9.5-11.0	6-12-20	Gray Weathered Shale
B-1	11.0-16.0	1.7*	Gray Weathered Shale
B-1	16.0-25.0	8.3*	Gray Weathered Shale
B-2	0.0-1.5	1-2-2	Topsoil, Brown Clay
B-2	2.0-3.5	2-3-4	Brown Clay



EAST KENTUCKY ENGINEERING, LLC.

SAMPLE NO.	DEPTH INCREMENT	BLOW COUNT / RQD *	DESCRIPTION
B-2	4.0-5.5	20-50/5	Brown Clay, Brown Weathered Shale
B-2	5.5-15.0	6.8*	Brown Weathered Shale, Gray Weathered Shale
B-2	15.0-25.0	2.5*	Gray Weathered Shale
B-3	0.0-1.5	2-3-2	Topsoil, Brown and Red Clay
B-3	2.0-3.5	2-3-3	Brown and Red Clay
B-3	4.5-6.0	5-15-21	Brown and Red Clay
B-3	7.0-8.5	12-19-40	Brown Weathered Shale
B-3	9.5-15.0	4.4*	Brown Weathered Shale
B-3	15.0-25.0	4.1*	Lost, Brown Weathered Shale, Gray Weathered Shale
B-4	0.0-1.5	1-2-2	Topsoil, Red Clay
B-4	2.0-3.5	1-2-5	Red Clay
B-4	4.5-6.0	6-9-13	Red Clay, Brown-Red Weathered Shale
B-4	7.0-8.5	6-12-19	Brown-Red Weathered Shale
B-4	9.5-15.0	4.0*	Gray Weathered Shale
B-4	15.0-25.0	6.7*	Gray Weathered Shale

The borings encountered sandy clays to a depth of 5.8 ft. The four borings were extended by “NX” size rock core that were taken to confirm the presence of rock at the site and to determine its physical characteristics. The core was made with “NX” size diamond coring equipment. These borings are between 5.5 ft and 25.0 ft in depth. The position at which the core was taken is indicated on the boring logs and shown on the boring location map in Appendix D.

4.3 GROUNDWATER

Groundwater in Eastern Kentucky is characterized by water flowing through a system of internal fractures that lead to an alluvial aquifer near the bottom of valley floors. Large, defined aquifers other than the alluvium is not common, especially in



EAST KENTUCKY ENGINEERING, LLC.

higher elevations such as where this tower site is proposed. Therefore, groundwater should not be a concern in this area. During the site investigation, no groundwater resources were observed.

4.4 SEISMIC SITE CLASSIFICATION

Based on the encountered soil conditions at the project site, the site classification was determined to be "Site Class A" per the 2015 Kentucky Building Code. In addition, an S_{DS} coefficient of 0.101 g was calculated, and an S_{D1} coefficient of 0.045 g was also calculated for design based on the aforementioned building code.

5.0 DISCUSSION AND RECOMMENDATIONS

5.1 GENERAL

The structure will be tri-pole tower with a mat base foundation. Due to wind loading, lattice tower foundations can experience both vertical loads and horizontal loads. The vertical loads act in both an upward and downward direction as the tower attempts to overturn and can act in any directions.

5.2 SHALLOW MAT FOUNDATIONS RECOMMENDATIONS

It is expected that shallow foundations will be used at the base of the proposed tower. It should be noted that the material type and bearing capacity can vary significantly due to the inconsistency of the underlying material. Based on the laboratory and field testing, visual inspection of the materials and practical experience we have estimated that the **allowable bearing capacity at this site will be 4 tsf within the shale unit from an elevation of 1138.0 to 1120.0 ft.**

It is furthermore recommended that the slabs-on-grade be supported on 4 to 6-inch layer of relatively clean granular material such as sand and gravel or crushed stone. This is to help distribute concentrated loads and equalize moisture conditions



EAST KENTUCKY ENGINEERING, LLC.

beneath the slab. Proper drainage must be incorporated into this granular layer to preclude future wet areas in the finished slab-on-grade. However, all topsoil and/or other deleterious materials encountered during site preparation must be removed and replaced with 4000 psi. concrete below the foundation base. Provided that a minimum of 4 inches of granular material is placed below the new slab-on-grade, a modulus of subgrade reaction (k30) of 100 lbs./cu. in. can be used for design of the slabs.

Support structure for this tower can be placed as needed. It is recommended that test pits are examined to ensure that any of these structures are on the competent materials. If pockets of soft, loose or otherwise unsuitable material are encountered in the footing excavations and it is inconvenient to lower the footings, the proposed footing elevations may be re-established by backfilling after the undesirable material has been removed. The undercut excavation beneath each footing should extend to suitable bearing soils and the dimensions of the excavation base should be determined by imaginary planes extending outward and down on a 1 (vertical) to 1 (horizontal) slope from the base perimeter of the footing. The entire excavation should then be refilled with a well-compacted engineered fill, or lean concrete (Please note that the width of the lean concrete zone should be equal or wider than the width of the overlying footing element). Special care should be exercised to remove any sloughed, loose or soft materials near the base of the excavation slopes. In addition, special care should be taken to "tie-in" the compacted fill with the excavation slopes, with benches as necessary, to ensure that no pockets of loose or soft materials will be left in place along the excavation slopes below the foundation bearing level. All Federal, State, and Local regulations should be strictly adhered to relative to excavation side-slope geometry.

5.3 BURIED UTILITIES

Excavations for buried utility pipelines should follow the guidelines set forth in this report. Depending on the pipeline material, a minimum thickness of at least 0.5 feet of select fine-grained granular bedding material should be used beneath all below-



EAST KENTUCKY ENGINEERING, LLC.

grade pipes, with a minimum cover thickness of at least 3 feet to afford an "arching" effect and reduce stresses on the pipe. The cover thickness may be reduced if the external loading condition on the pipe is relatively light or if the pipe is designed to withstand the external loading condition. It is not recommended that "pea-gravel" or other "open-work" aggregates be used for trench backfill since these materials are nearly impossible to compact and tend to pond water within their interstices.

6.0 WARRANTY

Our professional services have been performed, our findings obtained, and our recommendations prepared in accordance with generally accepted geotechnical engineering principles and practices. No other warranty, express or implied, is made.

While the services of EKYENG are a valuable and integral part of the design and construction teams, we do not warrant, guarantee, or insure the quality or completeness of services provided by other members of those teams, the quality, completeness, or satisfactory performance of construction plans and specifications which we have not prepared, nor the ultimate performance of building site materials.

6.1 SUBSURFACE EXPLORATION

Subsurface exploration is normally accomplished by test borings, although test pits are sometimes employed. The method of determining the boring location and the surface elevation at the boring is noted in the report and is presented on the Boring Location Plan or on the boring log. The location and elevation of the boring should be considered accurate only to the degree inherent with the method used.

The boring log includes sampling information, description of the materials recovered, approximate depth of boundaries between soil and rock strata and groundwater data. The boring log represents conditions specifically at the location and time the boring was made. The boundaries between different soil strata are



EAST KENTUCKY ENGINEERING, LLC.

indicated at specific depths; however, these depths are in fact approximate and are somewhat dependent upon the frequency of sampling (The transition between soil strata is often gradual). Free groundwater level readings are made at the times and under conditions stated on the boring logs (Groundwater levels change with time and season). The borehole does not always remain open sufficiently long enough for the measured water level to coincide with the groundwater table.

6.2 LABORATORY AND FIELD TESTS

Laboratory and field tests are performed by specific ASTM standards unless otherwise indicated. All determinations included in each ASTM standard are not always required and performed. Each test report indicates the measurements and determinations made.

6.3 ANALYSIS AND RECOMMENDATIONS

The geotechnical report is prepared primarily to aid in the engineering design of site work and structural foundations. Although the information in the report is expected to be sufficient for these purposes, it is not intended to determine the cost of construction or to stand alone as a construction specification.

Our engineering report recommendations are based primarily on data from test borings made at the locations shown in a boring location drawing included. Soil variations may exist between borings, and these variations may not become evident until construction. If significant variations are then noted, the geotechnical engineer should be contacted so that field conditions can be examined and recommendations revised if necessary.

The geotechnical engineering report states our understanding as to the location, dimensions and structural features proposed for the site. Any significant changes in the nature, design, or location of the site improvements **MUST** be communicated to the geotechnical engineer such that the geotechnical analysis, conclusions, and recommendations can be appropriately adjusted. The geotechnical engineer



EAST KENTUCKY ENGINEERING, LLC.

should be given the opportunity to review all drawings that have been prepared based on their recommendations.

6.4 CONSTRUCTION MONITORING

Construction monitoring is a vital element of complete geotechnical services. The field engineer/inspector is the owner's "representative" observing the work of the contractor, performing tests as required in the specifications, and reporting data developed from such tests and observations. The field engineer or inspector does not direct the contractor's construction means, methods, operations or personnel. The field inspector/engineer does not interfere with the relationship between the owner and the contractor and, except as an observer, does not become a substitute owner on site. The field inspector/engineer is responsible for his own safety but has no responsibility for the safety of other personnel at the site. The field inspector/engineer is an important member of a team whose responsibility is to watch and test the work being done and report to the owner whether that work is being carried out in general conformance with the plans and specifications.

6.5 GENERAL

The scope of our services did not include an environmental assessment for the presence or absence of hazardous or toxic materials in the soil, surface water, groundwater or air, on, within or beyond the site studied. Any statements in the report or on the boring logs regarding odors, staining of soils or other unusual items or conditions observed are strictly for the information of our client.

To evaluate the site for possible environmental liabilities, we recommend an environmental assessment, consisting of a detailed site reconnaissance, a record review, and report of findings. Additional subsurface drilling and samplings, including groundwater sampling, may be required.

This report has been prepared for the exclusive use of Appalachian Wireless, for specific application to the proposed cellular tower located on the Hickory Grove



EAST KENTUCKY ENGINEERING, LLC.

Property located in Morgan County, Kentucky. Specific design and construction recommendations have been provided in the various sections of the report. The report shall, therefore, be used in its entirety. This report is not a bidding document and shall not be used for that purpose. Anyone reviewing this report must interpret and draw their conclusions regarding specific construction techniques and methods that were chosen. EKYENG is not responsible for the independent conclusions, opinions or recommendations made by others based on the field exploratory and laboratory test data presented in this report.



EAST KENTUCKY ENGINEERING, LLC.

SPECIFICATIONS

I – GENERAL

1.0 STANDARDS AND DEFINITIONS

1.1 STANDARDS - All standards refer to latest edition unless otherwise noted.

1.1.1 ASTM D-698-70 (Method C) "Standard Test Methods for Moisture, Density Relations of Soils and Soil Aggregate Mixtures Using 5.5-lb (2.5 kg.) Rammer and 12-inch (305-mm) Drop".

1.1.2 ASTM D-2922 "Standard Test Method for Density of Soil and Soil Aggregate in Place by Nuclear methods (Shallow Depth)".

1.1.3 ASTM D-1556 "Standard Test Method for Density of Soil in place by the Sand-Cone Method".

1.2 DEFINITIONS

1.2.1 Owner - In these specifications the word "Owner" shall mean Appalachian Wireless.

1.2.2 Engineer - In these specifications the word "Engineer" shall mean the Owner designated engineer.

1.2.3 Design Engineer - In these specifications the words "Design Engineer" shall mean the Owner designated design engineer.

1.2.4 Contractor - In these specifications the word "Contractor" shall mean the firm or corporation undertaking the execution of any work under the terms of these specifications.

1.2.5 Approved - In these specifications the word "approved" shall refer to the approval of the Engineer or his designated representative.

1.2.6 As Directed - In these specifications the words "as directed" shall refer to the directions to the Contractor from the Owner or his designated representative.



EAST KENTUCKY ENGINEERING, LLC.

2.0 GENERAL CONDITIONS

- 2.1** The Contractor shall furnish all labor, material and equipment and perform all work and services except those set out and furnished by the Owner, necessary to complete in a satisfactory manner the site preparation, excavation, filling, compaction, grading as shown on the plans and as described therein.

This work shall consist of all mobilization clearing and grading, grubbing, stripping, removal of existing material unless otherwise stated, preparation of the land to be filled, filling of the land, spreading and compaction of the fill, and all subsidiary work necessary to complete the grading of the cut and fill areas to conform with the lines, grades, slopes, and specifications.

This work is to be accomplished under the observation of the Owner or his designated representative.

- 2.2** Prior to bidding the work, the Contractor shall examine, investigate and inspect the construction site as to the nature and location of the work, and the general and local conditions at the construction site, including, without limitation, the character of surface or subsurface conditions and obstacles to be encountered on and around the construction site; and shall make such additional investigation as he may deem necessary for the planning and proper execution of the work.

If conditions other than those indicated are discovered by the Contractor, the Owner should be notified immediately. The material which the Contractor believes to be a changed condition should not be disturbed so that the owner can investigate the condition.

- 2.3** The construction shall be performed under the direction of an experienced engineer who is familiar with the design plan.



EAST KENTUCKY ENGINEERING, LLC.

II - ENGINEERED FILL BENEATH STRUCTURES CLEARING AND GRADING SPECIFICATIONS

1.0 GENERAL CONDITIONS

The Contractor shall furnish all labor, materials, and equipment, and perform all work and services necessary to complete in a satisfactory manner the site preparation, excavation, filling, compaction and grading as shown on the plans and as described therein.

This work shall consist of all clearing and grading, removal of existing structures unless otherwise stated, preparation of the land to be filled, filling of the land, spreading and compaction of the fill, and all subsidiary work necessary to complete the grading of the cut and fill areas to conform with the lines, grades, slopes, and specifications.

This work is to be accomplished under the constant and continuous supervision of the Owner or his designated representative.

In these specifications, the terms "approved" and "as directed" shall refer to directions to the Contractor from the Owner or his designated representative.

2.0 SUBSURFACE CONDITIONS

Prior to bidding the work, the Contractor shall examine, investigate and inspect the construction site as to the nature and location of the work, and the general and local conditions at the construction site, including without limitation, the character of surface or subsurface conditions and obstacles to be encountered on and around the construction site; and shall make such additional investigation as he may deem necessary for the planning and proper execution of the work. Borings and/or soil investigations shall have been made. Results of these borings and studies will be made available by the Owner to the Contractor upon his request, but the Owner is not responsible for any interpretations or conclusions with respect thereto made by the Contractor based on such information, and the Owner further has no responsibility for the accuracy of the borings and the soil investigations.

If conditions other than those indicated are discovered by the Contractor, the Owner should be notified immediately. The material which the Contractor believes to be a changed condition should not be disturbed so that the Owner can investigate the condition.

3.0 SITE PREPARATION

Within the specified areas, all trees, brush, stumps, logs, tree roots, and structures scheduled for demolition shall be removed and disposed of.

All cut and fill areas shall be properly stripped. Topsoil will be removed to its full depth and stockpiled for use in finish grading. Any rubbish, organic and other objectionable soils, and other deleterious material shall be disposed of off the site, or as directed by the Owner or his designated representative if on site disposal is



EAST KENTUCKY ENGINEERING, LLC.

provided. In no case shall such objectionable material be allowed in or under the fill unless specifically authorized in writing.

Prior to the addition of fill, the original ground shall be compacted to job specifications as outlined below. Special notice shall be given to the proposed fill area now. If wet spots, spongy conditions, or groundwater seepage is found, corrective measures must be taken before the placement of fill.

4.0 FORMATION OF FILL AREAS

Fills shall be formed of satisfactory materials placed in successive horizontal layers of not more than eight (8) inches in loose depth for the full width of the cross-section. The depth of lift may be increased if the Contractor can demonstrate the ability to compact a larger lift. If compaction is accomplished using hand-tamping equipment, lifts will be limited to 4-inch loose lifts. Engineered fill placed below the structure bearing elevation shall be compacted to at least 95% of the maximum dry unit weight with a moisture content within 2% of the optimum moisture content as determined by the modified Proctor test. The top size of the material placed shall not exceed 4 inches.

All material entering the fill shall be free of organic matter such as leaves, grass, roots, and other objectionable material.

The operations on earth work shall be suspended at any time when satisfactory results cannot be obtained because of rain, freezing weather, or other unsatisfactory conditions. The Contractor shall keep the work areas graded to provide the drainage always.

The fill material shall be of the proper moisture content before compaction efforts are started. Wetting or drying of the material and manipulation to secure a uniform moisture content throughout the layer shall be required. Should the material be too wet to permit proper compaction or rolling, all work thus affected shall be delayed until the material has dried to the required moisture content. The moisture content of the fill material should be no more than two (2) percentage points higher or lower than optimum unless otherwise authorized. Sprinkling shall be done with equipment that will satisfactorily distribute the water over the disced area. Any areas inaccessible to a roller shall be consolidated and compacted by mechanical tampers. The equipment shall be operated in such a manner that hardpan, cemented gravel, clay or other chunky soil material will be broken up into small particles and become incorporated with the other material in the layer.

In the construction of filled areas, starting layers shall be placed in the deepest portion of the fill, and as placement progresses, additional layers shall be constructed in horizontal planes. Original slopes shall be continuously, vertically benched to provide horizontal fill planes. The size of the benches shall be formed so that the base of the bench is horizontal, and the back of the bench is vertical. As many benches as are necessary to bring the site to final grade shall be constructed. Filling operations shall begin on the lowest bench, with the fill being



EAST KENTUCKY ENGINEERING, LLC.

placed in horizontal eight (8) inch thick loose lifts unless otherwise authorized. The filling shall progress in this manner until the entire first bench has been filled, before any fill is placed on the succeeding benches. Proper drainage shall be maintained always during benching and filling of the benches, to ensure that all water is drained away from the fill area.

Frozen material shall not be placed in the fill nor shall the fill be placed upon frozen material.

The Contractor shall be responsible for the stability of all fills made under the contract, and shall replace any portion, which in the opinion of the Owner or his designated representative, has become displaced due to carelessness or negligence on the part of the Contractor. Fill damaged by inclement weather shall be repaired at the Contractor's expense.

5.0 SLOPE RATIO AND STORM WATER RUN-OFF

Slopes shall not be greater than 2 (horizontal) to 1 (vertical) in both cut and fill, or as illustrated on the construction drawings. Excavations shall be constructed in accordance with all Federal, State and local codes relative to slope geometry.

6.0 GRADING

The Contractor shall furnish, operate, and maintain such equipment as is necessary to construct uniform layers, and control smoothness of grade for maximum compaction and drainage.

7.0 COMPACTING

The compaction equipment shall be approved equipment of such design, weight, and quantity to obtain the required density in accordance with these specifications.

8.0 TESTING AND INSPECTION SERVICES

Testing and inspection services will be provided by the Owner.



EAST KENTUCKY ENGINEERING, LLC.

GUIDELINES FOR EXCAVATIONS AND TRENCHES

The following represents some general guidelines relative to the design and construction of excavations and trenches. It must be emphasized that these guidelines are not intended to represent a "safety plan," but rather are presented herein to provide general guidance regarding the design characteristics and safety measures for excavations and trenches.

1. Check with the following utilities prior to breaking ground:

- Sewer
- Telephone
- Fuel
- Electric
- Water
- Gas
- Cable

When utility companies or owners do not respond to your request within 48 hours, the contractor may only then proceed provided the contractor does so with caution by using detection equipment or other acceptable means to locate utility installations.

Once the excavation is open, the contractor should protect and support the exposed underground utilities or remove installations to safeguard workers and prevent damage to exposed utilities.

- 2. Access and egress ramps must be designed by a "competent person" and structural ramps used for equipment must be designed by a "competent person" with qualified knowledge in structural design. In addition:**
- Ramps must be secured to prevent displacement;
 - Ramps used in lieu of steps must have cleats to prevent slipping; and
 - Trenching excavations four feet or greater in depth must have a stairway, ladder, ramps or other safe means to egress with lateral travel no more than 25 feet.
- 3. Workers must be provided with reflector garments, such as warning orange or red vests, when exposed to vehicular traffic.**
- 4. Contractors must not allow workers to work under or near equipment when there is danger of falling debris, spillage or equipment-related injuries.**



EAST KENTUCKY ENGINEERING, LLC.

- 5.** Mobile equipment, operating adjacent to an open excavation or approaching the edge of an excavation, must have one of the following when the operator's view is obstructed:
 - Warning System
 - Mechanical Signals
 - Barricades
 - Stop Logs
 - Hand Signals
- 6.** The contractor must check the atmosphere for hazardous gases and oxygen deficiencies when excavating four feet or greater around landfills, or when hazardous substances are stored nearby, and when the contractor expects there could be any exposure to the workers.
- 7.** When hazardous atmospheric conditions exist, or when conditions could change, the contractor must make emergency rescue equipment readily available including breathing apparatus, safety harnesses with life lines and a basket stretcher.
- 8.** When workers enter bell-bottom pier holes or other deep and confined excavations, the worker must wear (always while performing work in the confined space) a separate life line attached to a harness. The line must be attended by someone above while work is being performed. The worker must check for hazardous atmospheric conditions prior to entry.
- 9.** The contractor must ensure that water does not accumulate in open excavations and must inspect the excavation prior to allowing workers to re-enter after heavy rains.
- 10.** Adjacent structures (buildings, walls, etc.) must be supported or secured to prevent worker exposure to unsafe conditions and damage to existing structures.
- 11.** A registered professional engineer must approve operations when a contractor underpins existing structures to ensure worker safety and prevent damage to existing structures.
- 12.** Workers must not be exposed to loose soil and rock or materials in and around excavations. Materials, such as removed soil and rock, must not be stored closer than two feet from the edge of the excavation.
- 13.** Daily inspections of the excavation, the adjacent areas and protective systems must be made by a "competent person" for evidence of possible cave-ins, indications of failure of protective systems, hazardous atmospheres or other hazardous conditions. The "competent person" must



EAST KENTUCKY ENGINEERING, LLC.

stop work immediately and remove workers from the excavation when conditions change and pose a threat to their safety.

- 14.** Workers must not be exposed to fall hazards associated with excavations. Protective walkways or bridges with standard guard rails must be provided.
- 15.** All wells, pits, shafts etc. must be barricaded or covered. After completion of work, all wells, pits, shafts etc. must be backfilled.



EAST KENTUCKY ENGINEERING, LLC.

IV - GENERAL CONCRETE SPECIFICATIONS

1.0 GENERAL

It is the intent of this specification to secure, for every part of the work, concrete of homogenous structure which, when hardened, will have the required strength and resistance to weathering. To this end, the limiting values of concrete and the requirements hereinafter specified must be met. Standard tests of the cement, aggregates, concrete and reinforcement will be made by the Owner as it sees fit. The Contractor shall furnish the material for all required samples plus such labor as required to obtain samples. The Contractor shall provide to authorized representatives of the Owner, convenient access to all parts of the work of all concreting operations for the purpose of sampling and inspection.

2.0 SCOPE

Contractor shall furnish all materials, labor, services, transportation, tools, equipment, and related items required to complete work indicated on the drawings and/or specified.

Unless otherwise noted or as modified by more stringent requirements specified herein, all plain and reinforced concrete work shall be performed in full compliance with applicable requirements of the Building Code Requirements for Reinforced Concrete ACI 318.

Contractor shall obtain Owner's approval of all subgrades, footing bottoms, forms, and reinforcement just prior to placing concrete.

Contractor shall coordinate the work specified in this section with that specified in other sections so that all anchors, pipes and other embedded items are properly installed before concrete is placed.

Contractor shall clean all exposed concrete surfaces and obtain approval of Owner for method of cleaning

3.0 MATERIALS

All materials shall be of the respective quality specified herein, delivered, stored, and handled as to prevent inclusion of foreign matter and damage by dampness or breakage. Packaged material shall be stored in original container until ready for use. Materials showing evidence of dampness or other damage may be rejected.

A. Fine and Coarse Aggregates: Coarse and fine aggregates shall conform to ASTM Specification C33. The maximum size of aggregate shall not be larger than one-fifth (1/5) of the narrowest dimensions between forms, or larger than three fourths (3/4) of the minimum clear spacing between reinforcement.

1. Fine Aggregate: Sand shall be composed essentially of clean, hard, strong, durable grains free of structurally weak grains, organic matter, loam, clay, silt, salt, mica or other fine materials that may affect bonding of the cement paste.



EAST KENTUCKY ENGINEERING, LLC.

2. Coarse Aggregate: Cement concrete shall consist of crushed rock or screened gravel and shall be composed essentially of clean, hard, strong and impermeable particles, resistant to wear and frost and free from deleterious amounts of organic matter, loam, clay, salts, mica, and soft, thin, elongated, laminated or disintegrated stone, and shall be inert to water and cement.
- B. Portland Cement: Portland cement shall conform to ASTM Specification C150. Type I or Type II Portland Cement shall be used provided that they are not intermixed during any one batch. Type II Portland Cement shall not be used unless indicated on the plans.
- C. Water: Water for mixing and curing shall be clean, fresh, and free from deleterious materials.
- D. Metal Reinforcement: Rebar shall be Grade 60 and with deformations conforming to ASTH Specification A305. Welded wire mesh shall conform to W4 x W4 size and be of Grade 60 steel.
- E. Admixtures: Except as herein noted, admixtures shall not be used.
 1. Under adverse weather conditions only retarding or accelerating agents containing no chloride may be used.
 2. Air-Entraining Agent shall be used for all concrete will give an entrained air range of not less than 4 percent but no greater than 8 percent in the finished product. Under no circumstances shall the air-entraining be interground with cement.
 3. Approval in writing shall be required from Owner prior to the use of any admixture.

4.0 FORM

Forms shall be constructed with proper shoring and cross-bracing, safeguarding the total structure and specifically lateral stability and sufficiently strong to stand vibrations of concrete and to carry, without appreciable deflection or displacement, all dead and live loads to which they may be subjected.

5.0 INSERTS, ETC.

Anchors, bolts, dowels, conduit, water stops, vent pipes and other similar built-in or concreted-in items shall be properly located, accurately positioned and secured. The Contractor shall cooperate in placing of such items with other contractors who require a fastening device for their work and he shall maintain them in proper location during the progress of his work.

6.0 REINFORCEMENT

Reinforcement at the time concrete is placed shall be free from rust, scale or other coatings that will destroy or reduce the bond.



EAST KENTUCKY ENGINEERING, LLC.

Reinforcement shall be accurately placed and securely tied at intersections and shall be securely held in position during the placing of concrete by pacers, chairs, or other approved supports.

The reinforcement of foundations, footings and other principal structural members in which the concrete is deposited against the ground shall not have less than three (3) inches of concrete between it and the ground contact surface. If concrete surfaces after removal of the forms are to be exposed to the weather or to be in contact with the ground or rock, reinforcement shall be protected with not less than two (2) inches of concrete,

7.0 CONCRETE

Concrete for the various parts of the work shall be of 4000 pounds per square inch compressive strength with a minimum 28-day cure. Contractor is responsible to provide a mix of not less than 6 bags of cement per yard of concrete and not more than 7 gallons of water per bag of cement, producing a minimum slump of 2-1/2 inches and a maximum slump of 4-1/2 inches. Concrete that exceeds the above range of maximum or minimum slump requirements may be rejected by the Owner. All concrete shall be air-entrained. Contractors are required to furnish the name or names of the company(s) that will be providing the mix. The Owner reserves the right to disapprove any concrete supplier that has been known to supply an undesirable material to the Owner on previous occasions.

8.0 DEPOSITING CONCRETE

4.1. Preparation for Placing Concrete: Before depositing concrete, the Contractor shall:

1. Remove from space to be occupied by concrete all debris, including snow, ice, and water unless otherwise permitted by Owner.
2. Provide diversion, satisfactory to Owner, of any flow of water to an excavation to avoid washing the freshly deposited concrete.
3. Coat the forms prior to placing of reinforcing steel as required in form work.
4. Secure firmly in correct position, all reinforcement and other items to be encased and remove therefrom all coating including ice and frost.

B. Transportation of Concrete from Batch Plant: The concrete shall be delivered to the site of the work and discharge shall be completed within 90 minutes after addition of the cement and water to the aggregates. Each batch of concrete delivered at the job site shall be accompanied by a time slip issued at the batching plant, bearing the time of charging of the mixer drum with the cement and aggregates.



EAST KENTUCKY ENGINEERING, LLC.

- C. Transporting of Concrete from Mixer to Place of Final Deposit: Transportation shall be done as rapidly as practical by means which shall prevent the separation or loss of the ingredients. If chutes are used, they shall be at a slope not flatter than one vertical to two horizontal. Buggies or carts shall be equipped with pneumatic rubber tires or surfaces of runways shall be sufficiently smooth or both so as not to cause separation or segregation of concrete ingredients. Concrete shall not be allowed to drop freely more than 4 feet. Where greater drops are required, canvas "elephant trunks" or galvanized iron chutes equipped with suitable hopper heads shall be employed and a sufficient number placed to ensure that the concrete may be effectively compacted into horizontal layers not exceeding 12 inches in thickness with minimum lateral movements.
- D. Depositing of Concrete: Depositing of concrete shall:
1. Proceed continuously after once starting until reaching the end of a section of construction joint location shown on the drawings, or as approved by the Owner. The operations shall be conducted so that no concrete is deposited on concrete sufficiently hardened to cause formation of seams, and planes of weakness.
 2. Be as near as practical to its final position in the forms.
 3. Proceed to maintain constantly a top surface which is approximately level.
 4. Be placed before initial set has occurred, and in no event after it has contained its water content for more than 90 minutes.
 5. Be thoroughly worked and compacted by means of suitable tools to provide impermeability, durability and strength and shall be thoroughly worked around reinforcements and embedded items and into corners of forms and to be free from voids, pockets or honeycombing. Care shall be taken to provide impermeability.
- E. Vibration Equipment: Vibration equipment shall be of the appropriate type and shall, always, be adequate in number of units and power of each unit to properly consolidate all concrete.
- F. Monolithic Pours: Proper delivery of concrete shall be the Contractor's responsibility to make a mono-lithic pour without delays and changes of cold joints.

9.0 CURING



EAST KENTUCKY ENGINEERING, LLC.

All concrete work shall be protected from injurious action by the sun, rain, flowing water, frost and other injury and shall be covered with plastic after application of curing compound for three (3) days on pours located above ground.

Contractor shall not remove any formwork for a minimum period of 24 hours after a concrete pour without written approval of the Owner.

10.0 CONCRETE FINISHES

Finishes of all exposed concrete shall be free of defects which impair its durability or adversely affect its appearance. All such surfaces when stripped, shall be uniform in appearance and any surfaces displaying any deviations from adjacent uniform surfaces shall be rejected and subject to removal.

Finished work shall be level and plumb, true to lines, and dimensions. Finished plane surfaces shall be smooth, and as nearly perfect as practical; however, deviations from a true plane shall not exceed 1/8 inch when measured from a 6-foot straight edge placed against the surface to any point on the surface and under the straight edge.

All exposed surfaces shall have defects corrected, protrusions removed, and holes filled.



EAST KENTUCKY ENGINEERING, LLC.

APPENDIX A BORING LOGS



EAST KENTUCKY ENGINEERING, LLC.

APPENDIX B CORE PHOTOGRAPHS

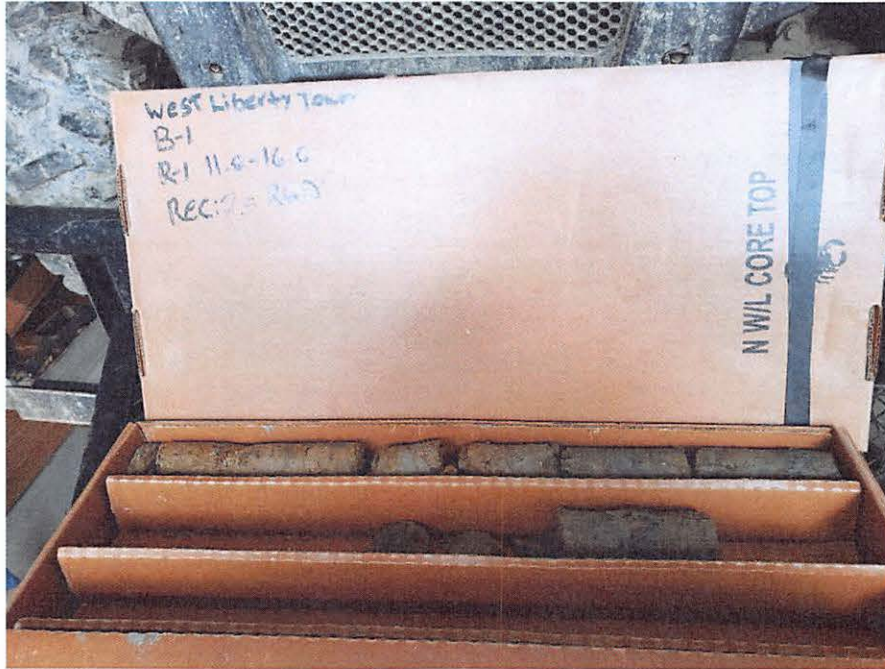



EAST KENTUCKY ENGINEERING, LLC.





EAST KENTUCKY ENGINEERING, LLC.





EAST KENTUCKY ENGINEERING, LLC.





EAST KENTUCKY ENGINEERING, LLC.

APPENDIX C SEISMIC DATA



Hickory Grove Tower

Latitude, Longitude: 38.02186, -83.36349

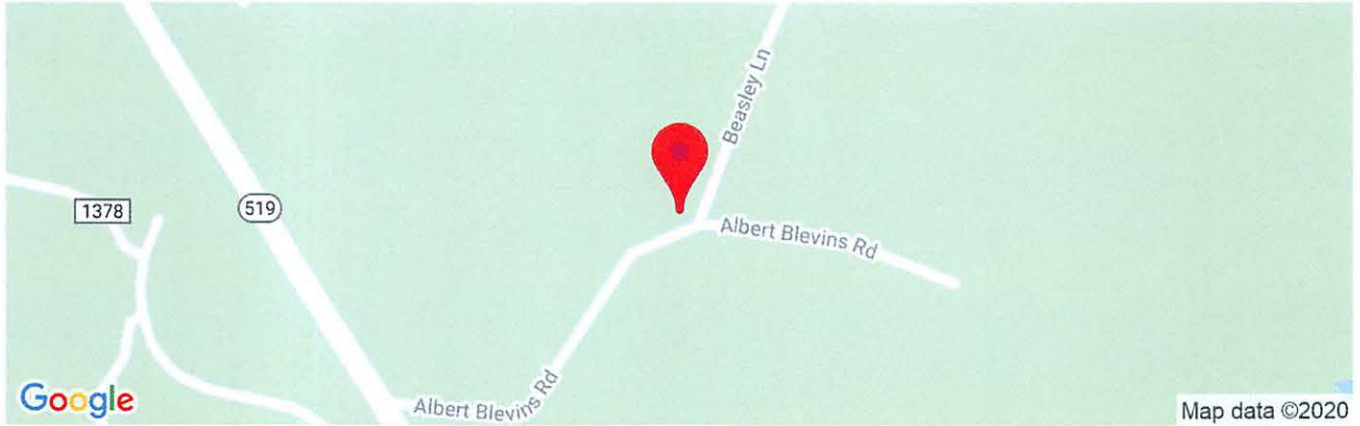

Date	3/5/2020, 3:22:57 PM
Design Code Reference Document	IBC-2015
Risk Category	IV
Site Class	A - Hard Rock

Type	Value	Description
S _S	0.19	MCE _R ground motion. (for 0.2 second period)
S ₁	0.084	MCE _R ground motion. (for 1.0s period)
S _{MS}	0.152	Site-modified spectral acceleration value
S _{M1}	0.067	Site-modified spectral acceleration value
S _{DS}	0.101	Numeric seismic design value at 0.2 second SA
S _{D1}	0.045	Numeric seismic design value at 1.0 second SA

Type	Value	Description
SDC	A	Seismic design category
F _a	0.8	Site amplification factor at 0.2 second
F _v	0.8	Site amplification factor at 1.0 second
PGA	0.094	MCE _G peak ground acceleration
F _{PGA}	0.8	Site amplification factor at PGA
PGA _M	0.076	Site modified peak ground acceleration
T _L	12	Long-period transition period in seconds
SsRT	0.19	Probabilistic risk-targeted ground motion. (0.2 second)
SsUH	0.206	Factored uniform-hazard (2% probability of exceedance in 50 years) spectral acceleration
SsD	1.5	Factored deterministic acceleration value. (0.2 second)
S1RT	0.084	Probabilistic risk-targeted ground motion. (1.0 second)
S1UH	0.093	Factored uniform-hazard (2% probability of exceedance in 50 years) spectral acceleration.
S1D	0.6	Factored deterministic acceleration value. (1.0 second)
PGA _d	0.6	Factored deterministic acceleration value. (Peak Ground Acceleration)
C _{RS}	0.922	Mapped value of the risk coefficient at short periods
C _{R1}	0.903	Mapped value of the risk coefficient at a period of 1 s

DISCLAIMER

While the information presented on this website is believed to be correct, SEAO / OSHPD and its sponsors and contributors assume no responsibility or liability for its accuracy. The material presented in this web application should not be used or relied upon for any specific application without competent examination and verification of its accuracy, suitability and applicability by engineers or other licensed professionals. SEAO / OSHPD do not intend that the use of this information replace the sound judgment of such competent professionals, having experience and knowledge in the field of practice, nor to substitute for the standard of care required of such professionals in interpreting and applying the results of the seismic data provided by this website. Users of the information from this website assume all liability arising from such use. Use of the output of this website does not imply approval by the governing building code bodies responsible for building code approval and interpretation for the building site described by latitude/longitude location in the search results of this website.



EAST KENTUCKY ENGINEERING, LLC.

APPENDIX D PHOTOGRAPHS





EAST KENTUCKY ENGINEERING, LLC.

**APPENDIX E
MAPS**

National Flood Hazard Layer FIRMette



38°1'31.09"N

83°22'7.60"W



USGS The National Map: Orthoimagery. Data refreshed April, 2019

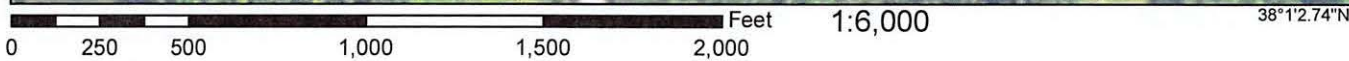

Legend

SEE FIS REPORT FOR DETAILED LEGEND AND INDEX MAP FOR FIRM PANEL LAYOUT

SPECIAL FLOOD HAZARD AREAS		Without Base Flood Elevation (BFE) <i>Zone A, V, A99</i>
		With BFE or Depth <i>Zone AE, AO, AH, VE, AR</i>
		Regulatory Floodway

OTHER AREAS OF FLOOD HAZARD		0.2% Annual Chance Flood Hazard, Areas of 1% annual chance flood with average depth less than one foot or with drainage areas of less than one square mile <i>Zone X</i>
		Future Conditions 1% Annual Chance Flood Hazard <i>Zone X</i>
		Area with Reduced Flood Risk due to Levee. See Notes. <i>Zone X</i>
		Area with Flood Risk due to Levee <i>Zone D</i>

OTHER AREAS		Area of Minimal Flood Hazard <i>Zone X</i>
		Effective LOMRs
		Area of Undetermined Flood Hazard <i>Zone D</i>

GENERAL STRUCTURES		Channel, Culvert, or Storm Sewer
		Levee, Dike, or Floodwall

OTHER FEATURES		Cross Sections with 1% Annual Chance Water Surface Elevation
		Coastal Transect
		Base Flood Elevation Line (BFE)
		Limit of Study
		Jurisdiction Boundary
		Coastal Transect Baseline

MAP PANELS		Digital Data Available
		No Digital Data Available
		Unmapped

The pin displayed on the map is an approximate point selected by the user and does not represent an authoritative property location.

This map complies with FEMA's standards for the use of digital flood maps if it is not void as described below. The basemap shown complies with FEMA's basemap accuracy standards

The flood hazard information is derived directly from the authoritative NFHL web services provided by FEMA. This map was exported on 1/28/2020 at 11:42:06 AM and does not reflect changes or amendments subsequent to this date and time. The NFHL and effective information may change or become superseded by new data over time.

This map image is void if the one or more of the following map elements do not appear: basemap imagery, flood zone labels, legend, scale bar, map creation date, community identifiers, FIRM panel number, and FIRM effective date. Map images for unmapped and unmodernized areas cannot be used for regulatory purposes.

83°21'30.14"W

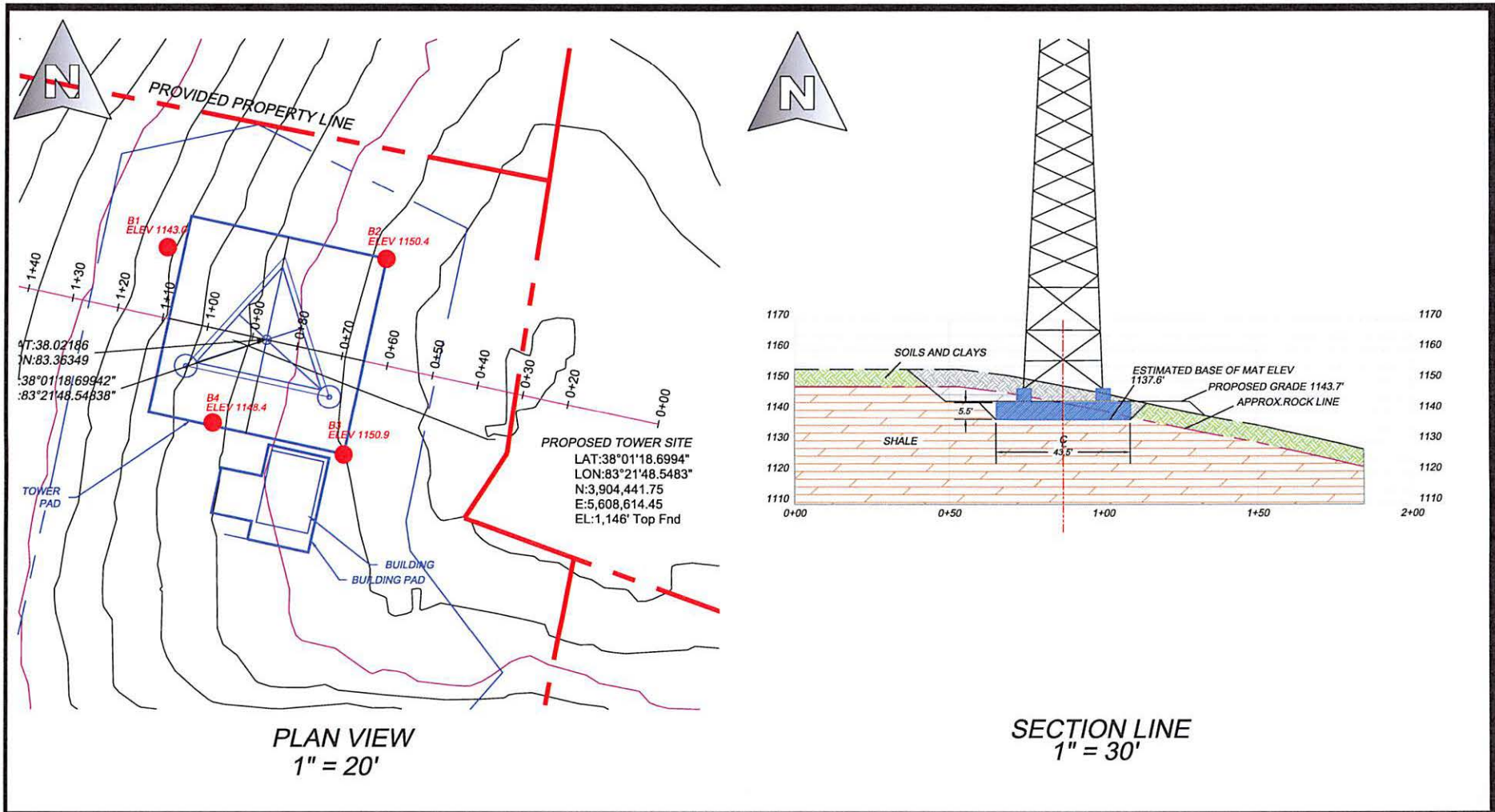

East Kentucky Engineering, LLC

230 Swartz
 Hazard, KY 41701
 (606) 551-1050
 Email: ekyeng@ekyeng.net

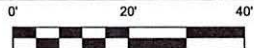

Drawn by: RDS 3/2/2020
 Job #: 165-0100 Scale: 1" = AS NOTED
 File Location:

APPALACHIAN WIRELESS
 PROPOSED TOWER LOCATION
 HICKORY GROVE SITE
 MORGAN COUNTY, KENTUCKY

5



World Tower
COMPANY, INC.

1213 Compressor Drive
P.O. Box 508
Mayfield, KY 42066
270-247-3642
FAX: 270-247-0909
E-mail: worldtower@worldtower.com
Web: www.worldtower.com

300' MODEL WSST TOWER
FOR: EAST KENTUCKY NETWORK
SITE: HICKORY GROVE
MORGAN COUNTY, KY
DESIGN PACKAGE

03/25/2020

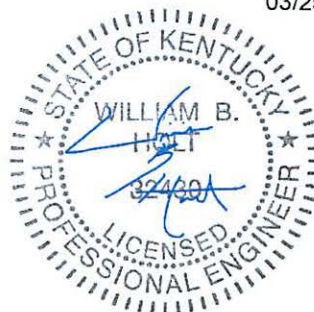

GENERAL NOTES

1. WELDED CONNECTIONS SHALL CONFORM TO THE LATEST REVISION OF THE AMERICAN WELDING SOCIETY AWS. D 1.1.
2. TOWER AND ALL FABRICATED ACCESSORIES ARE HOT-DIP GALVANIZED.
3. ALL BOLTS SHALL BE GALVANIZED ACCORDING TO THE STANDARD SPECIFICATION FOR ZINC COATING OF IRON AND STEEL HARDWARE ASTM A153.
4. LEG STEEL IS 50 KSI MIN YIELD SOLID ROUND OR PIPE AND BRACING STEEL IS 36 KSI MIN YIELD SOLID ROUND OR STRUCTURAL ANGLE.
5. ALL STRUCTURAL BOLTS ARE ASTM A325X, THREADS EXCLUDED FROM SHEAR PLANE.
6. TOWER SHOULD BE INSPECTED IN ACCORDANCE WITH TIA-222-G EVERY 5 YEARS.
7. TOWER INSPECTION SHOULD ONLY BE PERFORMED BY EXPERIENCED QUALIFIED PERSONNEL. FOR ASSISTANCE IN PROPER MAINTENANCE OF YOUR TOWER, CALL WORLD TOWER AT 270-247-3642.

03/25/2020

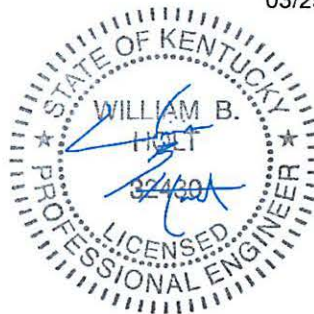

WORLD TOWER			
TITLE: 300' MODEL WSST TOWER FOR: EAST KENTUCKY NETWORK SITE: HICKORY GROVE MORGAN COUNTY, KY			
SCALE	DWN. LKG	CKD.	DATE 3-24-20
FILE	DWG. NO. Q200220N		

03/25/2020

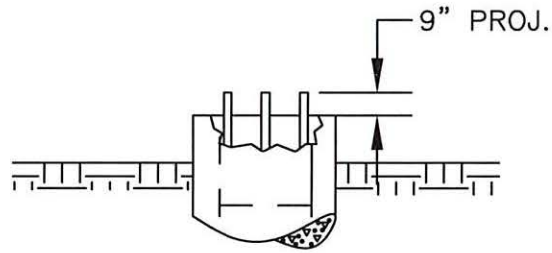
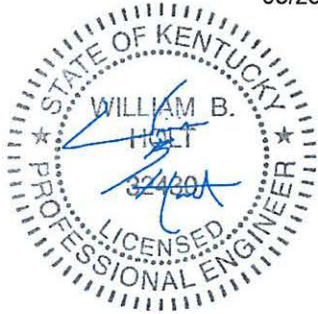

PIER ELEVATION

ANCHOR BOLTS
(6) 1 1/2" ϕ X 78"
ASTM F1554-105
EQUALLY SPACED WITH
TOP TEMPLATE AND
EMBEDDED PLATE

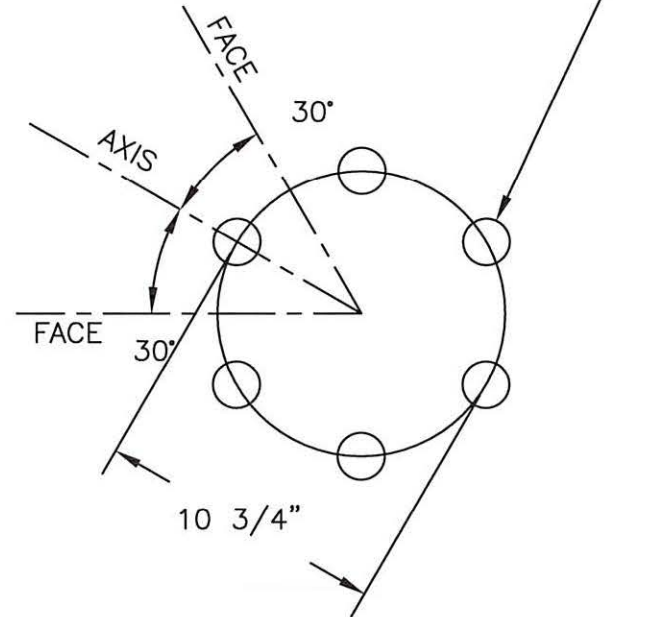
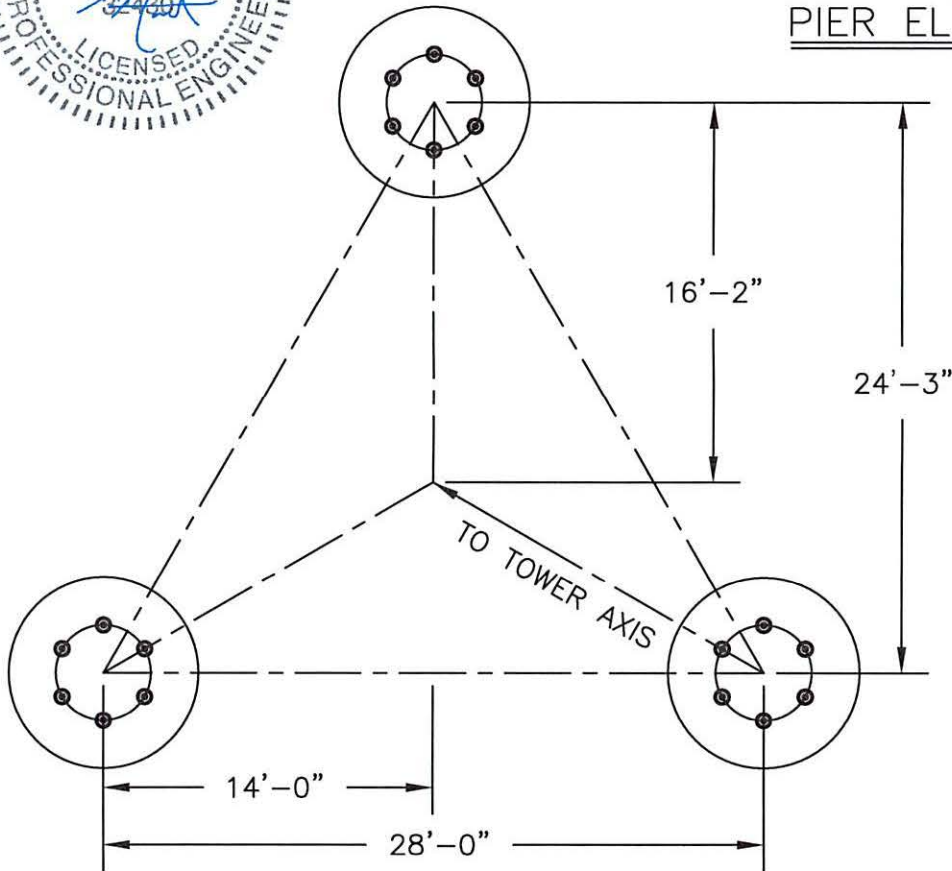

TITLE:

300' MODEL WSST TOWER
FOR: EAST KENTUCKY NETWORK
SITE: HICKORY GROVE
MORGAN COUNTY, KY

WORLD TOWER

SCALE NONE | DWN. LKG | CKD. | DATE 3-24-20

FILE | DWG. NO. Q200220AB

124.5 CU. YDS.
CONCRETE REQ'D.

BASE REACTIONS	
OTM:	14246.0 FT. KIPS
COMP.	623.0 KIPS
UPLIFT	532.0 KIPS
SHEAR (3 LEGS)	83.0 KIPS
WT. NO ICE	107.0 KIPS
WT. 3/4" ICE	328.0 KIPS

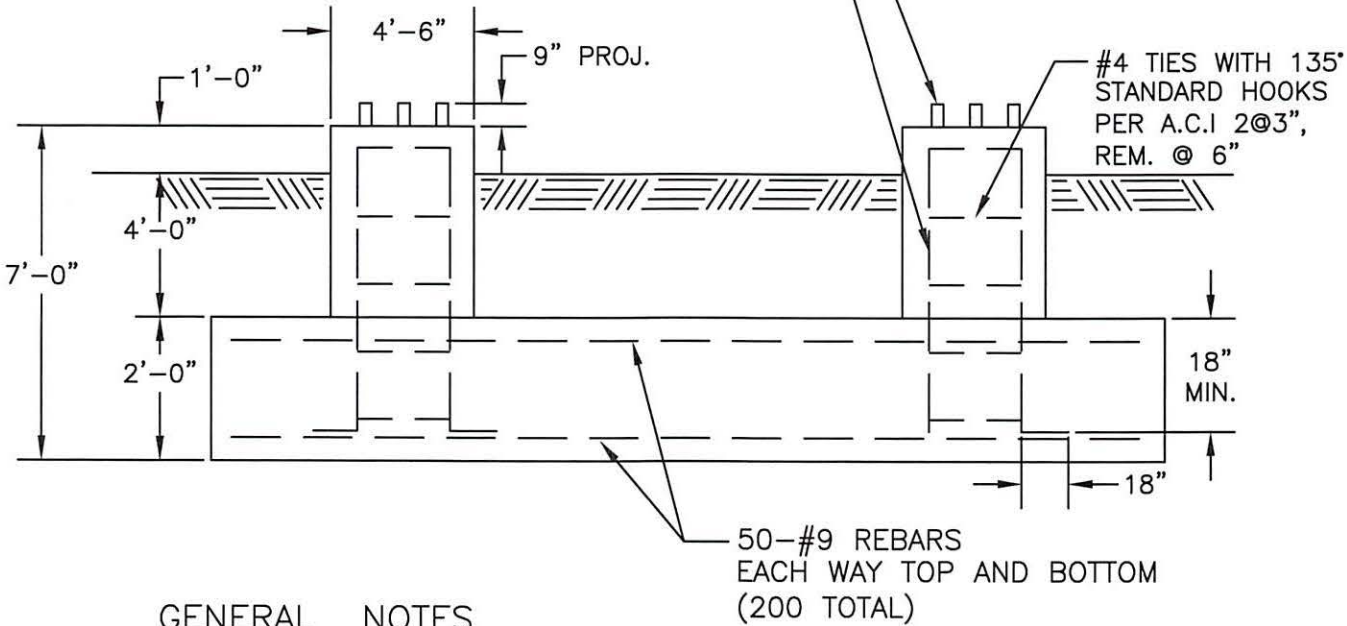
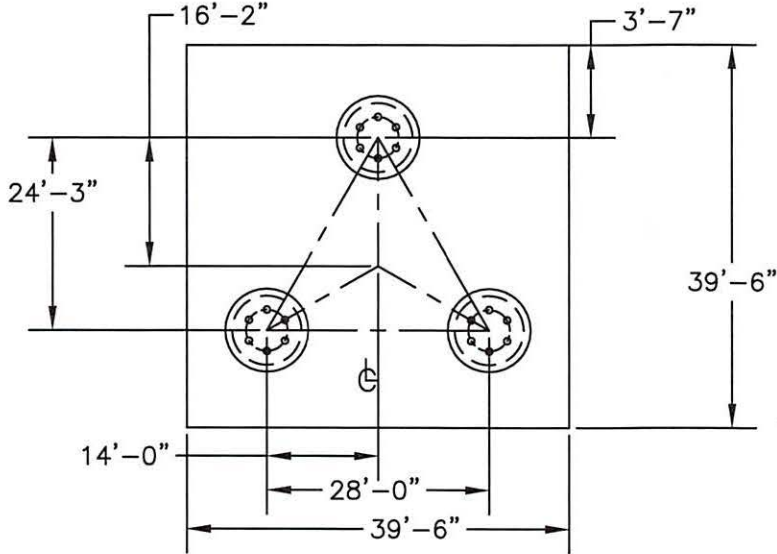

GENERAL NOTES

1. CONCRETE TO HAVE 4500 PSI MIN. COMPRESSIVE STRENGTH AFTER 28 DAYS.
2. ALL REINFORCEMENT STEEL IS DEFORMED AND MEETS THE STRENGTH REQUIREMENTS OF ASTM A615 GRADE 60.
3. EMBEDDED STEEL TO HAVE 3" MIN. CONCRETE COVER.
4. FOUNDATION DESIGN IS BASED ON CUSTOMER SUPPLIED SOIL DATA FROM EAST KENTUCKY ENGINEERING, LLC. PROJECT NUMBER 165-000-0100 DATED MARCH 4, 2020.

03/25/2020



TITLE: FOUNDATION DETAIL
300' WSST TOWER
FOR: EAST KENTUCKY NETWORK
SITE: HICKORY GROVE
MORGAN COUNTY, KY

WORLD TOWER

SCALE NONE	OWN.	LKG	CKD.	DATE 3-34-20
FILE	DWG. NO.			Q200220F

6



Mail Processing Center
 Federal Aviation Administration
 Southwest Regional Office
 Obstruction Evaluation Group
 10101 Hillwood Parkway
 Fort Worth, TX 76177

Aeronautical Study No.
 2019-ASO-35376-OE

Issued Date: 01/08/2020

Cindy D. McCarty
 East Kentucky Network, LLC
 101 Technology Trail
 Ivel, KY 41642

**** DETERMINATION OF NO HAZARD TO AIR NAVIGATION ****

The Federal Aviation Administration has conducted an aeronautical study under the provisions of 49 U.S.C., Section 44718 and if applicable Title 14 of the Code of Federal Regulations, part 77, concerning:

Structure: Antenna Tower Hickory Grove
 Location: West Liberty, KY
 Latitude: 38-01-18.70N NAD 83
 Longitude: 83-21-48.50W
 Heights: 1149 feet site elevation (SE)
 310 feet above ground level (AGL)
 1459 feet above mean sea level (AMSL)

This aeronautical study revealed that the structure does not exceed obstruction standards and would not be a hazard to air navigation provided the following condition(s), if any, is(are) met:

As a condition to this Determination, the structure is to be marked/lighted in accordance with FAA Advisory circular 70/7460-1 L Change 2, Obstruction Marking and Lighting, 24-hr med-strobes - Chapters 4,6(MIWOL),&12.

Any failure or malfunction that lasts more than thirty (30) minutes and affects a top light or flashing obstruction light, regardless of its position, should be reported immediately to (877) 487-6867 so a Notice to Airmen (NOTAM) can be issued. As soon as the normal operation is restored, notify the same number.

It is required that FAA Form 7460-2, Notice of Actual Construction or Alteration, be e-filed any time the project is abandoned or:

- At least 10 days prior to start of construction (7460-2, Part 1)
- Within 5 days after the construction reaches its greatest height (7460-2, Part 2)

The use of a 24-hour medium intensity flashing white light system in urban and rural areas often results in complaints.

This determination expires on 07/08/2021 unless:

- (a) the construction is started (not necessarily completed) and FAA Form 7460-2, Notice of Actual Construction or Alteration, is received by this office.
- (b) extended, revised, or terminated by the issuing office.
- (c) the construction is subject to the licensing authority of the Federal Communications Commission (FCC) and an application for a construction permit has been filed, as required by the FCC, within 6 months of the date of this determination. In such case, the determination expires on the date prescribed by the FCC for completion of construction, or the date the FCC denies the application.

NOTE: REQUEST FOR EXTENSION OF THE EFFECTIVE PERIOD OF THIS DETERMINATION MUST BE E-FILED AT LEAST 15 DAYS PRIOR TO THE EXPIRATION DATE. AFTER RE-EVALUATION OF CURRENT OPERATIONS IN THE AREA OF THE STRUCTURE TO DETERMINE THAT NO SIGNIFICANT AERONAUTICAL CHANGES HAVE OCCURRED, YOUR DETERMINATION MAY BE ELIGIBLE FOR ONE EXTENSION OF THE EFFECTIVE PERIOD.

This determination is based, in part, on the foregoing description which includes specific coordinates, heights, frequency(ies) and power. Any changes in coordinates, heights, and frequencies or use of greater power, except those frequencies specified in the Colo Void Clause Coalition; Antenna System Co-Location; Voluntary Best Practices, effective 21 Nov 2007, will void this determination. Any future construction or alteration, including increase to heights, power, or the addition of other transmitters, requires separate notice to the FAA. This determination includes all previously filed frequencies and power for this structure.

If construction or alteration is dismantled or destroyed, you must submit notice to the FAA within 5 days after the construction or alteration is dismantled or destroyed.

This determination does include temporary construction equipment such as cranes, derricks, etc., which may be used during actual construction of the structure. However, this equipment shall not exceed the overall heights as indicated above. Equipment which has a height greater than the studied structure requires separate notice to the FAA.

This determination concerns the effect of this structure on the safe and efficient use of navigable airspace by aircraft and does not relieve the sponsor of compliance responsibilities relating to any law, ordinance, or regulation of any Federal, State, or local government body.

A copy of this determination will be forwarded to the Federal Communications Commission (FCC) because the structure is subject to their licensing authority.

If we can be of further assistance, please contact our office at (718) 553-2611, or angelique.eersteling@faa.gov. On any future correspondence concerning this matter, please refer to Aeronautical Study Number 2019-ASO-35376-OE.

Signature Control No: 423858818-427244804

(DNE)

Angelique Eersteling
Technician

Attachment(s)
Frequency Data
Map(s)

cc: FCC

Frequency Data for ASN 2019-ASO-35376-OE

LOW FREQUENCY	HIGH FREQUENCY	FREQUENCY UNIT	ERP	ERP UNIT
6	7	GHz	55	dBW
6	7	GHz	42	dBW
10	11.7	GHz	55	dBW
10	11.7	GHz	42	dBW
17.7	19.7	GHz	55	dBW
17.7	19.7	GHz	42	dBW
21.2	23.6	GHz	55	dBW
21.2	23.6	GHz	42	dBW
614	698	MHz	1000	W
614	698	MHz	2000	W
698	806	MHz	1000	W
806	901	MHz	500	W
806	824	MHz	500	W
824	849	MHz	500	W
851	866	MHz	500	W
869	894	MHz	500	W
896	901	MHz	500	W
901	902	MHz	7	W
929	932	MHz	3500	W
930	931	MHz	3500	W
931	932	MHz	3500	W
932	932.5	MHz	17	dBW
935	940	MHz	1000	W
940	941	MHz	3500	W
1670	1675	MHz	500	W
1710	1755	MHz	500	W
1850	1910	MHz	1640	W
1850	1990	MHz	1640	W
1930	1990	MHz	1640	W
1990	2025	MHz	500	W
2110	2200	MHz	500	W
2305	2360	MHz	2000	W
2305	2310	MHz	2000	W
2345	2360	MHz	2000	W
2496	2690	MHz	500	W

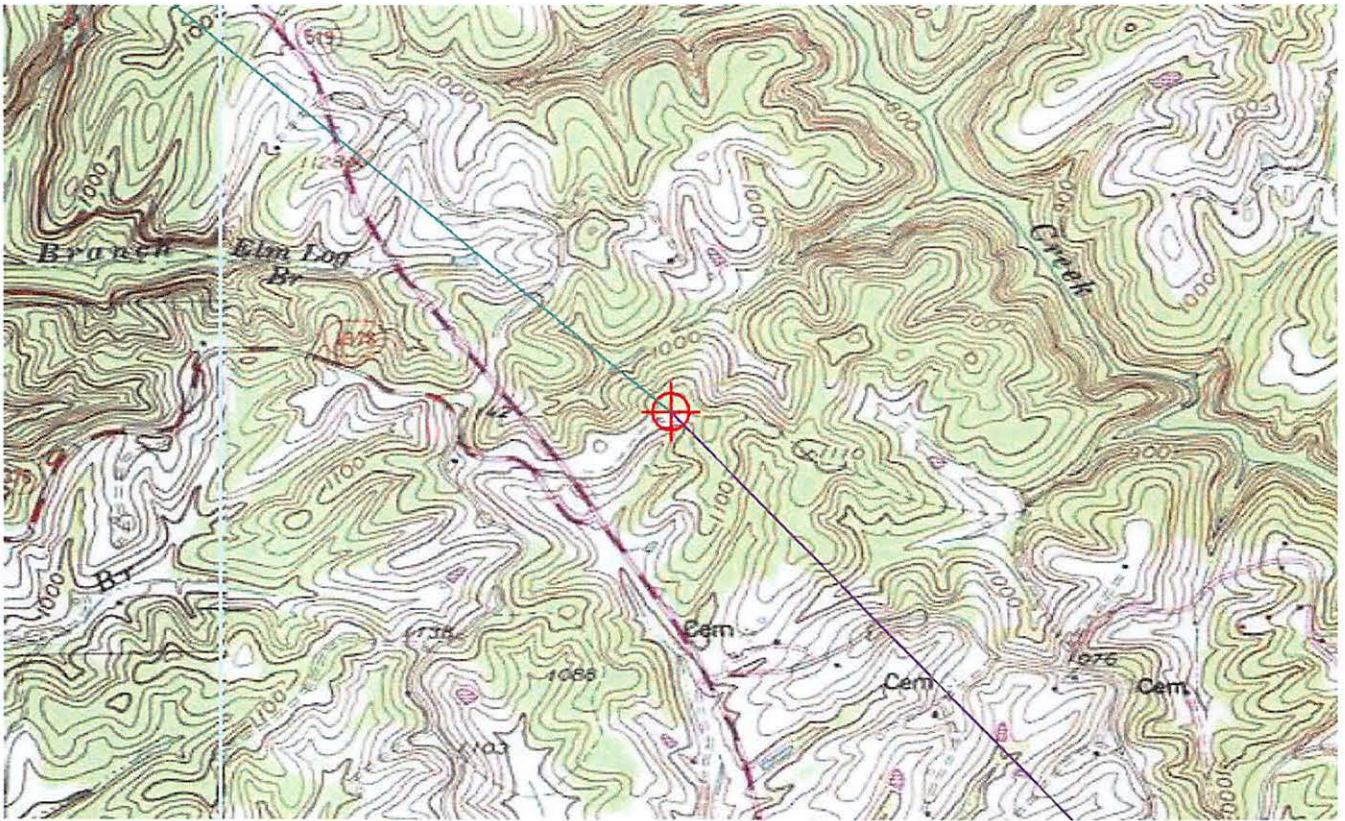

TOPO Map for ASN 2019-ASO-35376-OE





KENTUCKY AIRPORT ZONING COMMISSION

Andy Beshear
Governor

421 Buttermilk Pike
Covington, KY 41017
www.transportation.ky.gov
859-341-2700

March 5, 2020

APPROVAL OF APPLICATION

APPLICANT:

East KY Network LLC (Ivel KY)
East KY Network LLC (Ivel KY)
101 Technology Trail
Ivel, KY 41642

SUBJECT: AS-088-913-2020-001

STRUCTURE: Antenna Tower
LOCATION: West Liberty, KY
COORDINATES: 38° 1' 18.7" N / 83° 21' 48.5" W
HEIGHT: 310' AGL/1459' AMSL

The Kentucky Airport Zoning Commission has approved your application for a permit to construct 310' AGL/ 1459' AMSL Antenna Tower near West Liberty, KY 38° 1' 18.7" N / 83° 21' 48.5" W.

This permit is valid for a period of 18 Month(s) from its date of issuance. If construction is not completed within said 18-Month period, this permit shall lapse and be void, and no work shall be performed without the issuance of a new permit.

Medium Intensity White Obstruction Lighting is required.

A handwritten signature in cursive script that reads "John Houlihan".

John Houlihan
Administrator



An Equal Opportunity Employer M/F/D

7

Driving Directions for Hickory Grove

1. Beginning at 261 Court Street, West Liberty, KY, head west on Prestonsburg Street toward Bailey Lane and travel approximately 0.2 miles.
2. Turn right onto KY-7 N/Main Street and drive approximately 2.7 miles.
3. Continue straight onto KY-519 N for 7.2 miles.
4. Turn right at a private driveway and drive .2 miles.
5. Site access road will be on the left. Walk approximately six hundred feet to the site (sign will be posted)

Prepared By:
Daryl Bartley
Appalachian Wireless
(606) 791-0310

Hickory Grove

Location:

7604 Highway 519
West Liberty, KY 41472

Coordinates:

38°01'18.6994"N
83°21'48.5483"W

Legend

 1/2 Mile Search Area

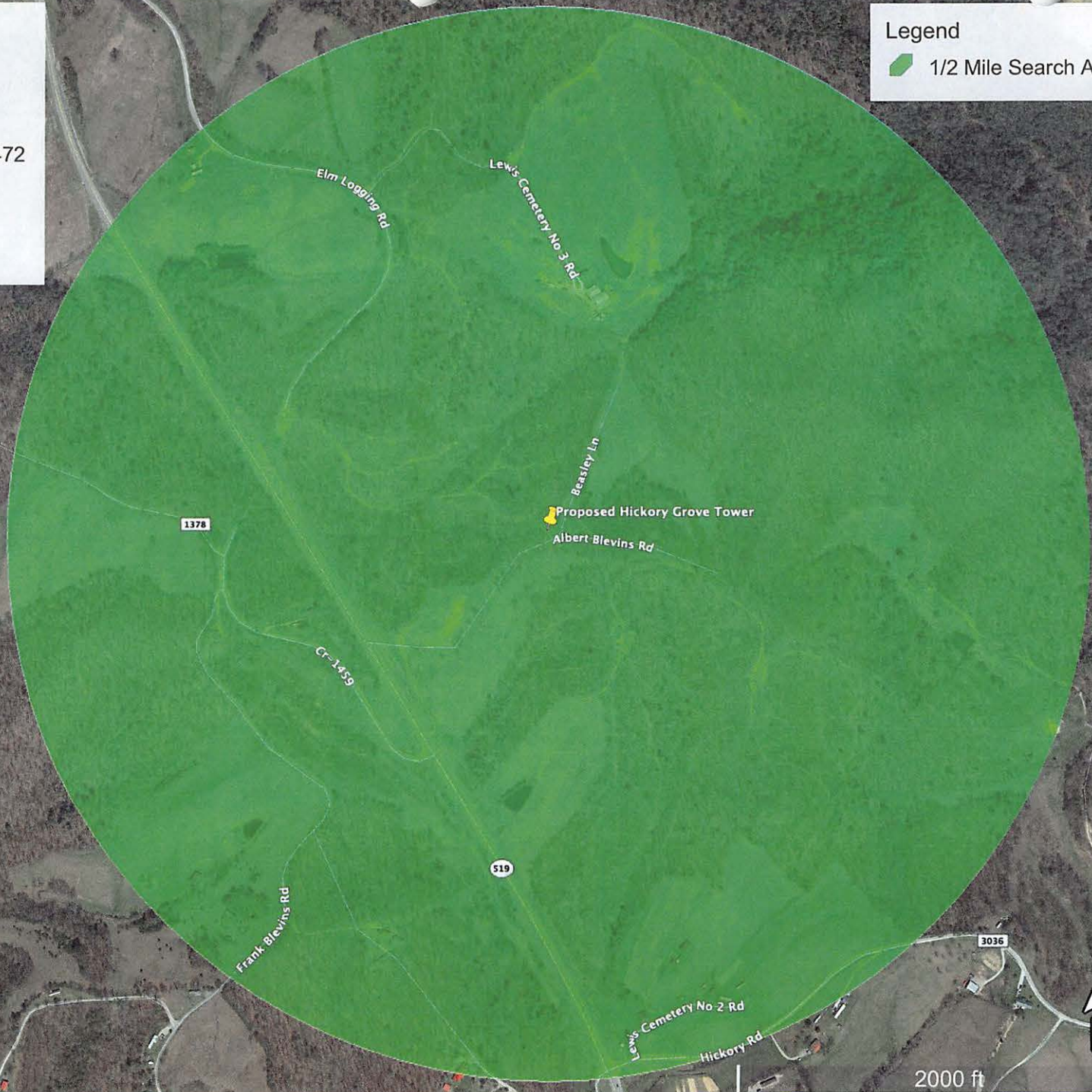

Google Earth

© 2020 Google

2000 ft

8

NOV 15 2019

TIME: 3:30 PM
RANDY WILLIAMS CLERK

26 pgs.

MEMORANDUM OF LEASE

THIS MEMORANDUM OF LEASE is made and entered into on this 15th day of November, 2019, with a commencement date of November 1, 2019 (the "Commencement Date"), by and between **CLAYTON JOHNSON** and **TERETHA JOHNSON**, a married couple, with an address of 7600 Hwy 519, West Liberty, Kentucky 41472, hereinafter referred to as "Lessors", and **EAST KENTUCKY NETWORK, LLC D/B/A APPALACHIAN WIRELESS**, a Kentucky limited liability company, with a mailing address of 101 Technology Trail, Ivel, Kentucky, 41642, hereinafter referred to as "Lessee."

Manj →

WITNESSETH

1. **Demised Premises.** For good and valuable consideration, Lessors leased to Lessee, and Lessee has leased from Lessors that certain tract of real estate located in Morgan County, Kentucky, and being a portion of the same land conveyed to Lessors by Deed dated September 19, 2017, and recorded on October 3, 2017, in Deed Book 236, Page 601, in the Morgan County Clerk's Office. Said property is more particularly described in the description **attached** hereto and made a part hereof as **Exhibit A** and the plat **attached** hereto and made a part hereof as **Exhibit B**, prepared by James W. Caudill, Licensed Professional Land Surveyor (hereinafter referred to as the "Premises"). The Lessors have also granted unto Lessee full and complete rights of ingress, egress and regress to and from the Premises over any property owned by Lessors and other associated rights for installation of utilities, maintenance, and other purposes. Lessee has the absolute right to assign, sublease, sublicense or otherwise transfer, in whole or in part, the Leased Premises and the easements and rights-of-way.

2. **Term.** The initial term of the Lease is for a period of five (5) years from the Commencement Date set forth above.

Attn: Compliance Dept.

3. **Renewals.** The Lease shall automatically renew for an additional seven (7) terms of five (5) years each, unless Lessee provides sixty (60) days written notice prior to the end of the current term that it does not wish to renew.

4. **Binding Effect.** All of the terms, conditions, and covenants hereof shall be binding and inure to the benefit of the parties and their respective heirs, representatives, successors, and assigns.

5. **Purpose.** This Memorandum of Lease is prepared solely for the purpose of recordation, and is not intended to, nor shall it be deemed to, modify any of the terms and conditions set forth in the Lease, nor to construe any of the rights, duties or responsibilities of Lessors and Lessee. In the event of any conflict between the terms and conditions of this Memorandum and the terms and conditions of the Lease, the terms and conditions of the Lease shall supersede and control.

[THE REMAINDER OF THIS PAGE INTENTIONALLY LEFT BLANK.]

IN WITNESS WHEREOF, Lessors and Lessee have caused their names to be signed hereto, as of the date(s) indicated below.

LESSORS:

Clay Johnson
CLAYTON JOHNSON

Teretha Johnson
TERETHA JOHNSON

COMMONWEALTH OF KENTUCKY
COUNTY OF Morgan

The foregoing instrument was acknowledged before me on this 15th day of November, 2019, by Clayton Johnson and Teretha Johnson, Lessors.

Raina D. Helton
Notary Public

My Commission Expires 2-6-2020



LESSEE:

EAST KENTUCKY NETWORK, LLC D/B/A
APPALACHIAN WIRELESS

W A Gillum

By: W.A. Gillum
Its: CEO/ General Manager

COMMONWEALTH OF KENTUCKY
COUNTY OF Floyd

The foregoing instrument was acknowledged before me on this 13th day of November, 2019, by W.A. Gillum, CEO/General Manager of East Kentucky Network, LLC d/b/a Appalachian Wireless, Lessee.

Raina D. Helton
Notary Public

My Commission Expires 2-6-2020



This instrument was prepared by:

Krystal Branham

Krystal Branham, Attorney

101 Technology Trail

Ivel, Kentucky 41642

(606) 477-2355

LOT DESCRIPTION

Property of
Clayton Johnson and Teretha Brooke Johnson
444 Bluestone Road
Morehead, KY 40351
Off Highway 519 Near Hickory Grove
in Morgan County, KY
February 11, 2019

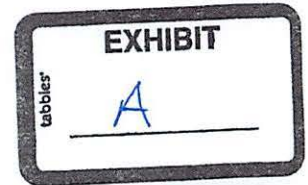

A certain tract or parcel of land lying and being in Morgan County, Kentucky, and being a portion of the property conveyed to Clayton Johnson, and wife, Teretha Brooke Johnson from Daniel Ferguson, and wife, Sharina Ferguson, by deed of conveyance dated September 19, 2017 and of record in Deed Book 236, Page 601, records of Morgan County Court Clerk's Office. Said property being more particularly described as follows:

Lot 1A

Beginning at a found iron pin with cap marked LS#2768 at a fence post, a corner to a wire fence, and being on the dividing property line between Clayton and Teretha Brooke Johnson (Deed Book 236 Page 601), and Denny Beasley (Deed Book 230 Page 769); thence continuing with said property line and fence South 69 deg 56 min 25 sec East, a distance of 25.34 feet to a set iron pin with cap marked LS#2259 near fence; thence South 10 deg 49 min 38 sec West, a distance of 70.05 feet, leaving said property line and severing the property of Clayton and Teretha Brooke Johnson (Deed Book 236 Page 601) to a set iron pin with cap marked LS#2259 on the hillside; thence around the hillside South 82 deg 07 min 42 sec West, a distance of 122.09 feet, to a set iron pin with cap marked LS#2259 on hillside; thence continuing around hillside North 30 deg 40 min 55 sec West, a distance of 52.59 feet, to a set iron pin with cap marked LS#2259 on hillside; thence still with hillside North 11 deg 09 min 29 sec East, a distance of 149.89 feet, to a set iron pin with cap marked LS#2259 on hillside; thence up the hill South 78 deg 55 min 20 sec East, a distance of 128.76 feet, to a set iron pin with cap on the ridge and the dividing property line of Johnson (Deed Book 236 Page 601) and Beasley (Deed Book 230 Page 769); thence continuing with said ridge and property line South 08 deg 38 min 10 sec West, a distance of 59.88 feet, to a found iron pin with cap at fence; thence continuing with said ridge and property line South 33 deg 12 min 38 sec West, a distance of 16.88 feet to the point of beginning. Containing a calculated area of 23,850.1 square feet or 0.55 acres.

Also to be included is a right of way along the existing access road from Highway 519 to the residence of Clayton and Teretha Brooke Johnson, along with a 50 foot right of way to construct a new section of access road from the existing access road to Lot 1A, so as to complete an access route from Highway 519 to Lot 1A. Also to be included is a right to install fiber and utility lines in or along said access road and/or such other location to be agreed upon by the parties.

Unless stated otherwise, any monument referred to herein as "set iron pin with cap" is a set 1/2" diameter rebar, at least eighteen (18") in length, with a plastic cap stamped "LS-2259". All bearings stated herein are referred to NAD83, KY single zone of the Kentucky state plane system.

This survey was performed on February 11, 2019 by James W. Caudill, a Kentucky Licensed Professional Land Surveyor No. 2259.



James W. Caudill
James W. Caudill, PLS #2259
11-10-19

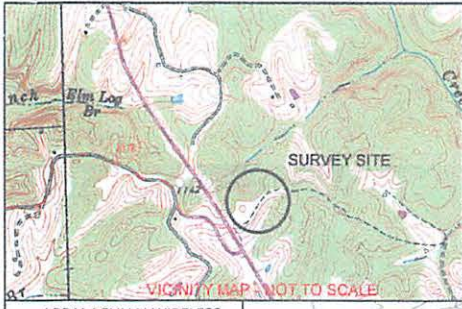

APPALACHIAN WIRELESS
101 TECHNOLOGY TRAIL
IVEL, KY. 41642
PROPOSED TOWER SITE
OFF HWY 519 NEAR HICKORY GROVE
IN MORGAN COUNTY, KY.

EXHIBIT
tabbies
B

Beginning at a found iron pin with cap at fence corner ;
thence S 69°56'25" E a distance of 25.34' to a set ipc rt of fence;
thence S 10°49'38" W a distance of 70.05' to a set ipc on hillside;
thence S 82°07'42" W a distance of 122.09' to a set ipc on hillside;
thence N 30°40'55" W a distance of 52.59' to a set ipc on hillside;
thence N 11°09'29" E a distance of 149.89' to a set ipc on hillside;
thence S 78°55'20" E a distance of 128.76' to a set ipc on ridge;
thence S 08°38'10" W a distance of 59.88' to a found ipc on ridge;
thence S 33°12'38" W a distance of 16.88' to a found ipc on ridge;
which is the point of beginning,
having an area of 23850.1 square feet, 0.55 acres

CLAYTON AND
TERETHA BROOKE JOHNSON
DEED BOOK 236 PAGE 601

DENNY BEASLEY
DEED BOOK 230 PAGE 769

CLAYTON AND
TERETHA BROOKE JOHNSON
DEED BOOK 236 PAGE 601

JEFFREY AND
TEENA SPENCER
DEED BOOK 239 PAGE 163

CLAYTON AND
TERETHA BROOKE JOHNSON
DEED BOOK 236 PAGE 601

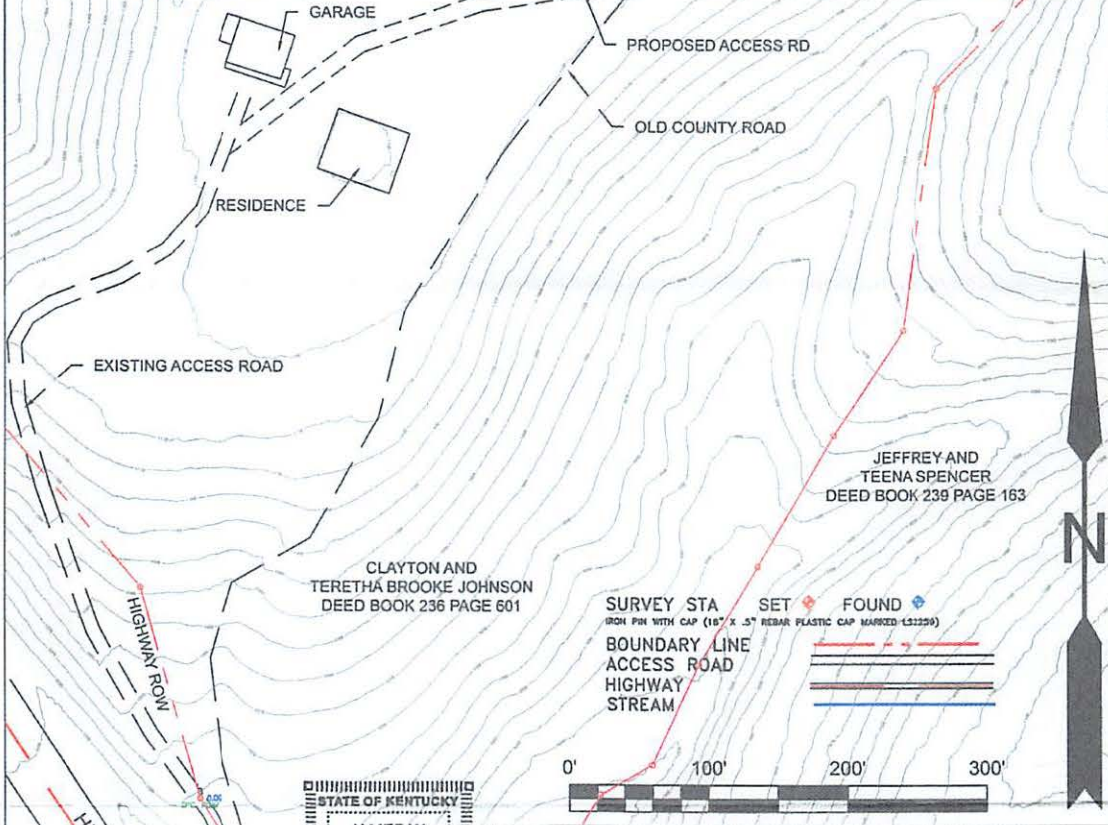

SURVEY STA SET \blacklozenge FOUND \blacklozenge
IRON PIN WITH CAP (1/8" x .5" REBAR PLASTIC CAP MARKED LS2259)
BOUNDARY LINE
ACCESS ROAD
HIGHWAY
STREAM

STATE OF KENTUCKY
JAMES W. CAUDILL
2259
LICENSED PROFESSIONAL LAND SURVEYOR

PLAT OF SURVEY

DRAWN JWC	DATE 02/11/19	SUBDIVISION OF THE PROPERTY OF CLAYTON JOHNSON & TERETHA BROOKE JOHNSON HICKORY GROVE, MORGAN CO DEED BOOK 236 PAGE 601
APPROVED	DATE 04/10/19	
SCALE 1" = 100'	SHEET 1 OF 1	SURVEYED BY JAMES W. CAUDILL LS2259 2999 PERKINS/MADDEN ROAD AMBURGEY, KY 41773 PHONE 606-642-3217

URBAN CLASS SURVEY
I HEREBY CERTIFY THAT THIS PLAT DEPICTS A SURVEY, MADE
BY ME, BY THE METHOD OF RANDOM TRAVERSE. THE
BEARINGS SHOWN HEREON HAVE NOT BEEN ADJUSTED FOR
CLOSURE. THIS SURVEY AND PLAT MEETS OR EXCEEDS
THE MINIMUM STANDARDS OF GOVERNING AUTHORITIES.
THE UNADJUSTED ERROR OF CLOSURE WAS > 1 IN 10000.
James W. Caudill
NAME PLS# 2259 DATE 4/10/19

STATE OF KENTUCKY
COUNTY OF MORGAN

I, Randy Williams, Clerk Morgan County for the county and state
do hereby certify that the foregoing was was on the
15th day of Nov, 2019 lodged for record, whereupon
the foregoing and this Certificate have been duly recorded in my office.
Given under my hand this the 15th day of Nov 2019.

Randy Williams, Clerk
[Signature] D.C.

LB 101 page 65

9

APPALACHIAN WIRELESS
101 TECHNOLOGY TRAIL
IVEL, KY 41642
PROPOSED TOWER SITE
NEAR HICKORY GROVE
IN MORGAN COUNTY, KY

MAP 37 PARCEL 17.04
CLAYTON AND TEREHA BROOKE JOHNSON
444 BLUESTONE ROAD
MOREHEAD, KY 40351
DEED BOOK 236 PAGE 601

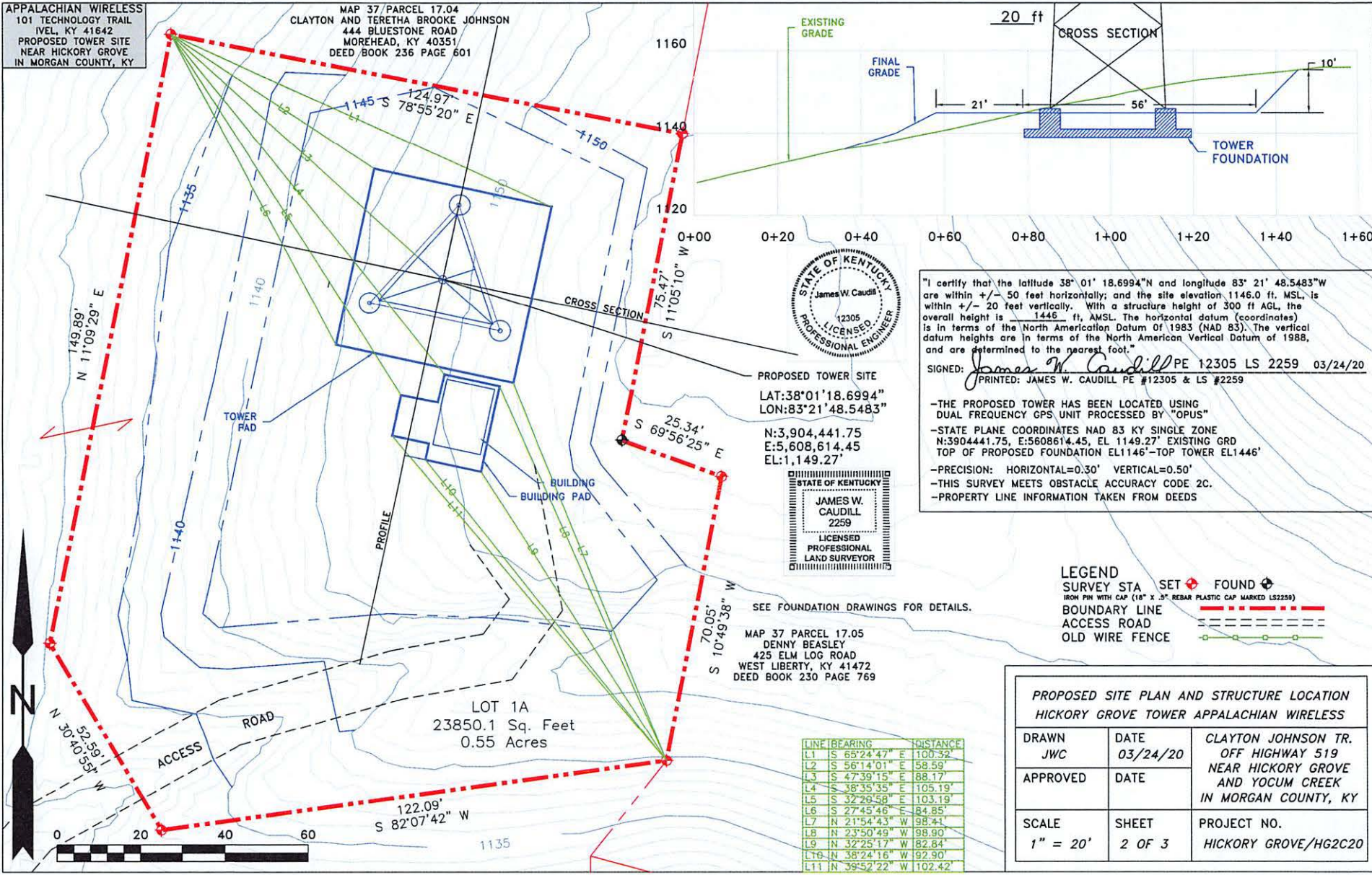

PROPOSED TOWER SITE
LAT: 38°01'18.6994"
LON: 83°21'48.5483"

N: 3,904,441.75
E: 5,608,614.45
EL: 1,149.27'



SEE FOUNDATION DRAWINGS FOR DETAILS.

MAP 37 PARCEL 17.05
DENNY BEASLEY
425 ELM LOG ROAD
WEST LIBERTY, KY 41472
DEED BOOK 230 PAGE 769

LOT 1A
23850.1 Sq. Feet
0.55 Acres

LINE	BEARING	DISTANCE
L1	S 65°24'47" E	100.32'
L2	S 56°14'01" E	58.59'
L3	S 47°39'15" E	88.17'
L4	S 38°35'35" E	105.19'
L5	S 32°29'58" E	103.19'
L6	S 27°45'46" E	84.85'
L7	N 21°54'43" W	98.41'
L8	N 23°50'49" W	98.90'
L9	N 32°25'17" W	82.84'
L10	N 38°24'16" W	92.90'
L11	N 39°52'22" W	102.42'

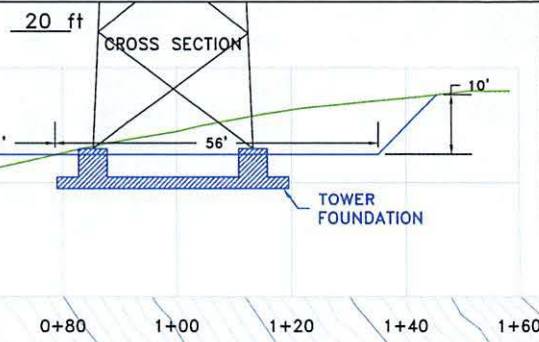

"I certify that the latitude 38° 01' 18.6994"N and longitude 83° 21' 48.5483"W are within +/- 50 feet horizontally; and the site elevation 1146.0 ft. MSL, is within +/- 20 feet vertically. With a structure height of 300 ft AGL, the overall height is 1446 ft, AMSL. The horizontal datum (coordinates) is in terms of the North American Datum of 1983 (NAD 83). The vertical datum heights are in terms of the North American Vertical Datum of 1988, and are determined to the nearest foot."

SIGNED: *James W. Caudill* PE 12305 LS 2259 03/24/20
PRINTED: JAMES W. CAUDILL PE #12305 & LS #2259

- THE PROPOSED TOWER HAS BEEN LOCATED USING DUAL FREQUENCY GPS UNIT PROCESSED BY "OPUS"
- STATE PLANE COORDINATES NAD 83 KY SINGLE ZONE N:3904441.75, E:5608614.45, EL 1149.27' EXISTING GRD TOP OF PROPOSED FOUNDATION EL1146'-TOP TOWER EL1446'
- PRECISION: HORIZONTAL=0.30' VERTICAL=0.50'
- THIS SURVEY MEETS OBSTACLE ACCURACY CODE 2C.
- PROPERTY LINE INFORMATION TAKEN FROM DEEDS

- LEGEND
- SURVEY STA SET + FOUND +
 - IRON PIN WITH CAP (1/8" X 3/8" REBAR PLASTIC CAP MARKED LS2259)
 - BOUNDARY LINE
 - ACCESS ROAD
 - OLD WIRE FENCE

PROPOSED SITE PLAN AND STRUCTURE LOCATION HICKORY GROVE TOWER APPALACHIAN WIRELESS		
DRAWN JWC	DATE 03/24/20	CLAYTON JOHNSON TR. OFF HIGHWAY 519 NEAR HICKORY GROVE AND YOCUM CREEK IN MORGAN COUNTY, KY
APPROVED	DATE	
SCALE 1" = 20'	SHEET 2 OF 3	PROJECT NO. HICKORY GROVE/HG2C20

10

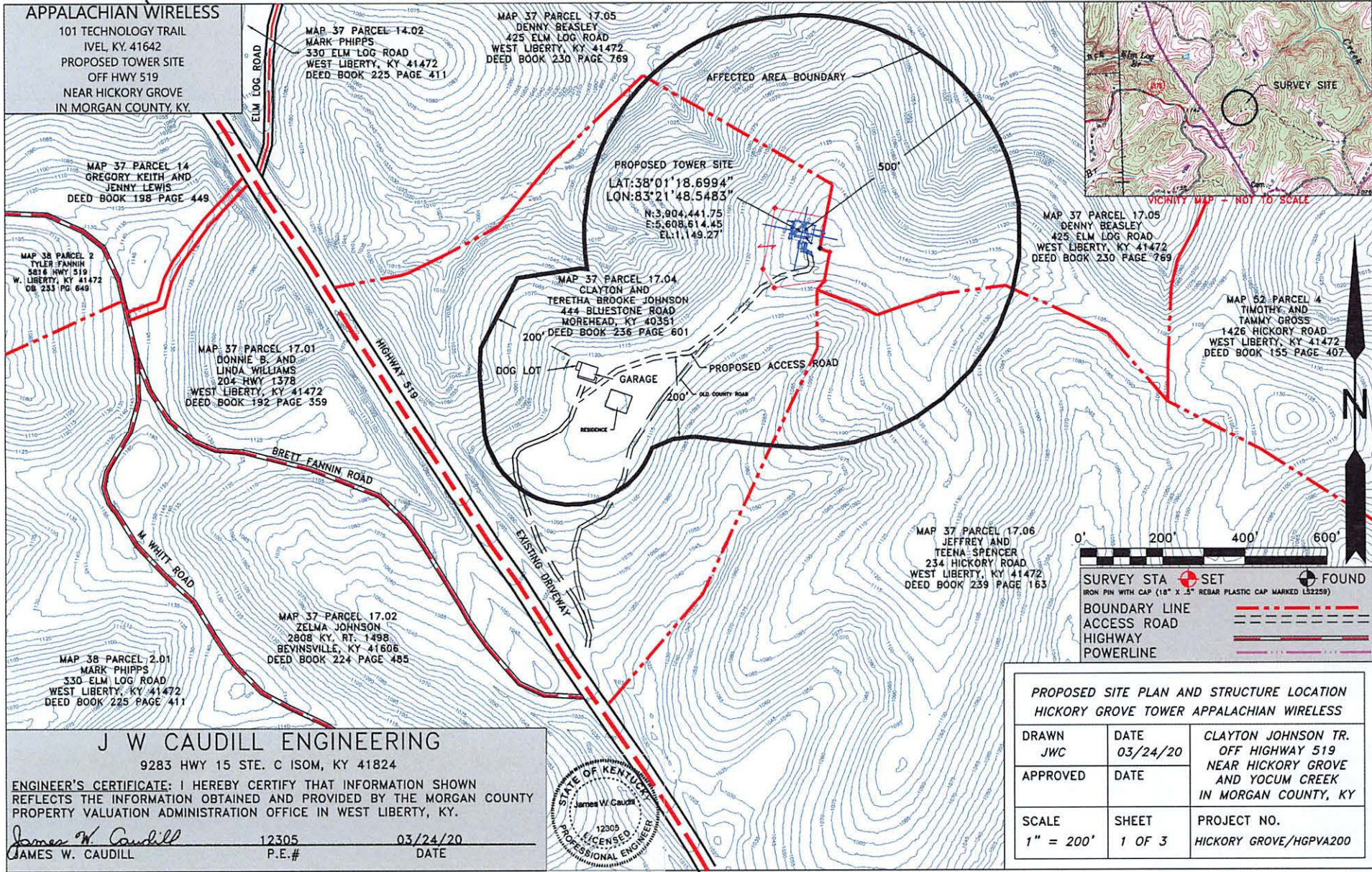

APPALACHIAN WIRELESS

101 TECHNOLOGY TRAIL
IVEL, KY. 41642
PROPOSED TOWER SITE
OFF HWY 519
NEAR HICKORY GROVE
IN MORGAN COUNTY, KY.

MAP 37 PARCEL 14.02
MARK PHIPPS
330 ELM LOG ROAD
WEST LIBERTY, KY 41472
DEED BOOK 225 PAGE 411

MAP 37 PARCEL 17.05
DENNY BEASLEY
425 ELM LOG ROAD
WEST LIBERTY, KY 41472
DEED BOOK 230 PAGE 769

MAP 37 PARCEL 14
GREGORY KEITH AND
JENNY LEWIS
DEED BOOK 198 PAGE 449

PROPOSED TOWER SITE
LAT: 38°01'18.6994"
LON: 83°21'48.5483"
N: 3,904,441.75
E: 5,608,614.45
EL: 1,149.27'

MAP 37 PARCEL 17.05
DENNY BEASLEY
425 ELM LOG ROAD
WEST LIBERTY, KY 41472
DEED BOOK 230 PAGE 769

MAP 38 PARCEL 2
TYLER FANNIN
5816 HWY 519
W. LIBERTY, KY 41472
DB 233 PG 649

MAP 37 PARCEL 17.01
DONNIE B. AND
LINDA WILLIAMS
204 HWY 1378
WEST LIBERTY, KY 41472
DEED BOOK 192 PAGE 359

MAP 37 PARCEL 17.04
CLAYTON AND
TERETHA BROOKE JOHNSON
444 BLUESTONE ROAD
MOREHEAD, KY 40351
200' DEED BOOK 236 PAGE 601

MAP 52 PARCEL 4
TIMOTHY AND
TAMMY GROSS
1426 HICKORY ROAD
WEST LIBERTY, KY 41472
DEED BOOK 155 PAGE 407

MAP 37 PARCEL 17.06
JEFFREY AND
TEENA SPENCER
234 HICKORY ROAD
WEST LIBERTY, KY 41472
DEED BOOK 239 PAGE 163

MAP 37 PARCEL 17.02
ZELMA JOHNSON
2808 KY. RT. 1498
BEVINSVILLE, KY 41606
DEED BOOK 224 PAGE 485

MAP 38 PARCEL 2.01
MARK PHIPPS
330 ELM LOG ROAD
WEST LIBERTY, KY 41472
DEED BOOK 225 PAGE 411

J W CAUDILL ENGINEERING

9283 HWY 15 STE. C ISOM, KY 41824

ENGINEER'S CERTIFICATE: I HEREBY CERTIFY THAT INFORMATION SHOWN REFLECTS THE INFORMATION OBTAINED AND PROVIDED BY THE MORGAN COUNTY PROPERTY VALUATION ADMINISTRATION OFFICE IN WEST LIBERTY, KY.

James W. Caudill 12305 03/24/20
JAMES W. CAUDILL P.E.# DATE



**PROPOSED SITE PLAN AND STRUCTURE LOCATION
HICKORY GROVE TOWER APPALACHIAN WIRELESS**

DRAWN JWC	DATE 03/24/20	CLAYTON JOHNSON TR. OFF HIGHWAY 519 NEAR HICKORY GROVE AND YOCUM CREEK IN MORGAN COUNTY, KY
APPROVED	DATE	
SCALE 1" = 200'	SHEET 1 OF 3	PROJECT NO. HICKORY GROVE/HGPVA200

11

APPALACHIAN WIRELESS
 101 TECHNOLOGY TRAIL
 IVEL, KY 41642
 PROPOSED TOWER SITE
 NEAR HICKORY GROVE
 IN MORGAN COUNTY, KY

PROPOSED SITE PLAN AND STRUCTURE LOCATION HICKORY GROVE TOWER APPALACHIAN WIRELESS		
DRAWN JWC	DATE 03/24/20	CLAYTON JOHNSON TR. OFF HIGHWAY 519 NEAR HICKORY GROVE AND YOCUM CREEK IN MORGAN COUNTY, KY
APPROVED	DATE	
SCALE 1" = 20'	SHEET 3 OF 3	PROJECT NO. HICKORY GROVE/HGPRO20

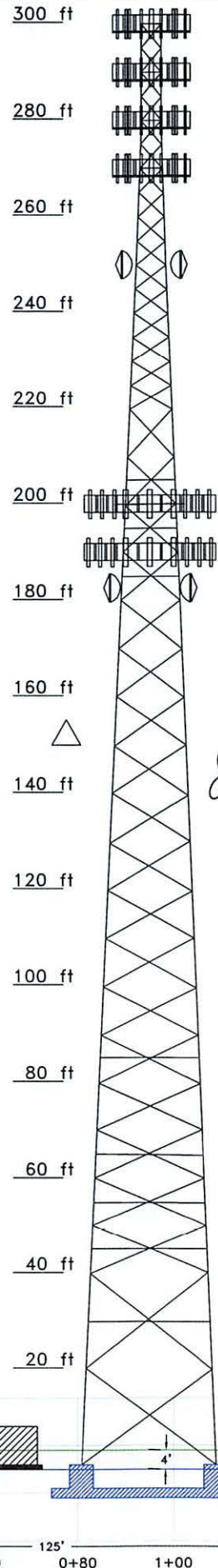

PROFILE WITH TOWER

THIS IS A VERTICAL PROFILE SKETCH OF THE TOWER INDICATING THE PROPOSED ANTENNA AND DISH ELEVATIONS. NO DESIGN CRITERIA WAS CONSIDERED IN THE PREPARATION OF THIS DRAWING.

James W. Caudill 12305 03/24/20
 JAMES W. CAUDILL PE #. DATE

NOTE: SEE FOUNDATION DRAWINGS FOR DETAILS

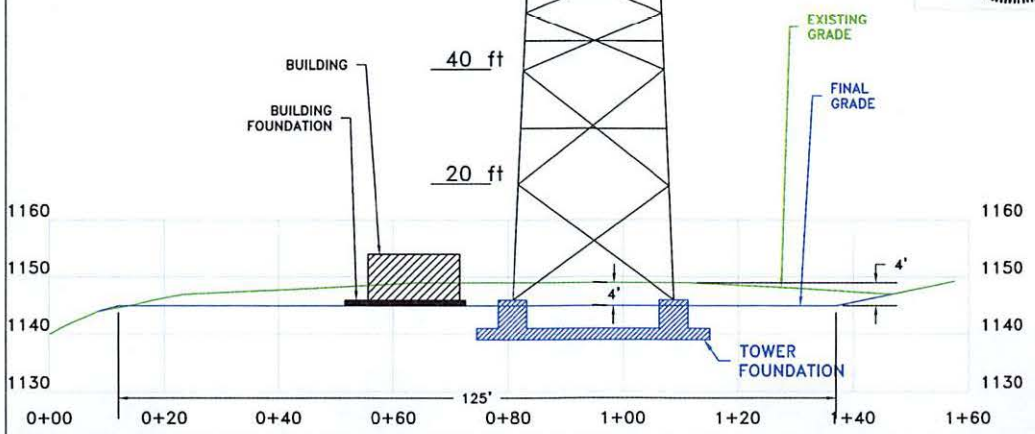
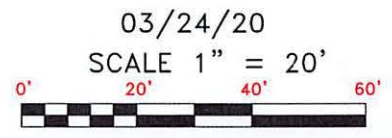

12

Utility ID	Utility Name	Utility Type	Class	City	State
4107900	365 Wireless, LLC	Cellular	D	Atlanta	GA
4109300	Access Point, Inc.	Cellular	D	Cary	NC
4108300	Air Voice Wireless, LLC	Cellular	A	Bloomfield Hill	MI
4110650	Alliant Technologies of KY, L.L.C.	Cellular	C	Morristown	NJ
44451184	Alltel Communications, LLC	Cellular	A	Basking Ridge	NJ
4110850	AltaWorx, LLC	Cellular	C	Fairhope	AL
4107800	American Broadband and Telecommunications Company	Cellular	C	Toledo	OH
4108650	AmeriMex Communications Corp.	Cellular	D	Dunedin	FL
4105100	AmeriVision Communications, Inc. d/b/a Affinity 4	Cellular	D	Virginia Beach	VA
4110700	Andrew David Balholm dba Norcell	Cellular	C	Clayton	WA
4108600	BCN Telecom, Inc.	Cellular	D	Morristown	NJ
4110550	Blue Casa Mobile, LLC	Cellular	D	Santa Barbara	CA
4108750	Blue Jay Wireless, LLC	Cellular	C	Carrollton	TX
4111050	BlueBird Communications, LLC	Cellular	C	New York	NY
4202300	Bluegrass Wireless, LLC	Cellular	A	Elizabethtown	KY
4107600	Boomerang Wireless, LLC	Cellular	B	Hiawatha	IA
4105500	BullsEye Telecom, Inc.	Cellular	D	Southfield	MI
4110050	CampusSims, Inc.	Cellular	D	Boston	MA
4100700	Cellco Partnership dba Verizon Wireless	Cellular	A	Basking Ridge	NJ
4106600	Cintex Wireless, LLC	Cellular	D	Rockville	MD
4111000	ComApp Technologies LLC	Cellular	C	Melrose	MA
4101900	Consumer Cellular, Incorporated	Cellular	A	Portland	OR
4106400	Credo Mobile, Inc.	Cellular	A	San Francisco	CA
4108850	Cricket Wireless, LLC	Cellular	A	San Antonio	TX
4001900	CTC Communications Corp. d/b/a EarthLink Business I	Cellular	D	Grand Rapids	MI
10640	Cumberland Cellular Partnership	Cellular	A	Elizabethtown	KY
4101000	East Kentucky Network, LLC dba Appalachian Wireless	Cellular	A	Ivel	KY
4002300	Easy Telephone Service Company dba Easy Wireless	Cellular	D	Ocala	FL
4109500	Enhanced Communications Group, LLC	Cellular	D	Bartlesville	OK
4110450	Excellus Communications, LLC	Cellular	D	Chattanooga	TN
4105900	Flash Wireless, LLC	Cellular	C	Concord	NC
4104800	France Telecom Corporate Solutions L.L.C.	Cellular	D	Oak Hill	VA
4109350	Global Connection Inc. of America	Cellular	D	Norcross	GA
4102200	Globalstar USA, LLC	Cellular	B	Covington	LA
4109600	Google North America Inc.	Cellular	A	Mountain View	CA
33350363	Granite Telecommunications, LLC	Cellular	D	Quincy	MA
4106000	GreatCall, Inc. d/b/a Jitterbug	Cellular	A	San Diego	CA
10630	GTE Wireless of the Midwest dba Verizon Wireless	Cellular	A	Basking Ridge	NJ
4110600	Horizon River Technologies, LLC	Cellular	C	Atlanta	GA
4103100	i-Wireless, LLC	Cellular	A	Newport	KY
4109800	IM Telecom, LLC d/b/a Infiniti Mobile	Cellular	D	Tulsa	OK
22215360	KDDI America, Inc.	Cellular	D	New York	NY
10872	Kentucky RSA #1 Partnership	Cellular	A	Basking Ridge	NJ
10680	Kentucky RSA #3 Cellular General	Cellular	A	Elizabethtown	KY
10681	Kentucky RSA #4 Cellular General	Cellular	A	Elizabethtown	KY
4109750	Konatel, Inc. dba telecom.mobi	Cellular	D	Johnstown	PA
4110900	Lunar Labs, Inc.	Cellular	C	Detroit	MI
4107300	Lycamobile USA, Inc.	Cellular	D	Newark	NJ
4108800	MetroPCS Michigan, LLC	Cellular	A	Bellevue	WA
4109650	Mitel Cloud Services, Inc.	Cellular	D	Mesa	AZ
4202400	New Cingular Wireless PCS, LLC dba AT&T Mobility, PCS	Cellular	A	San Antonio	TX
10900	New Par dba Verizon Wireless	Cellular	A	Basking Ridge	NJ
4000800	Nextel West Corporation	Cellular	D	Overland Park	KS
4001300	NPCR, Inc. dba Nextel Partners	Cellular	D	Overland Park	KS

4001800	OnStar, LLC	Cellular	A	Detroit	MI
4110750	Onvoy Spectrum, LLC	Cellular	C	Plymouth	MN
4109050	Patriot Mobile LLC	Cellular	D	Southlake	TX
4110250	Plintron Technologies USA LLC	Cellular	D	Bellevue	WA
33351182	PNG Telecommunications, Inc. dba PowerNet Global Communications	Cellular	D	Cincinnati	OH
4202100	Powertel/Memphis, Inc. dba T-Mobile	Cellular	A	Bellevue	WA
4107700	Puretalk Holdings, LLC	Cellular	A	Covington	GA
4106700	Q Link Wireless, LLC	Cellular	A	Dania	FL
4108700	Ready Wireless, LLC	Cellular	B	Hiawatha	IA
4110500	Republic Wireless, Inc.	Cellular	D	Raleigh	NC
4111100	ROK Mobile, Inc.	Cellular	C	Culver City	CA
4106200	Rural Cellular Corporation	Cellular	A	Basking Ridge	NJ
4108550	Sage Telecom Communications, LLC dba TruConnect	Cellular	D	Los Angeles	CA
4109150	SelecTel, Inc. d/b/a SelecTel Wireless	Cellular	D	Freemont	NE
4106300	SI Wirelless, LLC	Cellular	A	Carbondale	IL
4110150	Spectrotel, Inc. d/b/a Touch Base Communications	Cellular	D	Neptune	NJ
4200100	Sprint Spectrum, L.P.	Cellular	A	Atlanta	GA
4200500	SprintCom, Inc.	Cellular	A	Atlanta	GA
4109550	Stream Communications, LLC	Cellular	D	Dallas	TX
4110200	T C Telephone LLC d/b/a Horizon Cellular	Cellular	D	Red Bluff	CA
4202200	T-Mobile Central, LLC dba T-Mobile	Cellular	A	Bellevue	WA
4002500	TAG Mobile, LLC	Cellular	D	Carrollton	TX
4109700	Telecom Management, Inc. dba Pioneer Telephone	Cellular	D	South Portland	ME
4107200	Telefonica USA, Inc.	Cellular	D	Miami	FL
4108900	Telrite Corporation dba Life Wireless	Cellular	D	Covington	GA
4108450	Tempo Telecom, LLC	Cellular	D	Kansas City	MO
4109950	The People's Operator USA, LLC	Cellular	D	New York	NY
4109000	Ting, Inc.	Cellular	A	Toronto	ON
4110400	Torch Wireless Corp.	Cellular	D	Jacksonville	FL
4103300	Touchtone Communications, Inc.	Cellular	D	Whippany	NJ
4104200	TracFone Wireless, Inc.	Cellular	D	Miami	FL
4002000	Truphone, Inc.	Cellular	D	Durham	NC
4110300	UVNV, Inc.	Cellular	D	Costa Mesa	CA
4105700	Virgin Mobile USA, L.P.	Cellular	A	Atlanta	GA
4110800	Visible Service LLC	Cellular	C	Lone Tree	CO
4106500	WiMacTel, Inc.	Cellular	D	Palo Alto	CA
4110950	Wing Tel Inc.	Cellular	C	New York	NY
4109900	Wireless Telecom Cooperative, Inc. dba theWirelessFreeway	Cellular	D	Louisville	KY

13

S & S Tower Services
120 Branden Dr.
Mousie, KY 41839

Kentucky Public Service Commission
211 Sower Blvd.
P.O. Box 615
Frankfort, KY 40602-0615

Dear Commissioners:

The Construction Manager for the proposed communications facility will be Dave Strausbaugh. His contact information is (606) 497-6730 or dstrausbaugh010@gmail.com.

Dave has been in the industry completing civil construction and constructing towers since 1991. He has worked for S&S Tower Services since 2015 as Construction Manager overseeing the construction of telecommunications towers and sites.

Thank you,

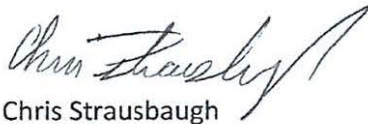

Chris Strausbaugh
Owner
S&S Tower Services
(606) 497-5798