

RECEIVED

JUL 7 2005

PUBLIC SERVICE
COMMISSION

LG&E ENERGY[®]

LG&E Energy LLC
220 West Main Street (40202)
P.O. Box 32030
Louisville, Kentucky 40232

July 7, 2005

Elizabeth O'Donnell
Executive Director
Kentucky Public Service Commission
211 Sower Boulevard
Frankfort, Kentucky 40602-0615

RE: Joint Application of Louisville Gas and Electric Company and Kentucky Utilities Company for a Certificate of Public Convenience and Necessity for the Construction of Transmission Facilities in Jefferson, Bullitt, Meade and Hardin Counties, Kentucky
Case No. 2005-00142

Application of Kentucky Utilities Company for a Certificate of Public Convenience and Necessity for the Construction of Transmission Facilities in Franklin, Woodford and Anderson Counties, Kentucky
Case No. 2005-00154

Application of Louisville Gas and Electric Company for a Certificate of Public Convenience and Necessity for the Construction of Transmission Facilities in Trimble County, Kentucky
Case No. 2005-00155

Dear Ms. O'Donnell:

Enclosed please find an original and ten (10) copies of Louisville Gas and Electric Company's ("LG&E") and Kentucky Utilities Company's ("KU") Response to the Commission Staff's First Data Request dated June 30, 2005 in the above-referenced dockets.

Should you have any questions concerning the enclosed, please do not hesitate to contact me at (502) 627-4110.

Sincerely,



John Wolfram
Manager, Regulatory Affairs

cc: Parties of Record

COMMONWEALTH OF KENTUCKY
BEFORE THE PUBLIC SERVICE COMMISSION

In the Matter of:

JOINT APPLICATION OF LOUISVILLE GAS)	
AND ELECTRIC COMPANY AND KENTUCKY)	
UTILITIES COMPANY FOR A CERTIFICATE)	
OF PUBLIC CONVENIENCE AND NECESSITY)	CASE NO.
FOR CONSTRUCTION OF TRANSMISSION)	2005-00142
FACILITIES IN JEFFERSON, BULLITT, MEADE,)	
AND HARDIN COUNTIES, KENTUCKY)	

In the Matter of:

APPLICATION OF KENTUCKY UTILITIES)	
COMPANY FOR A CERTIFICATE OF PUBLIC)	
CONVENIENCE AND NECESSITY FOR THE)	CASE NO.
CONSTRUCTION OF TRANSMISSION)	2005-00154
FACILITIES IN FRANKLIN, WOODFORD)	
AND ANDERSON COUNTIES, KENTUCKY)	

In the Matter of:

APPLICATION OF LOUISVILLE)	
GAS AND ELECTRIC COMPANY FOR)	
A CERTIFICATE OF PUBLIC CONVENIENCE)	CASE NO.
AND NECESSITY FOR THE CONSTRUCTION)	2005-00155
OF TRANSMISSION FACILITIES IN)	
TRIMBLE COUNTY, KENTUCKY)	

RESPONSE OF
LOUISVILLE GAS AND ELECTRIC COMPANY
AND
KENTUCKY UTILITIES COMPANY
TO COMMISSION STAFF'S
FIRST DATA REQUEST
DATED JUNE 30, 2005

FILED: July 7, 2005

**LOUISVILLE GAS AND ELECTRIC COMPANY
KENTUCKY UTILITIES COMPANY**

CASE NO. 2005-00142

CASE NO. 2005-00154

CASE NO. 2005-00155

**Response to Commission Staff's First Data Request
Dated: June 30, 2005**

Question No. 1

Responding Witness: Michael G. Toll / David S. Sinclair

Q-1. Supply the long-range system real and reactive load forecasts (loads by year only) used by transmission planners in the years 2000 through 2005.

A-1. The annual forecast is provided in the 2005 Joint Integrated Resource Plan of Louisville Gas and Electric Company and Kentucky Utilities Company, Case No. 2005-00162, incorporated here by reference. This forecast is a real-power (i.e. MW) forecast; the reactive power (i.e. MVAR) for each station is developed for the transmission planning load flow model(s) from the previous year actual system peak measurements and as such is unavailable in the format requested. The reactive load at each station includes the distribution reactive load plus reactive losses through the distribution transformers.

**LOUISVILLE GAS AND ELECTRIC COMPANY
KENTUCKY UTILITIES COMPANY**

CASE NO. 2005-00142

CASE NO. 2005-00154

CASE NO. 2005-00155

**Response to Commission Staff's First Data Request
Dated: June 30, 2005**

Question No. 2

Responding Witness: David S. Sinclair

Q-2. Supply the most recent long-range load forecast in total .

A-2. The forecast is provided in the 2005 Joint Integrated Resource Plan of Louisville Gas and Electric Company and Kentucky Utilities Company, Case No. 2005-00162, incorporated here by reference.

**LOUISVILLE GAS AND ELECTRIC COMPANY
KENTUCKY UTILITIES COMPANY**

CASE NO. 2005-00142

CASE NO. 2005-00154

CASE NO. 2005-00155

**Response to Commission Staff's First Data Request
Dated: June 30, 2005**

Question No. 3

Responding Witness: David S. Sinclair

- Q-3. For the load forecasts supplied, provide a short narrative of any changes that have been made in forecasting methods, models, or major assumptions. Include in the narrative any changes to the probability of occurrence or weather normalization.
- A-3. The changes to the forecast methods, models, or assumptions are discussed in Section 6 of the 2005 Joint Integrated Resource Plan of Louisville Gas and Electric Company and Kentucky Utilities Company, Case No. 2005-00162, incorporated here by reference.

**LOUISVILLE GAS AND ELECTRIC COMPANY
KENTUCKY UTILITIES COMPANY**

CASE NO. 2005-00142

CASE NO. 2005-00154

CASE NO. 2005-00155

Response to Commission Staff's First Data Request

Dated: June 30, 2005

Question No. 4

Responding Witness: Michael G. Toll

Q-4. Describe the relay systems and relay types to be installed to integrate the new facilities into the transmission system. Include in your description primary, secondary, and back-up protection systems.

A-4. The typical protection scheme for the 345 kV system consists of a dual primary system (Directional Comparison Blocking and Permissive Overreaching Transfer Trip). Backup protection is provided by Zone 2 and Ground Overcurrent relays

The typical protection scheme for the 138 kV system consists of communication assisted Directional Comparison Blocking systems. Backup protection is provided by Ground Overcurrent relays.

**LOUISVILLE GAS AND ELECTRIC COMPANY
KENTUCKY UTILITIES COMPANY**

CASE NO. 2005-00142

CASE NO. 2005-00154

CASE NO. 2005-00155

**Response to Commission Staff's First Data Request
Dated: June 30, 2005**

Question No. 5

Responding Witness: Mark S. Johnson

- Q-5. Were alternatives considered and studied for each project? If yes, describe the alternatives and state the reasons for selecting the proposed project over the alternatives.
- A-5. The alternatives considered are described in the studies included in Exhibits MSJ-1, MSJ-2 and MSJ-3 attached to the testimony of Mark S. Johnson, and the reason for choosing the proposed project is discussed in that testimony. Also please see the response to Question No. 10.

**LOUISVILLE GAS AND ELECTRIC COMPANY
KENTUCKY UTILITIES COMPANY**

**CASE NO. 2005-00142
CASE NO. 2005-00154
CASE NO. 2005-00155**

**Response to Commission Staff's First Data Request
Dated: June 30, 2005**

Question No. 6

Responding Witness: Michael G. Toll

- Q-6. Provide the executive summaries of LG&E/KU, Midwest Independent System Operator, Inc. ("MISO"), or North American Electric Reliability Council ("NERC") transient stability, long-term dynamics, power flow, short circuit, switching surge, lightning protection, and step/touch potential studies done in connection with the projects or alternatives. (Note: Full copies of the studies and model assumptions should be available for discussion when interviews take place.)
- A-6. Please see Exhibits MSJ-1, MSJ-2, and MSJ-3 attached to the testimony of Mark S. Johnson. Also please see the response to Question No. 10. Switching surge, lightning protection and step/touch potential studies will be completed during the final station designs.

**LOUISVILLE GAS AND ELECTRIC COMPANY
KENTUCKY UTILITIES COMPANY**

**CASE NO. 2005-00142
CASE NO. 2005-00154
CASE NO. 2005-00155**

**Response to Commission Staff's First Data Request
Dated: June 30, 2005**

Question No. 7

Responding Witness: Michael G. Toll

Q-7. Provide diagrams for the three projects that show the physical layout of the project additions at existing substations (e.g., breaker layouts).

A-7. Please see attached.

TRIMBLE COUNTY

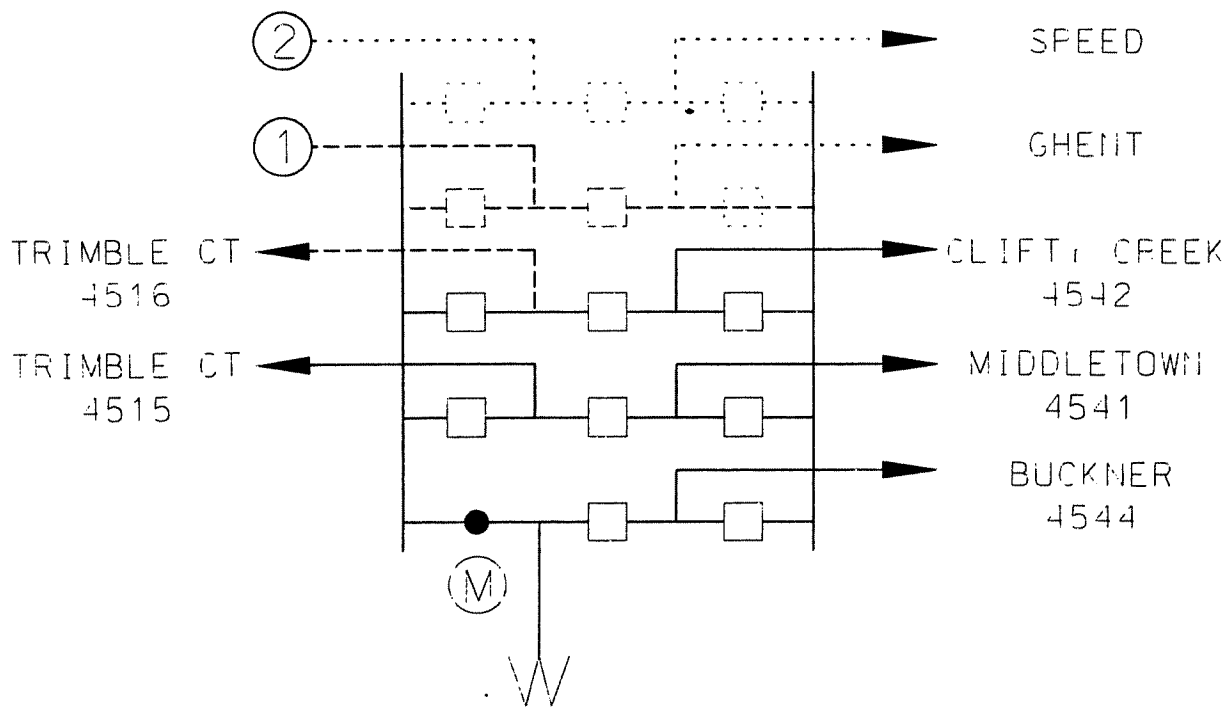

----- CT E-PAUSION (TC1 MOVES TO NEW BA)

..... TC2 E-PAUSION

MILL CREEK

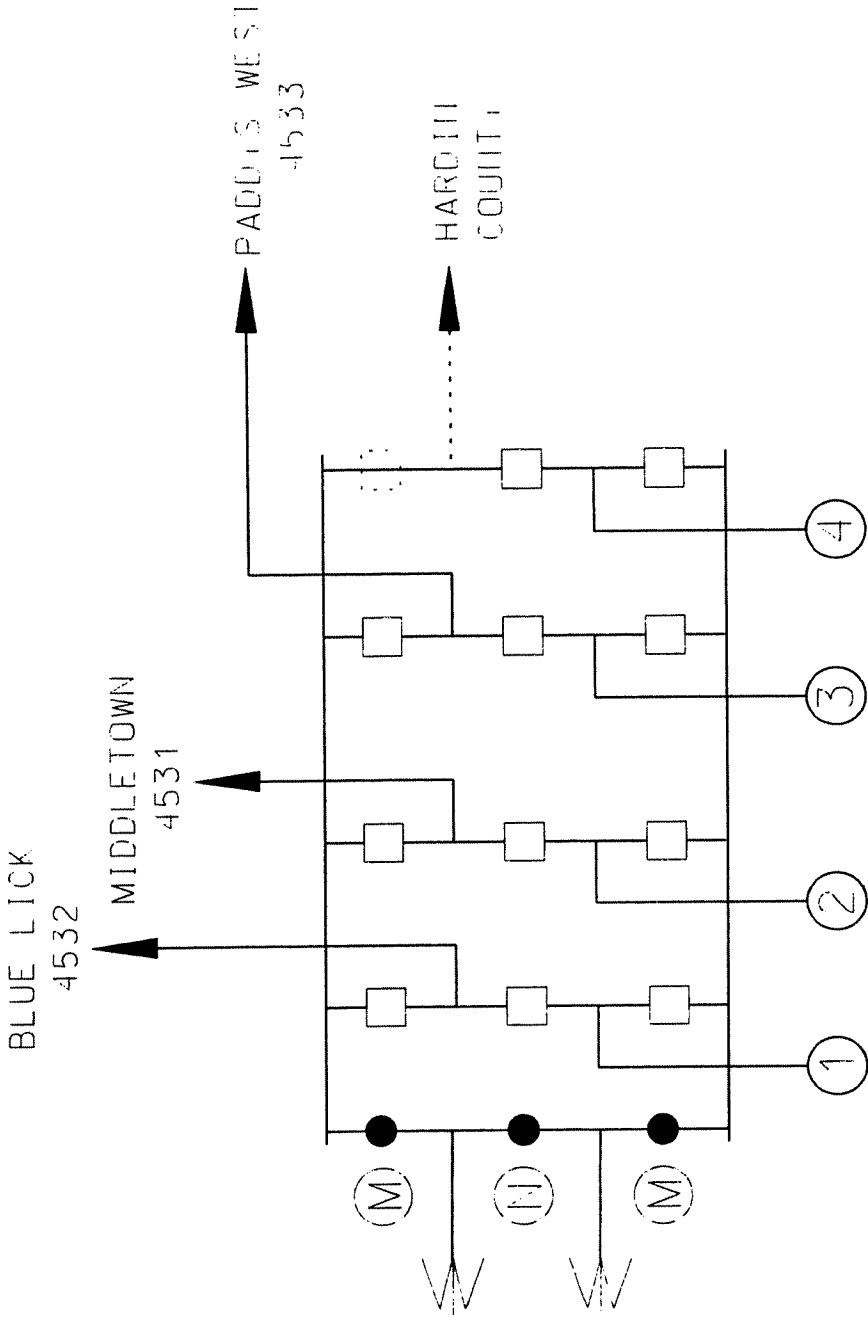

HARDIN COUNTY

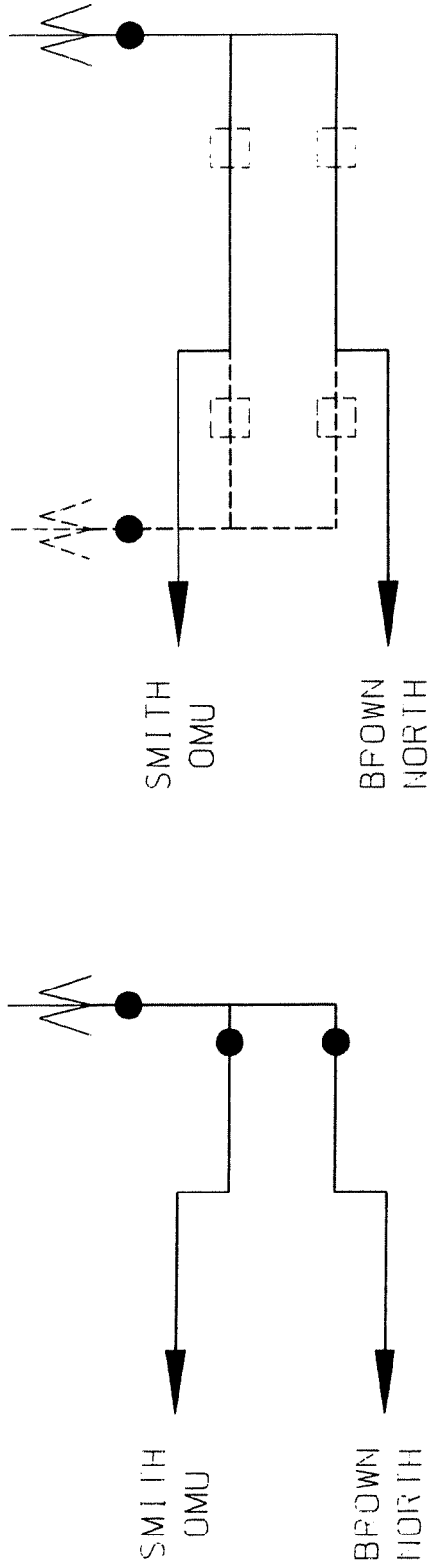

EXISTING

TFR 2 ADDITION

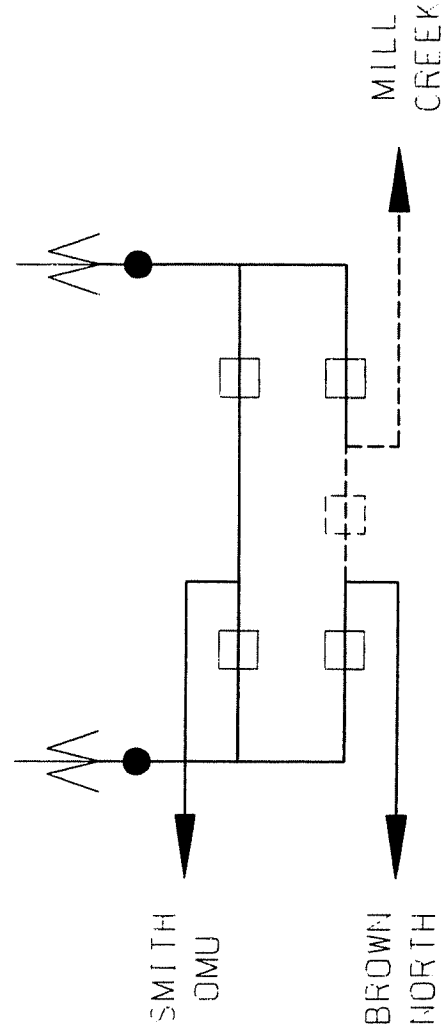

----- ADDITION

..... REMOVE

TC2 EXPANSION

TYRONE

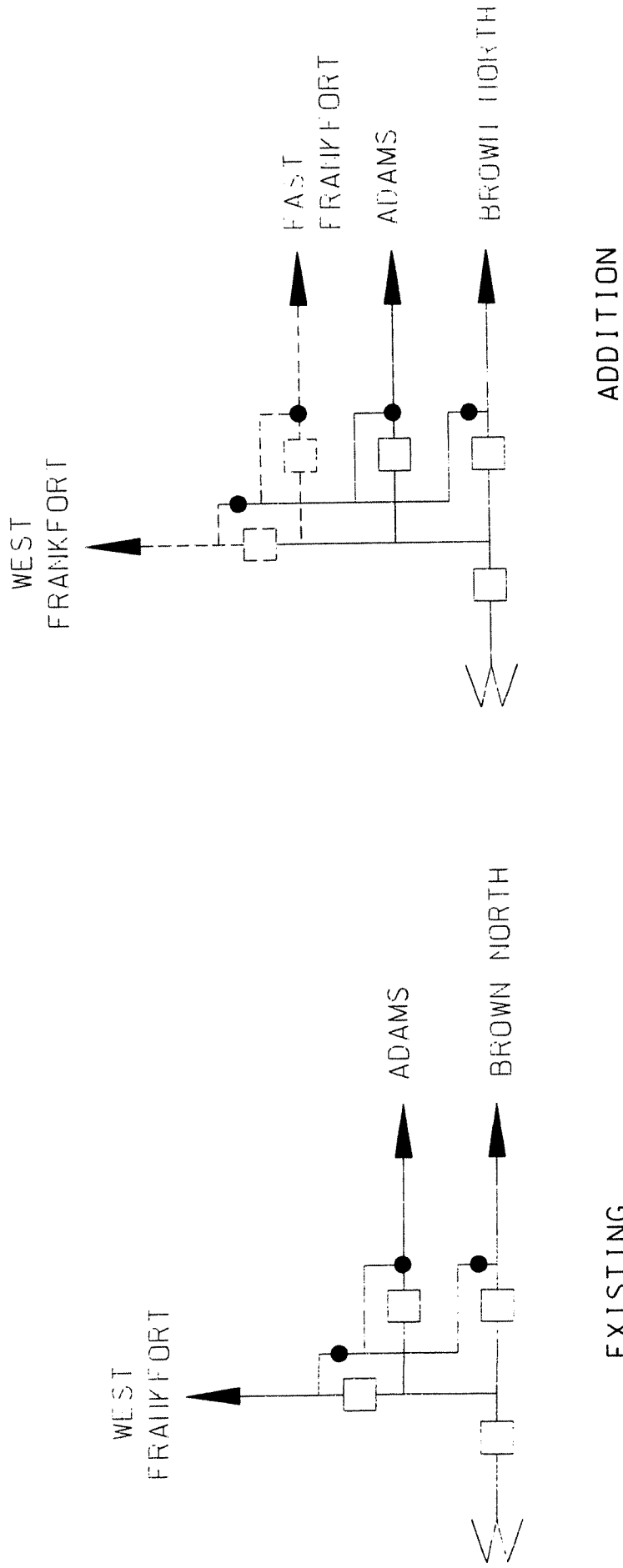

EXISTING

ADDITION

NOTE:
ADD BAY, MOVE BREAKER, RE-TERMINATE E. FRANKFORT,
AND ADD W. FRANKFORT.

WEST
FRANKFORT

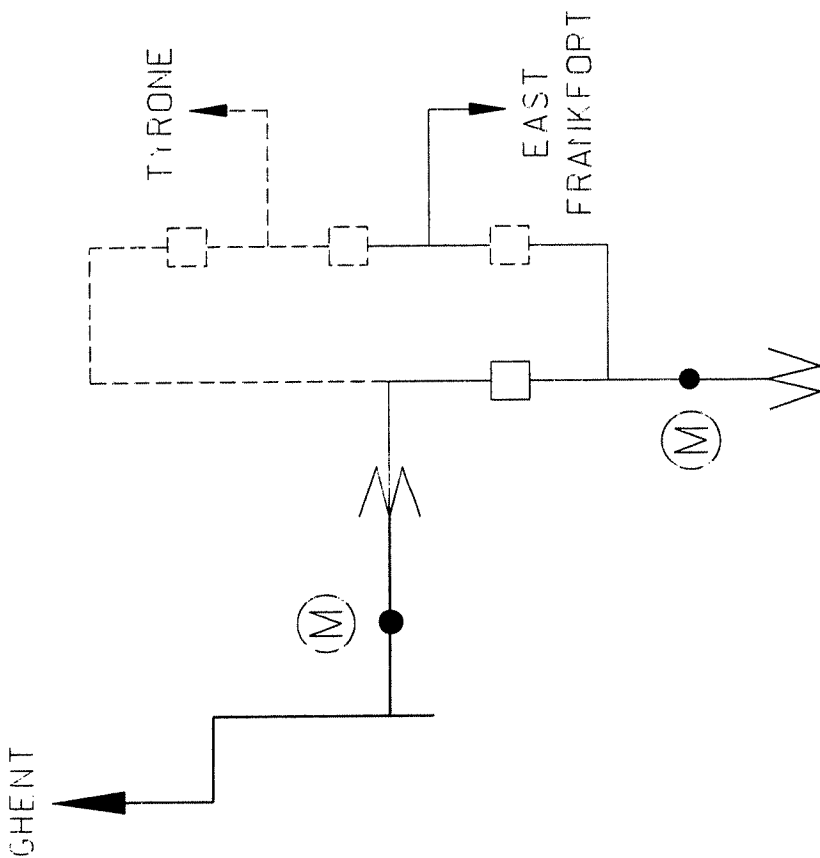

**LOUISVILLE GAS AND ELECTRIC COMPANY
KENTUCKY UTILITIES COMPANY**

**CASE NO. 2005-00142
CASE NO. 2005-00154
CASE NO. 2005-00155**

**Response to Commission Staff's First Data Request
Dated: June 30, 2005**

Question No. 8

Responding Witness: Mark S. Johnson

- Q-8. Provide a short description of each project, including the various components required, major component cost (e.g., line, substation at each end, and major river crossings), and length.
- A-8. Please see paragraphs 2, 5, 6, 8, 9, 10 and 11 of the Application filed in this proceeding. Also please see the testimony of Mark S. Johnson and Nate Mullins.

**LOUISVILLE GAS AND ELECTRIC COMPANY
KENTUCKY UTILITIES COMPANY**

**CASE NO. 2005-00142
CASE NO. 2005-00154
CASE NO. 2005-00155**

**Response to Commission Staff's First Data Request
Dated: June 30, 2005**

Question No. 9

Responding Witness: Nate Mullins

- Q-9. Explain in detail the routing each line will follow and include the name of the owner of the utility and the physical placement of the line in the corridor.
- A-9. Please see the testimony and exhibits of Nate Mullins filed in this proceeding.

**LOUISVILLE GAS AND ELECTRIC COMPANY
KENTUCKY UTILITIES COMPANY**

CASE NO. 2005-00142

CASE NO. 2005-00154

CASE NO. 2005-00155

**Response to Commission Staff's First Data Request
Dated: June 30, 2005**

Question No. 10

Responding Witness: Mark S. Johnson / Michael G. Toll

- Q-10. State the justification for each project. Include any reliability criteria that are violated under current conditions, and that would be resolved through construction of each project.
- A-10. Please see the MISO studies provided as Exhibits MSJ-1, MSJ-2, and MSJ-3 to the testimony of Mark S. Johnson. Also please see the attached documents:
1. Trimble County #2 System Impact/Facilities Study: Internal Study conducted by LG&E Energy Transmission Planning
 2. Facility Study Report, Project G218(MISO Queue #37356-01) dated July 10, 2003
 3. Appendices to G218 Report provided as Exhibit MSJ-2

Trimble County #2 System Impact/Facilities Study

Internal Study conducted by LG&E Energy Transmission Planning

Introduction

LG&E Energy has proposed a 750 MW coal-fueled generator to be constructed at Trimble County. LG&E Energy Transmission Planning has conducted a transmission interconnection study to assess the impacts of this unit on the LGEE and surrounding transmission systems, and to identify possible transmission expansion options to accommodate the unit. This study was initiated for informational purposes. The Midwest ISO is responsible for conducting Generator Interconnection and Transmission Service studies for LGEE to determine the actual impacts of and requirements for interconnection and transmission service requests. The study conducted by LGEE's Transmission Planning group is meant to provide advance information regarding potential construction scenarios that had been discussed previously. This study should not be used by LGEE to discredit or refute the results of the MISO studies.

Methodology

The study used a 2007 Summer peak case developed by LGEE Transmission Planning. A 750 MW unit at Trimble County was included in the model, with 75% of the output used to serve LGEE native load, and the remaining 25% exported to IMPA and IMEA. Additionally, all six 152 MW CTs planned for Trimble County were dispatched for native load, with the CTs at Brown reduced to near zero MW output. No transfers were modeled other than those included in the NERC MMWG 2007 Summer case used as the basis for this model. The LGEE and surrounding utilities' transmission systems were assessed to determine thermal overloads under this scenario. Potential construction scenarios were tested to determine their ability to eliminate overloads. Costs were assigned to these scenarios using rule-of-thumb estimates. Detailed estimates will be required to determine more accurate costs for any scenarios of interest.

Results

The results of the study are shown in Table 1 below. Only significant transmission limits at 138 kV and above were identified in this analysis and listed in Table 1 in order to identify the major issues associated with this new unit. There are additional limits due to relatively minor limitations, such as insufficient phase-to-ground clearance, station terminal limits, or 69 kV facility overloads. Table 1 shows the overloaded facilities without any new transmission added, and for each of the five options considered as possible transmission expansion plans in conjunction with the new unit.

- Option 1:** Loop Ghent-Speed 345 kV through Trimble County and construct West Frankfort-Brown 345 kV line
- Option 2:** Loop Ghent-Speed 345 kV through Trimble County and construct Mill Creek-Hardin County 345 kV line
- Option 3:** Construct Trimble County-West Frankfort and West Frankfort-Brown 345 kV lines
- Option 4:** Construct West Frankfort-Brown and Mill Creek-Hardin County 345 kV lines
- Option 5:** Construct Trimble County-West Frankfort, West Frankfort-Brown, and Mill Creek-Hardin County 345 kV lines

**Table 1
Trimble County #2 Study Results**

MVA Flow								
Limiting Facility	Contingent Element	Rating	No Const ructio n	Optio n 1	Opti on 2	Optio n 3	Optio n 4	Optio n 5
				GH- TC- SP, WF- BR 345	GH- TC- SP, MC- HC 345	TC- WF- BR 345	WF- BR, MC- HC 345	TC- WF- BR, MC- HC 345
Avon-Loudon Avenue 138 kV	None	292	319	295	288	281	294	271
Avon-Loudon Avenue 138 kV	Ghent-West Lexington-Brown 345 kV	363	440	406	398	389	398	377
West Frankfort-Frankfort East 138 kV	Ghent-West Lexington-Brown 345 kV	303	315	192	293	245	196	244
Frankfort East-Tyrone 138 kV	Ghent-West Lexington-Brown 345 kV	220	212	114	180	139	104	130
Ghent-Owen County Tap 138 kV	Ghent-West Lexington-Brown 345 kV	277	284	260	265	249	241	242
Blue Lick-Bullitt County 161 kV	Trimble County-Clifty Creek 345 kV	239	338	249	198	236	226	188
Blue Lick 345/161 kV	Trimble County-Clifty Creek 345 kV	276	338	249	198	236	226	188
Blue Lick-Bullitt County 161 kV	Trimble County-West Frankfort 345 kV	239	NA	NA	NA	253	NA	194
Blue Lick 345/161 kV	Trimble County-West Frankfort 345 kV	276	NA	NA	NA	253	NA	194
Blue Lick-Bullitt County 161 kV	Mill Creek-Hardin County 345 kV	239	NA	NA	241	NA	249	217
Blue Lick 345/161 kV	Mill Creek-Hardin County 345 kV	276	NA	NA	241	NA	249	217
Middletown-3870 Tap 138 kV	Middletown-Bluegrass Parkway 138 kV	271	282	261	263	265	280	265
Middletown 345/138 kV #1	Middletown 345/138 kV #3	478	561	530	526	532	550	527
Middletown 345/138 kV #2	Middletown 345/138 kV #1	478	534	504	500	506	523	501
Middletown 345/138 kV #3	Middletown 345/138 kV #1	478	543	513	510	515	532	510
Trimble County-Buckner 345 kV	Trimble County-Middletown 345 kV	1195	1175	986	1129	976	1286	1087
Buckner-Middletown 345 kV	Trimble County-Middletown 345 kV	1195	1297	1120	1256	1134	1404	1216
Trimble County-Middletown 345 kV	Buckner-Middletown 345 kV	1195	1317	1126	1261	1143	1421	1220
Bus	Contingent Element	Bus Voltage						
		No Const	Opt 1	Opt 2	Opt 3	Opt 4	Opt 5	
Hardin County 138 kV	Brown North-Hardin County 345 kV		96.20%	96.90%	100.0%	96.90%	99.30%	99.40%
MW Loss Reduction			0	2.8	6.4	4.0	6.4	7.2

The results indicate that with no new transmission facilities modeled for Trimble County Unit #2 there are 11 unique facilities at 138 kV and above that are overloaded, and there are 7 unique contingencies that create these overloads.

Each of the five options evaluated eliminates the thermal overloads with varying success. All options eliminate the problems associated with the Ghent-West Lexington-Brown 345 kV outage, other than the Avon-Loudon Avenue 138 kV line overload. None of the five options identified eliminate the overloads of the Middletown 345/138 kV transformers. These transformers are limited by 138 kV, 2000A terminal equipment to 478 MVA and by the summer emergency rating of the transformers themselves to 515 MVA. A possible remedy for these overloads would be installation of a fourth 345/138 kV transformer in the Middletown area. One other issue to be considered is the voltage levels in the Hardin County area of the system. This area of the LGEE transmission system is expected to potentially have marginal voltage levels in the future. The options which include the Mill Creek-Hardin County 345 kV line provide a significant boost to voltages in the area, as shown in Table 1, whereas the other options provide no significant increase.

A brief discussion of the impact of each option on the system follows:

Option 1

Option 1 involves constructing 2.8 miles of double-circuit 345 kV line from the Trimble County substation across the Ohio River to the Ghent to Speed (CIN) 345 kV line, which is owned by Cinergy in Indiana. This would result in a 345 kV line between Ghent and Trimble County and a 345 kV line between Speed and Trimble County. Also, a 345 kV line would be constructed between West Frankfort and Brown, a distance of about 30 miles.

This option results in the 2000A terminal equipment on the Trimble-Middletown 345 kV double-circuit lines being adequate for expected contingency flows. This option also reduces the contingency flow on the Blue Lick 345/161 kV transformer such that it is no longer overloaded. The Blue Lick-Bullitt County 161 kV line would still be overloaded, but the level is such that increasing the phase-to-ground clearance of the existing conductors would eliminate the problem.

This option has an estimated investment of approximately \$40.6 million dollars. However, additional investment from LG&E Energy may be required by Cinergy to construct dedicated facilities to loop Cinergy's Ghent-Speed line into LGEE's Trimble County substation. This option reduces losses by about 2.8 MW compared to constructing no facilities for summer peak load levels. A 2.8 MW reduction in transmission system losses over a 45-year period has a present value savings of approximately \$1.1 million.

Option 2

Option 2 involves constructing 2.8 miles of double-circuit 345 kV line from the Trimble County substation across the Ohio River to the Ghent to Speed (CIN) 345 kV line, which

is owned by Cinergy in Indiana. This would result in a 345 kV line between Ghent and Trimble County and a 345 kV line between Speed and Trimble County. Also, a 345 kV line would be constructed between Mill Creek and Hardin County, a distance of about 43 miles.

This option results in the 2000A terminal equipment on the Trimble-Middletown 345 kV double-circuit lines being inadequate, requiring an upgrade of this equipment. This option does reduce the contingency flow on the Blue Lick 345/161 kV transformer such that it is no longer overloaded. The Blue Lick-Bullitt County 161 kV line would still be overloaded, but the level is such that increasing the phase-to-ground clearance of the existing conductors would eliminate the problem.

This option has an estimated investment of approximately \$59.1 million dollars. However, additional investment from LG&E Energy may be required by Cinergy to construct dedicated facilities to loop Cinergy's Ghent-Speed line into LG&E's Trimble County substation. This option reduces losses by about 6.4 MW for summer peak load levels compared to constructing no facilities, which would result in a net present value savings of about \$2.5 million over a 45-year period.

Option 3

Option 3 involves constructing 37 miles of 345 kV line between Trimble County and West Frankfort and 30 miles of 345 kV line between West Frankfort and Brown.

This option results in the 2000A terminal equipment on the Trimble-Middletown 345 kV double-circuit lines being adequate. This option also reduces the contingency flow on the Blue Lick 345/161 kV transformer such that it is no longer overloaded. The Blue Lick-Bullitt County 161 kV line would still be overloaded, but the level is such that increasing the phase-to-ground clearance of the existing conductors would eliminate the problem.

This option has an estimated investment of approximately \$75.7 million dollars. The option reduces losses by about 4.0 MW compared to constructing no facilities for summer peak load levels. This loss reduction results in a present value savings of about \$1.6 million over a 45-year period.

Option 4

Option 4 involves constructing 30 miles of 345 kV line between West Frankfort and Brown, and 43 miles of 345 kV line between Mill Creek and Hardin County.

This option results in the 2000A terminal equipment on the Trimble-Middletown 345 kV double-circuit lines being significantly overloaded. This option does reduce the contingency flow on the Blue Lick 345/161 kV transformer such that it is no longer overloaded. The Blue Lick-Bullitt County 161 kV line would still be overloaded, but the level is such that increasing the phase-to-ground clearance of the existing conductors would eliminate the problem. Also, the Middletown 345/138 kV transformer overloads are more severe for this option when compared to the other options considered. Finally,

this option would not eliminate the contingency overload of the Middletown-3870 Tap section of the Middletown-Plainview-Beargrass 138 kV line, whereas the other options do.

This option has an estimated investment of approximately \$83.3 million dollars. This option reduces losses by about 6.4 MW compared to constructing no facilities for summer peak load levels, resulting in a present value savings of about \$2.5 million over a 45-year period.

Option 5

Option 5 involves constructing 37 miles of 345 kV line between Trimble County and West Frankfort, 30 miles of 345 kV line between West Frankfort and Brown, and 43 miles of 345 kV line between Mill Creek and Hardin County.

This option results in the 2000A terminal equipment on the Trimble-Middletown 345 kV double-circuit lines being overloaded. This option reduces the contingency flows on the Blue Lick 345/161 kV transformer and the Blue Lick-Bullitt County 161 kV line such that both are no longer overloaded.

This option has an estimated investment of approximately \$125.6 million dollars. This option reduces losses by about 7.2 MW compared to constructing no facilities for summer peak load levels. This loss reduction would provide a present value of savings of \$2.8 million over a 45-year period.

Conclusions

Table 2 lists the overloaded facilities identified for the five construction options considered. This table indicates that the remaining problems for all five options are for the most part similar. All options would require additional construction to eliminate the Avon-Loudon Avenue 138 kV line overload, and the Middletown 345/138 kV transformer overloads. Note that the contingency flows for these facilities are not significantly different between the five options.

Options 1-4 would require the Blue Lick-Bullitt County 161 kV line summer emergency rating to be increased to at least the summer emergency rating of the Blue Lick 345/161 kV transformer (276 MVA). Options 2, 4, and 5 would each require upgrades to the 2000A terminal equipment associated with the Trimble County-Middletown double-circuit 345 kV lines. Also, Option 4 would require construction to eliminate the Middletown-3870 Tap 138 kV overload.

The options as modeled range in cost (including the benefit of loss reductions) from a low of \$39.5M to a high of \$122.8M. The two options which interconnect with Cinergy are significantly less expensive than the options involving only internal construction between LGEE facilities. However, additional cost may be required to satisfy Cinergy interconnection requirements. Also, additional cost may be required by MISO to satisfy network issues outside of the LGEE control area which are impacted by the second Trimble County unit. Table 3 identifies the itemized cost for each option as modeled.

Table 2
Trimble County #2 Remaining Overloaded Facilities

Limiting Facility	Contingent Element	Rating	MVA Flow				
			Option 1	Option 2	Option 3	Option 4	Option 5
			GH-TC-SP, WF-BR 345	GH-TC-SP, MC-HC 345	TC-WF-BR 345	WF-BR, MC-HC 345	TC-WF-BR, MC-HC 345
Avon-Loudon Avenue 138 kV	None	292	295			294	
Avon-Loudon Avenue 138 kV	Ghent-West Lexington-Brown 345 kV	363	406	398	389	398	377
Blue Lick-Bullitt County 161 kV	Trimble County-Clifty Creek 345 kV	239	249				
Blue Lick-Bullitt County 161 kV	Trimble County-West Frankfort 345 kV	239			253		
Blue Lick-Bullitt County 161 kV	Mill Creek-Hardin County 345 kV	239		241		249	
Middletown-3870 Tap 138 kV	Middletown-Bluegrass Parkway 138 kV	271				280	
Middletown 345/138 kV #1	Middletown 345/138 kV #3	478	530	526	532	550	527
Middletown 345/138 kV #2	Middletown 345/138 kV #1	478	504	500	506	523	501
Middletown 345/138 kV #3	Middletown 345/138 kV #1	478	513	510	515	532	510
Trimble County-Buckner 345 kV	Trimble County-Middletown 345 kV	1195				1286	
Buckner-Middletown 345 kV	Trimble County-Middletown 345 kV	1195		1256		1404	1216
Trimble County-Middletown 345 kV	Buckner-Middletown 345 kV	1195		1261		1421	1220
Construction Costs (\$M)			40.6	59.1	75.7	83.3	125.6
Savings from Loss Reduction (\$M)			1.1	2.5	1.6	2.5	2.8
Net Cost (\$M)			39.5	56.6	74.1	80.8	122.8

Table 3
Required Investment for Trimble County #2 Transmission Construction Options

	Cost (\$M)
Option 1	
Construct 2.8 miles of double-circuit 345 kV from Trimble County to Ghent-Speed	5.2
Construct 30.4 miles of 345 kV line between West Frankfort and Brown	30.4
Install four 345 kV breakers at Trimble County	4.0
Install one 345 kV breaker at Brown	1.0
Total	40.6
Option 2	
Construct 2.8 miles of double-circuit 345 kV from Trimble County to Ghent-Speed	5.2
Construct 42.9 miles of 345 kV line between Mill Creek and Hardin County	44.9
Install four 345 kV breakers at Trimble County	4.0
Install one 345 kV breaker at Mill Creek	1.0
Install four 345 kV breakers at Hardin County	4.0
Total	59.1
Option 3	
Construct 37.3 miles of 345 kV line between Trimble County and West Frankfort	37.3
Construct 30.4 miles of 345 kV line between West Frankfort and Brown	30.4
Install three 345 kV breakers at Trimble County	3.0
Install four 345 kV breakers at West Frankfort	4.0
Install one 345 kV breaker at Brown	1.0
Total	75.7
Option 4	
Construct 30.4 miles of 345 kV line between West Frankfort and Brown	30.4
Construct 42.9 miles of 345 kV line between Mill Creek and Hardin County	44.9
Install two 345 kV breakers at Trimble County	2.0
Install one 345 kV breaker at Brown	1.0
Install one 345 kV breaker at Mill Creek	1.0
Install four 345 kV breakers at Hardin County	4.0
Total	83.3
Option 5	
Construct 37.3 miles of 345 kV line between Trimble County and West Frankfort	37.3
Construct 30.4 miles of 345 kV line between West Frankfort and Brown	30.4
Construct 42.9 miles of 345 kV line between Mill Creek and Hardin County	44.9
Install three 345 kV breakers at Trimble County	3.0
Install four 345 kV breakers at West Frankfort	4.0
Install one 345 kV breaker at Brown	1.0
Install one 345 kV breaker at Mill Creek	1.0
Install four 345 kV breakers at Hardin County	4.0
Total	125.6

Project G218 #37356-01
Generation Interconnection Facility Study Report
July 10, 2003

Facility Study Report

Project G218 (MISO Queue #37356-01)
750 MW Generating Power Plant at Trimble County, KY

Prepared By

Engineering Department
Midwest ISO
701 City Center Dr.
Carmel, IN 46032

July 10, 2003

Table of Contents

	<u>Page Number</u>
Executive Summary	3
1. Introduction	4
2. Assumptions	5
3. Construction Cost and Schedule	5
4. Identification of Costs Eligible for Credits	6
5. Reviews and Analysis of Generation Interconnection Evaluation Study	7
6. Conclusions	8

Executive Summary

A request for a generation interconnection of a 750 MW generating power plant in Trimble County, KY (Generator) was made to Midwest ISO and was assigned Queue Number 37356-01 and Project Number G218. A generation interconnection evaluation study was performed by MISO and a study report was published. MISO has performed the corresponding facility study. The results of this study have been presented in this report.

An earlier study on the delivery of power from this generator (see system impact study report on project A024 for request # 75052130 posted on MISO OASIS) has revealed that there were multiple system deficiencies. Four facility upgrade options were identified to alleviate system network problems. After further review, LG&E Energy Transmission chose Option #4 as the preferred option. The looping of the Ghent-Speed 345 KV line through the Trimble Co. 345 KV substation was identified as the minimum necessary upgrades to facilitate interconnection of the generator and was included in this study.

The total cost to interconnect the proposed generator to the network has been estimated to be \$8,569,112 in 2007 dollars. All the system upgrades are in the LG&E Energy Transmission system.

The total interconnection cost was further analyzed to identify the direct interconnection cost and the system upgrade cost. MISO's definition of direct connect is the radial from the GSU to the substation. Usually breakers in a breaker and a half scheme are considered upgrades. If breaker is direct connect between the GSU and the sub (i.e. radial) it is a direct connect cost to the Generator otherwise in any network flow through configuration it is a system upgrade. The cost of the take-off structure at the Trimble 345 KV substation and the associated work was assigned to the direct interconnection cost. Therefore, the remaining cost of \$8,443,857 in 2007 dollars is eligible for credits to the developer toward the future use of the transmission services. LG&E Energy Transmission contests the MISO definition. LG&E Energy Transmission considers the take-off structure, one breaker, two disconnects and the associated facilities as part of the cost to connect the Generator. The associated costs for this project is \$745,766 in 2007 dollars.

The study has identified the key events and the schedule for those events in order to achieve a commercial operation date of January 1, 2007. The necessary time for the transmission-line work related to looping the Speed – Ghent 345 KV line through the Trimble 345 KV substation has been identified as one of the longest, and must start around October 1, 2003 in order to meet the deadline. The schedule in the report will need to be updated in the event the in-service date of the proposed generator changes.

1. Introduction

A request for a generation interconnection of a 750 MW generating power plant in Trimble County, KY (Generator) was made to Midwest ISO. The MISO Generation Interconnection Request Queue Number for this request is 37356-01. This project is also known as Project G218. MISO has coordinated the Generation Interconnection Facility Study (the "Study") for this project. The results of this study are presented in this report.

An earlier study on the delivery of power from this generator (see system impact study report on project A024 for request # 75052130 posted on MISO OASIS) has revealed that there were multiple system deficiencies. Four facility upgrade options were identified to alleviate system network problems. After further review, LG&E Energy Transmission chose Option #4 as the preferred option.

The facility upgrades related to option 4 are given below –

Loop the existing Ghent (LGEE)-Speed (CIN) 345 kV line through the Trimble County substation.

Construct a 345kV line from Mill Creek to Hardin County

Construct a 138kV line from West Lexington to Higby Mill

Construct a 138 kV line from West Frankfort to Tyrone

Re-conductor the 138kV line from Ghent to Owen County Tap

Re-conductor the 138kV line from Hardin County to Etown

Open the 69kV tie from Shelby County (EKPC) to Shelby County Tap (LGEE)

Upgrade the West Frankfort 345/138 KV transformer low-side breaker

Upgrade the disconnects at Carrolton on the Carrolton to Frankfort East 138 KV line

The facility study was split into two separate studies. One related to the generation interconnection request and the other related to the delivery request. This report covers the facility study related to the generation interconnection request.

The looping of the Ghent-Speed 345 KV line through the Trimble Co. 345 KV substation was identified as the minimum necessary upgrades to facilitate interconnection of the generator. The remaining facility upgrades have been addressed as part of the delivery request #75052130.

Cinergy and LG&E Energy Transmission performed the facility study. Cinergy assessed the work to be done at the Speed 345 KV substation and LG&E Energy Transmission assessed the work to be done at the Trimble and Ghent 345 KV substations. The results from these two studies have been compiled in this report.

2. Assumptions

- **In-service date**
The in-service date of this project is January 1, 2007.
- **Testing Period**
As informed by the developer, the testing period will be 6-months. All the electrical work on the transmission owners system must be ready by July 1, 2006.
- **Dollar conversion from one year to another**
All dollar figures are year end 2003 dollars. Dollar conversion rate from one year to the other has been assumed to be 3.3% per year
- **Substation Equipment Procurement and Construction**
The procurement of substation equipment and construction will start 12 months before the generator in-service date.
- **10% Markup**
A 10% cost markup has been applied to all estimates.
- **Lead time**
Total time necessary to complete the identified task

3. Construction Cost and Schedule

Construction Cost

Task	Cost in 2003 Dollars	Cost in 2007 Dollars
<u>Trimble Co. 345 KV Substation Cost without Take-off Structure</u>	\$3,940,275	\$4,486,708
<u>Cost of the interconnection take off structure at the Trimble 345 KV substation</u>	\$110,000	\$125,255
<u>Line from Trimble 345 KV substation to the new tap on Speed – Ghent 345 KV line</u>	\$3,475,210	\$3,957,149
Material – Cables; steel structures, etc Dead-end structure at the new tap New line from Trimble 345 KV substation to the new tap on Speed – Ghent 345 KV line		
Total	\$7,525,485	\$8,569,112

LG&E Energy Transmission estimates do not include any cost for construction of facilities between the generator and the point of connection at the take-off structure in the Trimble Co. substation.

Cinergy has estimated that \$304,384 (in 2007 dollars) will be required to replace equipment at the Speed 345 KV substation to match the new equipment installed at the Trimble 345 KV substation. LG&E Energy Transmission will relocate the existing protective equipment at Ghent to Trimble Co. as part of this project. Therefore, no significant work will be needed at the Speed 345 KV substation and the Ghent 345 KV substation.

All of the identified facilities must be completed 6 months before the commercial operation date of January 1, 2007 to facilitate testing of the new unit. Therefore, all the transmission work must be finished by July 1, 2006. A schedule of the key tasks are given below -

Start Date	Task/Item
October 1, 2003	Looping of Ghent – Speed 345 KV line through Trimble 345 KV substation – Engineering Design
July 1, 2004	Looping of Ghent – Speed 345 KV line through Trimble 345 KV substation <ul style="list-style-type: none"> • Right of way acquisition
April 1, 2005	Looping of Ghent – Speed 345 KV line through Trimble 345 KV substation <ul style="list-style-type: none"> • New Line Material Acquisition
July 1, 2005	Trimble 345 KV substation <ul style="list-style-type: none"> • Order all substation materials
January 1, 2006	Looping of Ghent – Speed 345 KV line through Trimble 345 KV substation <ul style="list-style-type: none"> • New Line Construction

4. Identification of Costs Eligible for Credits

The total interconnection cost was further analyzed to identify the direct interconnection cost and the system upgrade cost. MISO's definition of direct connect is the radial from the GSU to the substation. Usually breakers in a breaker and a half scheme are considered upgrades. If breaker is direct connect between the GSU and the sub (i.e. radial) it is a direct connect cost to the Generator otherwise in any network flow through configuration it is a system upgrade. The cost of the take-off structure at the Trimble 345 KV substation and the associated work was assigned to the direct interconnection cost. Therefore, the remaining cost of \$8,443,857 in 2007 dollars is eligible for credits to the developer toward the future use of the transmission services. LG&E Energy

Transmission contests the MISO definition. LG&E Energy Transmission considers the take-off structure, one breaker, two disconnects and the associated facilities as part of the cost to connect the Generator. The associated costs for this project is \$745,766 in 2007 dollars.

5. Review and Analysis of Generation Interconnection Evaluation Study

The purpose of this review and analysis is to adequately address all the issues that were identified in the evaluation study and establish that the new facility upgrades will satisfy all pertinent criteria, and will not deteriorate the system.

Prior to proceeding with the facility study, MISO had performed the generation interconnection evaluation study and has published a study report.

Dynamic Stability Analysis – The dynamic stability analysis revealed that the system with the new generator (project G218) installed remained stable when tested with SIS study facility upgrade Options 1, 3, and 4 but unstable for Option 2. The stability analysis also revealed that the looping the Speed – Ghent 345 KV line through the Trimble 345 KV substation was sufficient for the system to remain stable after the addition of TC2 generator. Since the LG&E Energy Transmission chose to proceed with facility upgrade option 4, the system dynamic stability is of no concern.

Short Circuit Analysis – The short circuit analysis revealed that the addition of the new generator TC2 caused an increase in the fault currents seen by a number of breakers in the system. The increased fault currents were within the breaker current interruption capabilities. Therefore, no breaker replacements were needed due to the interconnection of this generator to the system.

The evaluation study revealed that, at OVEC's Clifty Creek 345 kV, duties imposed on at least two circuit breakers were shown to be approaching their nameplate capabilities. Further analysis was performed by AEP to establish that sufficient margin exists at these two breakers after installation of TC unit #2 and the proposed facility upgrades. After additional fault studies (using the model from the Interconnection Evaluation study) and consultation with AEP Station Engineering staff, it has been determined that all of the Clifty Creek 345 kV breaker interrupting capabilities are adequate for the increased duties to be imposed by the Trimble County generator addition and associated transmission reinforcements as presently proposed (Identified as Option 4 in the Interconnection Evaluation study.)

Cascading Outage Analysis – The study revealed that there were no new cascading outages introduced due to the addition of the new generator TC2.

6. Conclusions

The total cost to interconnect the proposed generator to the network has been estimated to be \$8,569,112 in 2007 dollars. All the system upgrades are in the LG&E Energy Transmission system.

The total interconnection cost was further analyzed to identify the direct interconnection cost and the system upgrade cost. MISO's definition of direct connect is the radial from the GSU to the substation. Usually breakers in a breaker and a half scheme are considered upgrades. If breaker is direct connect between the GSU and the sub (i.e. radial) it is a direct connect cost to the Generator otherwise in any network flow through configuration it is a system upgrade. The cost of the take-off structure at the Trimble 345 KV substation and the associated work was assigned to the direct interconnection cost. Therefore, the remaining cost of \$8,443,857 in 2007 dollars is eligible for credits to the developer toward the future use of the transmission services. LG&E Energy Transmission contests the MISO definition. LG&E Energy Transmission considers the take-off structure, one breaker, two disconnects and the associated facilities as part of the cost to connect the Generator. The associated costs for this project is \$745,766 in 2007 dollars.

The study has identified the key events and the schedule for those events in order to achieve a commercial operation date of January 1, 2007. The necessary time for the transmission-line work related to looping the Speed – Ghent 345 KV line through the Trimble 345 KV substation has been identified as one of the longest, and must start around October 1, 2003 in order to meet the deadline. The schedule in the report will need to be updated in the event the in-service date of the proposed generator changes

Generation Interconnection Evaluation
Of a 750 MW Generating Power Plant
At Trimble County, KY

Fault Definition	Fault	Base	Option 1	Option 2	Option 3	Option 4
Faults at Trimble (#27013) 345 KV Station						
3-phase fault at Trimble (#27013) 345/138 KV transformer (#27147); 4 cycle clearing	3P4	S	S	S	S	S
3-phase fault on Trimble (#27013) 345 KV to Clifty (#24952) 345 KV line ckt 1, 4 cycle clearing	3P1	S	S	S	S	S
3-phase fault on Trimble (#27013) 345 KV to Middletown (#27007) 345 KV line ckt 2, 4 cycle clearing	3P2	S	S	S	S	S
3-phase fault on Trimble (#27013) 345 KV to Buchner (#27338) 345 KV line ckt 1, 4 cycle clearing	3P3	S	S	S	S	S
3-phase fault on Trimble (#27013) 345 KV to W. Frankfort (#27014) 345 KV line ckt 01, 4 cycle clearing	3PO1A	N/A	S	N/A	N/A	N/A
3-phase fault on Trimble (#27013) 345 KV to Ghent (#27005) 345 KV line ckt 1, 4 cycle clearing	3POP3A	N/A	N/A	N/A	S	S
3-phase fault on Trimble (#27013) 345 KV to Speed 25386 345 KV line ckt 1, 4 cycle clearing	3POF3B	N/A	N/A	N/A	S	S
Single pole stuck breaker fault on Trimble (#27013) 345 KV to Clifty (#24952) 345 KV line ckt 1, Total fault duration - 17 cycles	SP1	S	S	U	S	S
Single pole stuck breaker fault on Trimble (#27013) 345 KV to Clifty (#24952) 345 KV line ckt 1, Total fault duration - 14.5 cycles	SP1			S		
Single pole stuck breaker fault on Trimble (#27013) 345 KV to Middletown (#27007) 345 KV line ckt 2, Total fault duration - 17 cycles	SP2	S	S	S	S	S
Single pole stuck breaker fault on Trimble (#27013) 345 KV to Buckner (#27338) 345 KV line ckt 1, Total fault duration - 17 cycles	SP3	S	S	S	S	S
Single pole stuck breaker fault on Trimble (#27013) 345 KV to W. Frankfort (#27014) 345 KV line ckt 01, Total fault duration - 17 cycles	SPO1A	N/A	S	N/A	N/A	N/A

Generation Interconnection Evaluation
Of a 750 MW Generating Power Plant
At Trimble County, KY

Single pole stuck breaker fault on Trimble (#27013) 345 KV to Cibant (#27005) 345 KV line ckt 1, Total fault duration - 17 cycles	SPOP3A	N/A	N/A	N/A	S	S
Single pole stuck breaker fault on Trimble (#27013) 345 KV to Speed (#25386) 345 KV line ckt 1, Total fault duration - 17 cycles	SPOP3B	N/A	N/A	N/A	S	S
Single pole stuck breaker fault on Trimble (#27013) 345 KV to Trimble (#25147) 138 KV line ckt 1, Total fault duration - 17 cycles	SP4	S	S	S	S	S
Faults at Clifty (#24952) 345 KV Station						
3-phase fault on Clifty (#24952) 345 KV to Trimble 345 (#27013) 345 KV line ckt 1, 4 cycle clearing	3P5	S	S	S	S	S
3-phase fault on Clifty (#24952) 345 KV to Jefferson (#22667) 765 KV line ckt 1, 4 cycle clearing	3p11	S	S	S	S	S
Single pole stuck breaker fault on Clifty (#24952) 345 KV to 06DEAR (#24956) 345 KV line ckt SP22		S	S	S	S	S
Single pole stuck breaker fault on Clifty (#24952) 345 KV to Trimble 345 (#27013) 345 KV line ckt 1, Total fault duration - 17 cycles	SP5	S	S	S	S	S
Single pole stuck breaker fault on Clifty (#24952) 345 KV to Jefferson 345 (#22667) 765 KV line ckt 1, Total fault duration - 17 cycles	SP11	S	S	S	S	S
Faults at Middletown (#27007) 345 KV Station						
3-phase fault on Middletown (#27007) 345 KV to Trimble (#27013) 345 KV line ckt 1, 4 cycle clearing	3P6	S	S	S	S	S
3-phase fault on Middletown (#27007) 345 KV to Buckner (#27338) 345 KV line ckt 1, 4 cycle clearing	3P9	S	S	S	S	S
Single pole stuck breaker fault on Middletown (#27007) 345 KV to Trimble (#27013) 345 KV line ckt 1, Total fault duration - 17 cycles	SP6	S	S	S	S	S
Single pole stuck breaker fault on Middletown (#27007) 345 KV to Middletown (#27119) 138 KV line ckt 1, Total fault duration - 17 cycles	SP23	S	S	S	S	S

**Generation Interconnection Evaluation
Of a 750 MW Generating Power Plant
At Trimble County, KY**

	SP9	S	S	S	S	S	S	S
Single pole stuck breaker fault on Middletown (#27007) 345 KV to Buchner (#27338) 345 KV line ckt 1, Total fault duration - 17 cycles								
Faults at W. Frankfort (#27014) 345 KV Station								
3-phase fault on W. Frankfort (#27014) 345 KV to Ghent (#27005) 345 KV line ckt 1, 4 cycle clearing	3P12	S	S	S	S	S	S	S
Single pole stuck breaker fault on W. Frankfort (#27014) 345 KV to Brown (#27004) 345 KV line ckt 1, Total fault duration - 17 cycles	SPOP1D	NA	S	S	S	S	S	NA
Single pole stuck breaker fault on W. Frankfort (#27014) 345 KV to Ghent (#27005) 345 KV line ckt 1, Total fault duration - 17 cycles	SP12	S	S	S	S	S	S	S
Single pole stuck breaker fault on W. Frankfort (#27014) 345 KV to Trimble (#27013) 345 KV line ckt 01, Total fault duration - 17 cycles	SPOP1E	NA	S	S	NA	NA	NA	NA
Single pole stuck breaker fault on W. Frankfort (#27014) 345 KV to W. Frankfort (#27151) 138 KV line ckt 1, Total fault duration - 17 cycles	SP24	S	S	S	S	S	S	S
Faults at Brown (#27004) 345 KV Station								
3-phase fault on Brown (#27004) 345 KV to W. Frankfort (#27014) 345 KV line ckt 1, 4 cycle clearing	3POP1B	NA	S	S	S	S	S	NA
3-phase fault on Brown (#27004) 345 KV to Brown (#27064) 138 KV line ckt 1, 4 cycle clearing	3POP1C	NA	S	S	S	S	S	NA
Single pole stuck breaker fault on Brown (#27004) 345 KV to Alcauld (#27002) 345 KV line ckt 1, Total fault duration - 17 cycles	SP25	S	S	S	S	S	S	S
Single pole stuck breaker fault on Brown (#27004) 345 KV to W. Frankfort (#27014) 345 KV line ckt 1, Total fault duration - 17 cycles	SPOP1B	NA	S	S	S	S	S	NA
Single pole stuck breaker fault on Brown (#27004) 345 KV to Brown (#27064) 138 KV line ckt 1, Total fault duration - 17 cycles	SPOP1C	NA	S	S	S	S	S	NA
Faults at Mill Creek (#27008) 345 KV Station								

**Generation Interconnection Evaluation
Of a 750 MW Generating Power Plant
At Trimble County, KY**

3-phase fault on Mill Creek (#27008) 345 KV to Blue Lick (#27003) 345 KV line ckt 1, 4 cycle clearing	3P13	S	S	S	S	S	S	S	S
3-phase fault on Mill Creek (#27008) 345 KV to Harding (#) 345 KV line ckt 1, 4 cycle clearing	3POP2B	NA	NA	NA	NA	NA	NA	NA	NA
Single pole stuck breaker fault on Mill Creek (#27008) 345 KV to Blue Lick (#27003) 345 KV line ckt 1, Total fault duration - 17 cycles	SP13	S	S	S	S	S	S	S	S
Single pole stuck breaker fault on Mill Creek (#27008) 345 KV to Paddy Run (#27010) 345 KV line ckt 1, Total fault duration - 17 cycles	SP26	S	S	S	S	S	S	S	S
Single pole stuck breaker fault on Mill Creek (#27008) 345 KV to Harding (#) 345 KV line ckt 1, Total fault duration - 17 cycles	SPPOP2B	NA	NA	NA	NA	NA	NA	NA	NA
Faults at Harding County (#27006) 345 KV Station									
3-phase fault on Harding County (#27006) 345 KV to Harding (#27100) 138 KV line ckt 1, 4 cycle clearing	3P14	S	S	S	S	S	S	S	S
Single pole stuck breaker fault on Harding County (#27006) 345 KV to Smith (#27012) 345 KV line ckt 1, Total fault duration - 17 cycles	SP28	S	S	S	S	S	S	S	S
Single pole stuck breaker fault on Harding County (#27006) 345 KV to Harding (#27100) 138 KV line ckt 1, Total fault duration - 17 cycles	SP14	S	S	S	S	S	S	S	S
Faults at Ghent (#27005) 345 KV Station									
3-phase fault on Ghent (#27005) 345 KV to W. Frankfort (#27014) 345 KV line ckt 1, 4 cycle clearing	3P15	S	S	S	S	S	S	S	S
3-phase fault on Ghent (#27005) 345 KV to W. Lexington (#27015) 345 KV line ckt 1, 4 cycle clearing	3P16	S	S	S	S	S	S	S	S
Single pole stuck breaker fault on Ghent (#27005) 345 KV to Speed (#25386) 345 KV line ckt 1, Total fault duration - 17 cycles	SP31	U	S	S	S	S	S	NA	NA
Single pole stuck breaker fault on Ghent (#27005) 345 KV to Batesville (#25387) 345 KV line ckt 1, Total fault duration - 17 cycles	SP29	U	S	S	S	S	S	S	S

G218 STUDY
STUDY CASE WITH OPT.2 UPGRADES

FILE: G218_OP2_SPL.OUT
CHRG 14: [ANAL 2700] [LIMIT CHG48.00] [2]

150.00	CHRG 14: [ANAL 2700] [LIMIT CHG48.00] [2]	-50.00
150.00	CHRG 15: [ANAL 2700] [LIMIT CHG48.00] [2]	-50.00
150.00	CHRG 16: [ANAL 2700] [LIMIT CHG48.00] [1]	-50.00
150.00	CHRG 17: [ANAL 2700] [LIMIT CHG48.00] [4]	-50.00
150.00	CHRG 18: [ANAL 2700] [LIMIT CHG48.00] [2]	-50.00
150.00	CHRG 19: [ANAL 2700] [LIMIT CHG48.00] [2]	-50.00

THU, FEB 20 2003 14:33
LSEE

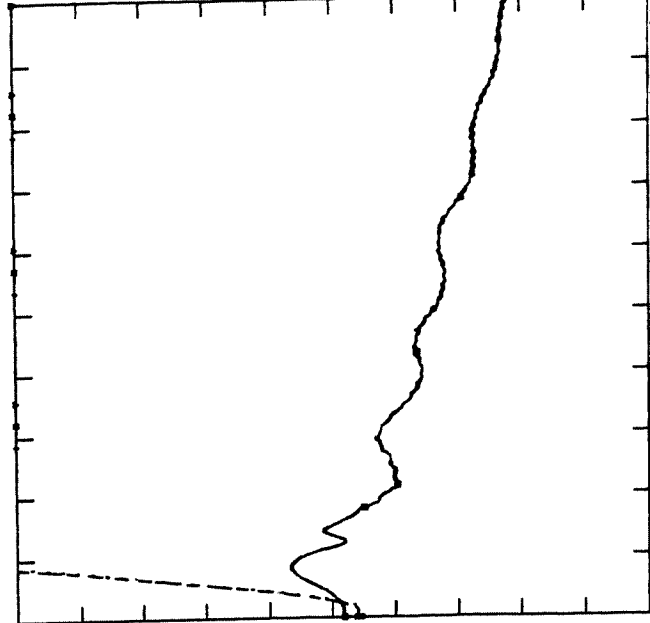

G218 STUDY
STUDY CASE WITH OPT.2 UPGRADES

FILE: G218_OP2_SPL.OUT
CHRG 20: [ANAL 2700] [LIMIT CHG48.00] [1]

150.00	CHRG 20: [ANAL 2700] [LIMIT CHG48.00] [1]	-50.00
150.00	CHRG 21: [ANAL 2700] [LIMIT CHG48.00] [1]	-50.00
150.00	CHRG 22: [ANAL 2700] [LIMIT CHG48.00] [1]	-50.00
150.00	CHRG 23: [ANAL 2700] [LIMIT CHG48.00] [2]	-50.00
150.00	CHRG 24: [ANAL 2700] [LIMIT CHG48.00] [2]	-50.00
150.00	CHRG 25: [ANAL 2700] [LIMIT CHG48.00] [7]	-50.00

THU, FEB 20 2003 14:33
LSEE

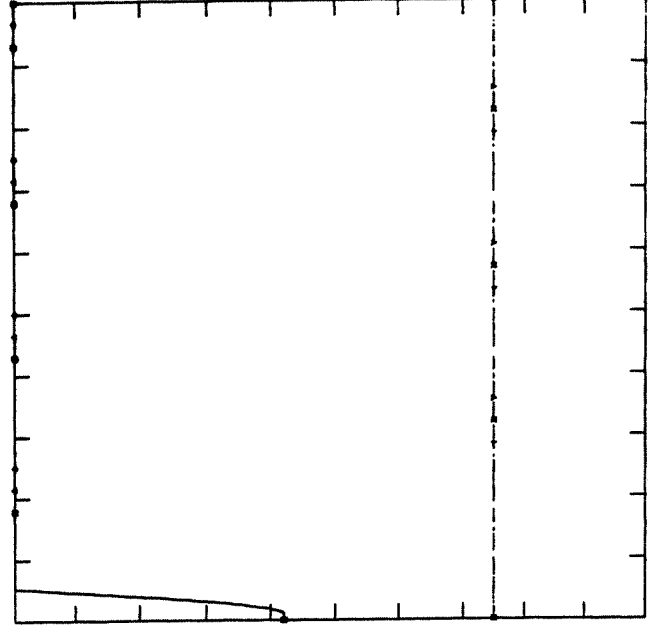

G218 STUDY
STUDY CASE WITH OPT.2 UPGRADES

FILE: G218_OP2_SPL.OUT

1.1000	CHRG 2: [VOLT 18127 (DI RPT 20.700)]	0.00000
150.00	CHRG 3: [ANAL 18127 (DI RPT 20.700)] [1]	-50.00

THU, FEB 20 2003 14:33
SWING BUS

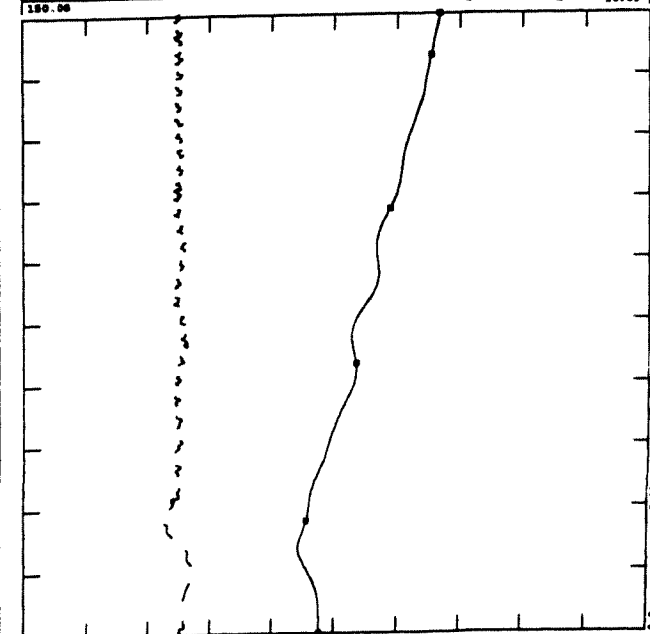

G218 STUDY
STUDY CASE WITH OPT.2 UPGRADES

FILE: G218_OP2_SPL.OUT
CHRG 26: [ANAL 2700] [LIMIT CHG48.00] [1]

150.00	CHRG 26: [ANAL 2700] [LIMIT CHG48.00] [1]	-50.00
150.00	CHRG 27: [ANAL 2700] [LIMIT CHG48.00] [1]	-50.00
150.00	CHRG 28: [ANAL 2700] [LIMIT CHG48.00] [2]	-50.00
150.00	CHRG 29: [ANAL 2700] [LIMIT CHG48.00] [1]	-50.00
150.00	CHRG 30: [ANAL 2700] [LIMIT CHG48.00] [1]	-50.00
150.00	CHRG 31: [ANAL 2700] [LIMIT CHG48.00] [4]	-50.00

THU, FEB 20 2003 14:33
LSEE

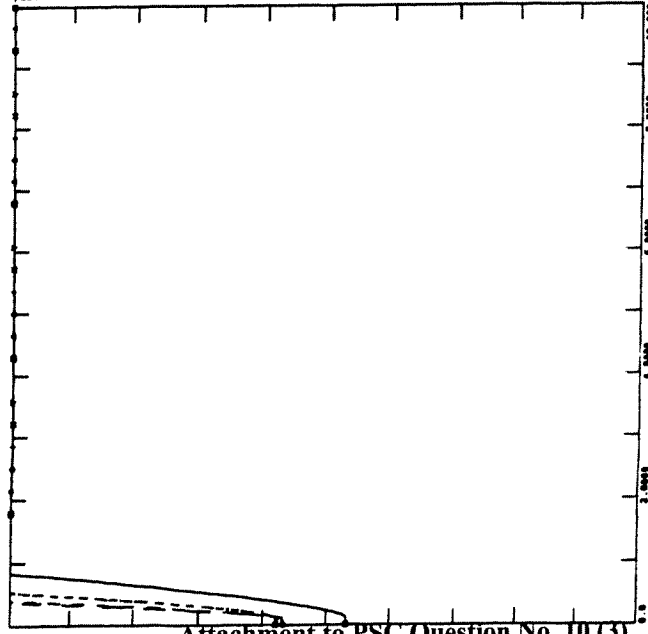

Attachment to PSC Question No. 10 (3)

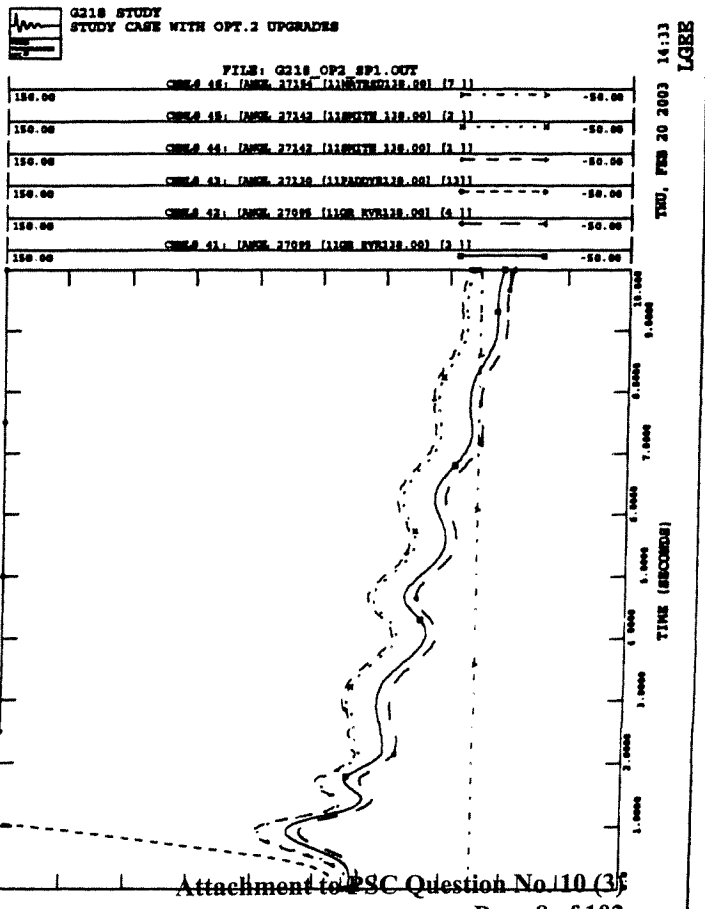
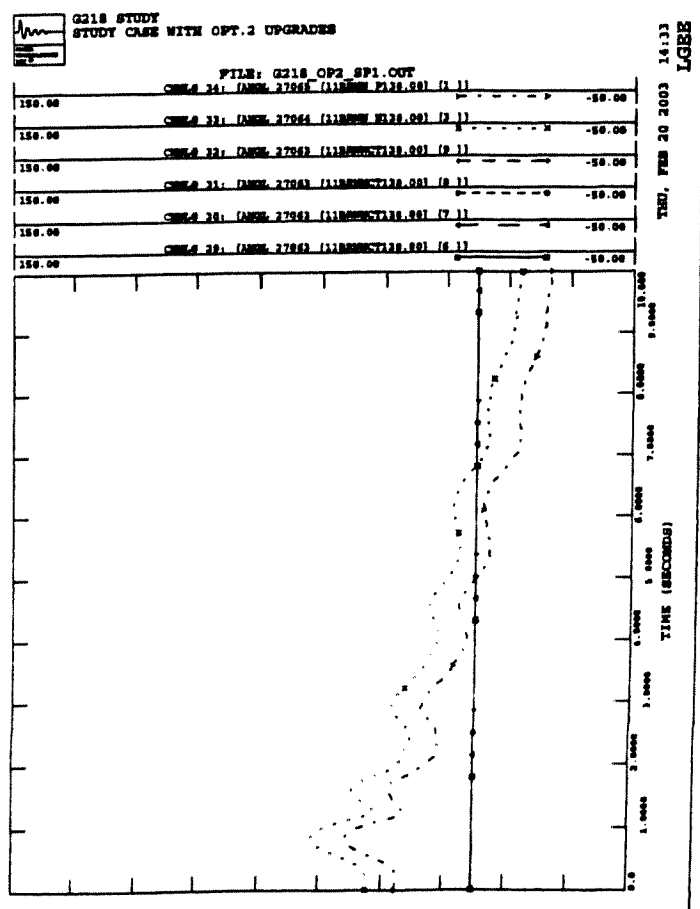
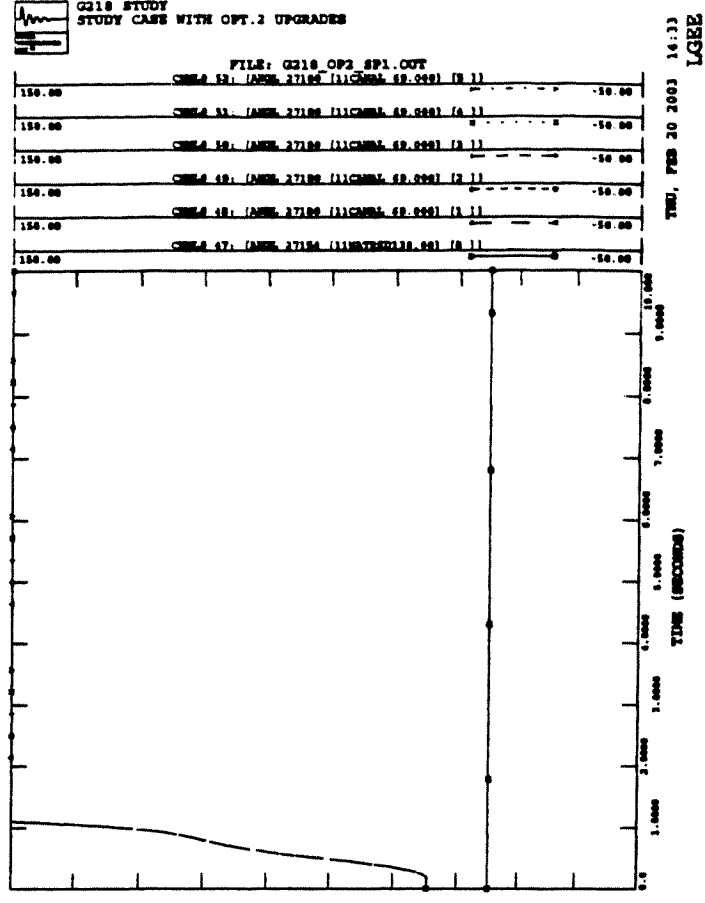
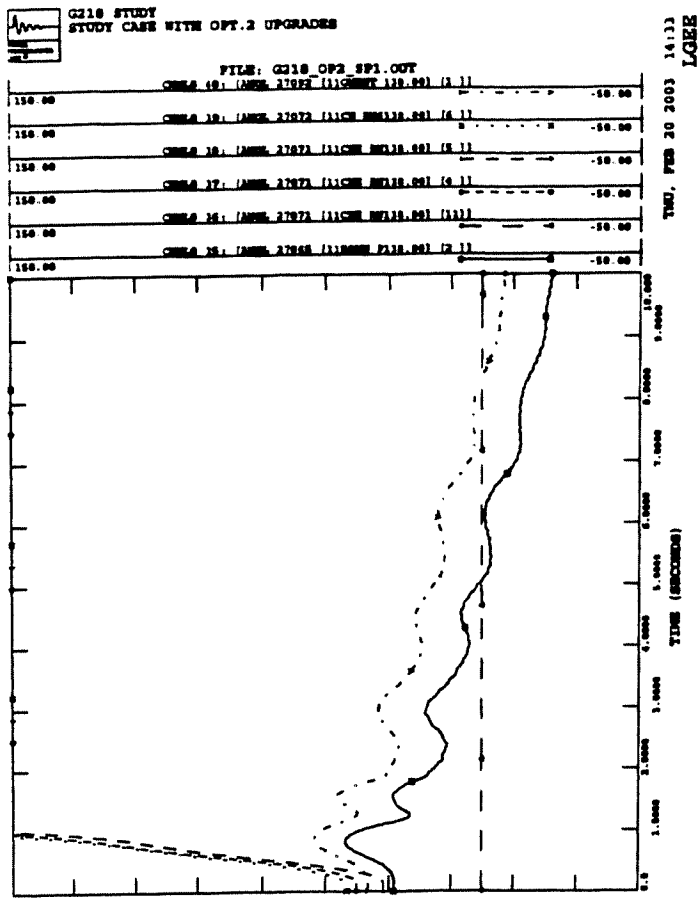



G218 STUDY
STUDY CASE WITH OPT.2 UPGRADES

FILE: G218_OP2_S01.OUT

150.00	CHEG 61: [ANGL 27217 (11)KCHTMLR.000] (1 1)	-50.00
150.00	CHEG 62: [ANGL 27220 (11)KCHTMLR.000] (2 1)	-50.00
150.00	CHEG 63: [ANGL 27220 (11)KCHTMLR.000] (2 1)	-50.00
150.00	CHEG 64: [ANGL 27220 (11)KCHTMLR.000] (1 1)	-50.00
150.00	CHEG 65: [ANGL 27218 (11)GR KVMSR.000] (2 1)	-50.00
150.00	CHEG 66: [ANGL 27218 (11)GR KVMSR.000] (1 1)	-50.00

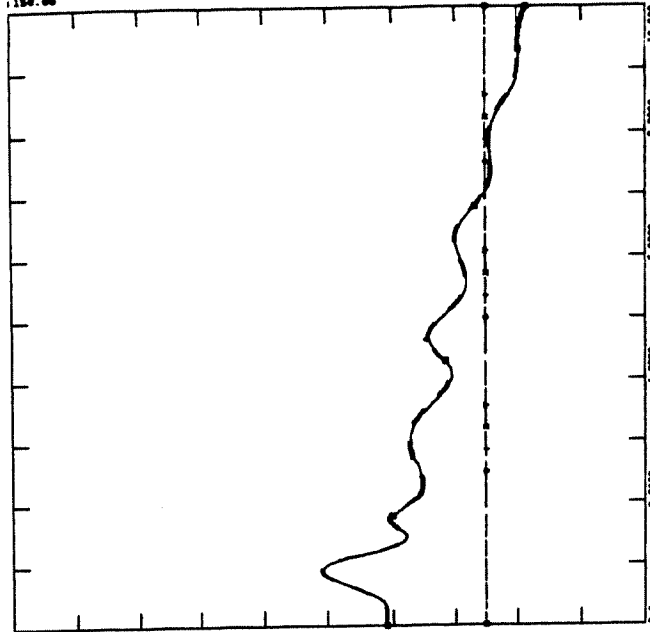

G218 STUDY
STUDY CASE WITH OPT.2 UPGRADES

FILE: G218_OP2_S01.OUT

150.00	CHEG 71: [ANGL 27218 (11)KCHTMLR.000] (2 1)	-50.00
150.00	CHEG 72: [ANGL 27220 (11)KCHTMLR.000] (2 1)	-50.00
150.00	CHEG 73: [ANGL 27220 (11)KCHTMLR.000] (1 1)	-50.00

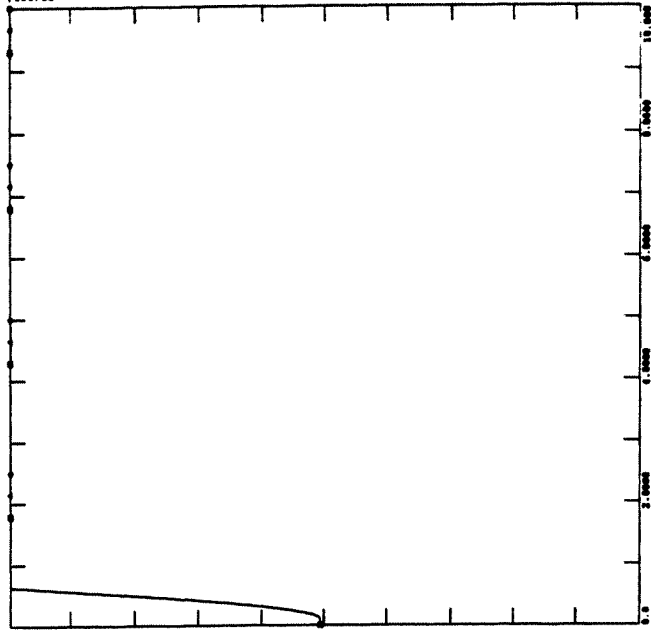

G218 STUDY
STUDY CASE WITH OPT.2 UPGRADES

FILE: G218_OP2_S01.OUT

150.00	CHEG 68: [ANGL 27120 (11)KCHTMLR.000] (2 1)	-50.00
150.00	CHEG 67: [ANGL 27120 (11)KCHTMLR.000] (2 1)	-50.00
150.00	CHEG 66: [ANGL 27120 (11)KCHTMLR.000] (1 1)	-50.00
150.00	CHEG 65: [ANGL 27120 (11)KCHTMLR.000] (2 1)	-50.00
150.00	CHEG 64: [ANGL 27120 (11)KCHTMLR.000] (1 1)	-50.00
150.00	CHEG 63: [ANGL 27120 (11)KCHTMLR.000] (2 1)	-50.00
150.00	CHEG 62: [ANGL 27120 (11)KCHTMLR.000] (1 1)	-50.00

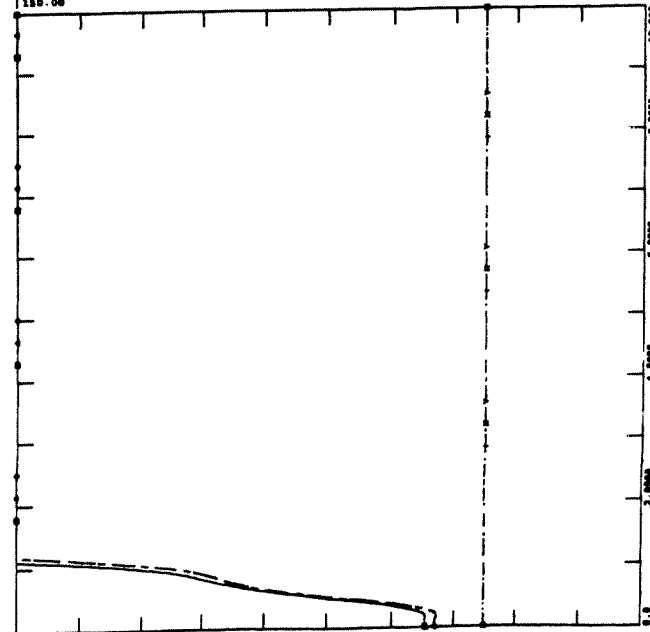

G218 STUDY
STUDY CASE WITH OPT.2 UPGRADES

FILE: G218_OP2_S01.OUT

150.00	CHEG 78: [ANGL 27218 (11)KCHTMLR.000] (2 1)	-50.00
150.00	CHEG 69: [ANGL 27212 (11)KCHTMLR.000] (1 1)	-50.00
150.00	CHEG 68: [ANGL 27220 (11)KCHTMLR.000] (2 1)	-50.00
150.00	CHEG 67: [ANGL 27220 (11)KCHTMLR.000] (2 1)	-50.00
150.00	CHEG 66: [ANGL 27220 (11)KCHTMLR.000] (1 1)	-50.00
150.00	CHEG 65: [ANGL 27220 (11)KCHTMLR.000] (2 1)	-50.00
150.00	CHEG 64: [ANGL 27220 (11)KCHTMLR.000] (1 1)	-50.00

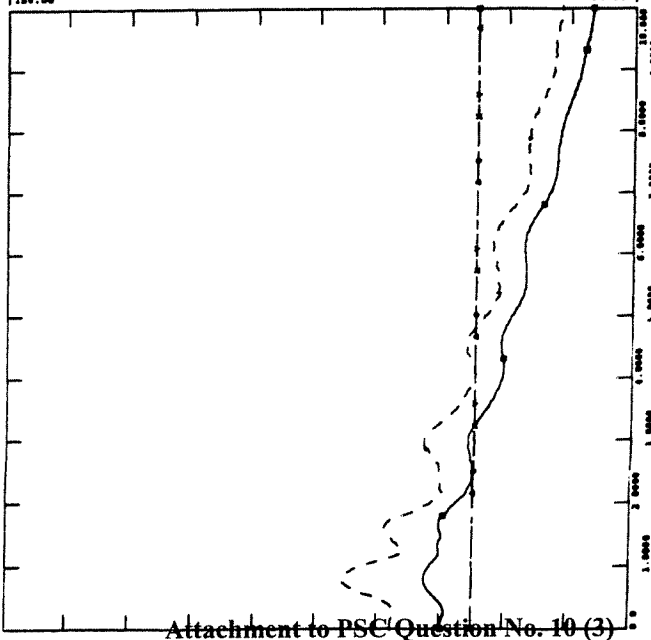

Attachment to PSC Question No. 10 (3)



G218 STUDY
STUDY CASE WITH OPT.2 UPGRADES

FILE: G218_OP2_S91.OUT
CHNL 69: (VOLT 27162 (1118070118.001))

1.1000	CHNL 64: (VOLT 27138 (1118070118.001))	0.50000
1.1000	CHNL 61: (VOLT 27138 (1118070118.001))	0.50000
1.1000	CHNL 61: (VOLT 27138 (1118070118.001))	0.50000
1.1000	CHNL 61: (VOLT 27138 (1118070118.001))	0.50000
1.1000	CHNL 61: (VOLT 27138 (1118070118.001))	0.50000
1.1000	CHNL 61: (VOLT 27138 (1118070118.001))	0.50000
1.1000	CHNL 61: (VOLT 27138 (1118070118.001))	0.50000

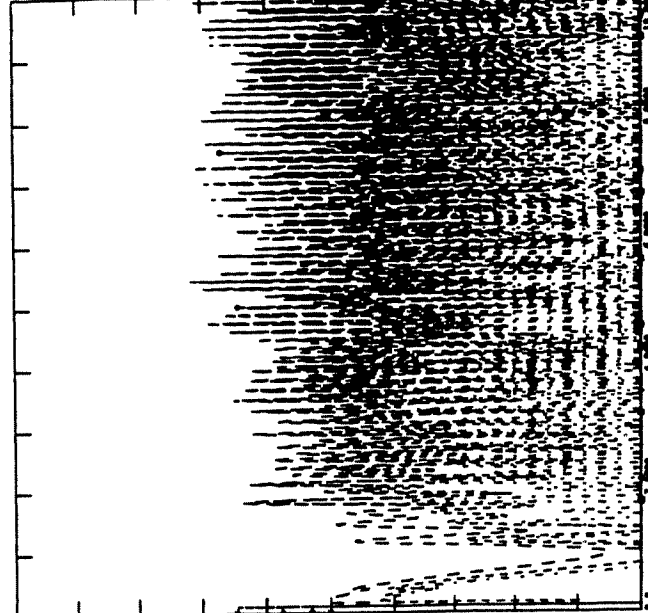

THU, FEB 20 2003 14:33
LGE2



G218 STUDY
STUDY CASE WITH OPT.2 UPGRADES

FILE: G218_OP2_S91.OUT

1.1000	CHNL 64: (VOLT 27138 (1118070118.001))	0.50000
1.1000	CHNL 62: (VOLT 27216 (1118070118.001))	0.50000
1.1000	CHNL 64: (VOLT 27138 (1118070118.001))	0.50000
1.1000	CHNL 61: (VOLT 27138 (1118070118.001))	0.50000
1.1000	CHNL 61: (VOLT 27138 (1118070118.001))	0.50000
1.1000	CHNL 61: (VOLT 27138 (1118070118.001))	0.50000
1.1000	CHNL 61: (VOLT 27138 (1118070118.001))	0.50000

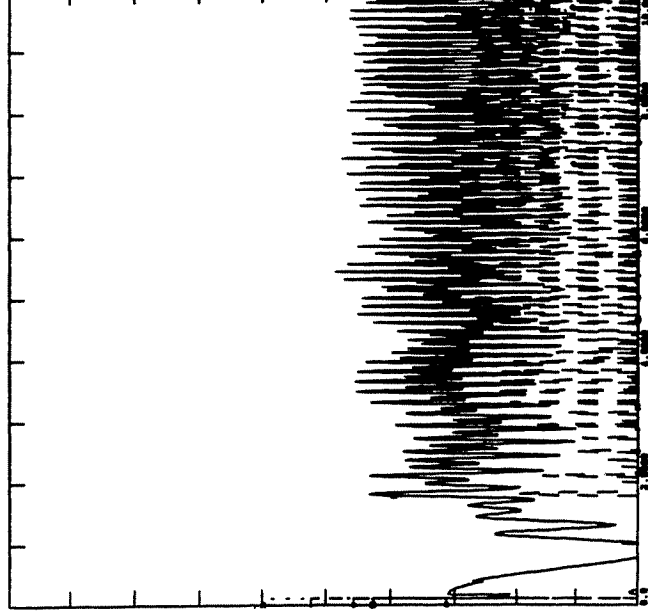

THU, FEB 20 2003 14:33
LGE2



G218 STUDY
STUDY CASE WITH OPT.2 UPGRADES

FILE: G218_OP2_S91.OUT
CHNL 71: (VOLT 27658 (1118070118.001))

1.1000	CHNL 71: (VOLT 27654 (1118070118.001))	0.50000
1.1000	CHNL 77: (VOLT 27653 (1118070118.001))	0.50000
1.1000	CHNL 74: (VOLT 27613 (1118070118.001))	0.50000
1.1000	CHNL 75: (VOLT 27608 (1118070118.001))	0.50000
1.1000	CHNL 74: (VOLT 27608 (1118070118.001))	0.50000
1.1000	CHNL 74: (VOLT 27608 (1118070118.001))	0.50000
1.1000	CHNL 74: (VOLT 27608 (1118070118.001))	0.50000

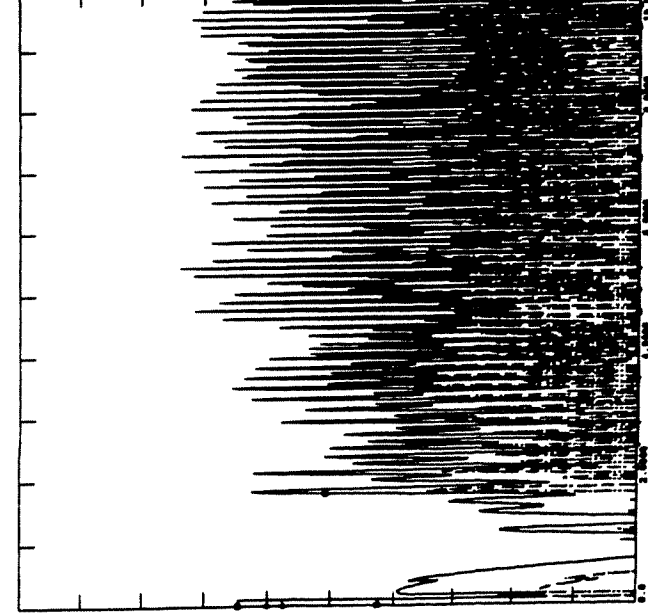

THU, FEB 20 2003 14:33
LGE2



G218 STUDY
STUDY CASE WITH OPT.2 UPGRADES

FILE: G218_OP2_S91.OUT

1.1000	CHNL 61: (VOLT 27217 (1118070118.001))	0.50000
1.1000	CHNL 62: (VOLT 27220 (1118070118.001))	0.50000
1.1000	CHNL 62: (VOLT 27216 (1118070118.001))	0.50000
1.1000	CHNL 62: (VOLT 27138 (1118070118.001))	0.50000
1.1000	CHNL 67: (VOLT 27138 (1118070118.001))	0.50000
1.1000	CHNL 64: (VOLT 27134 (1118070118.001))	0.50000
1.1000	CHNL 64: (VOLT 27134 (1118070118.001))	0.50000

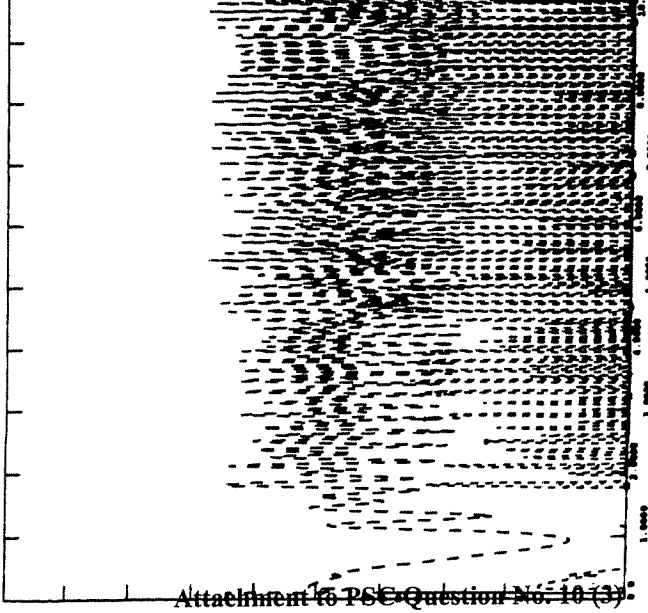

THU, FEB 20 2003 14:33
LGE2



G218 STUDY
STUDY CASE WITH OPT.2 UPGRADES

FILE: G218_OP2_S91.OUT

150.00	CHRG 118: [ANAL 26242 [OBSERD 2112.000] [03]]	-50.00
150.00	CHRG 117: [ANAL 26242 [OBSERD 2112.000] [03]]	-50.00
150.00	CHRG 116: [ANAL 26242 [OBSERD 2112.000] [03]]	-50.00
150.00	CHRG 115: [ANAL 26242 [OBSERD 2112.000] [03]]	-50.00
150.00	CHRG 114: [ANAL 26242 [OBSERD 2112.000] [03]]	-50.00
150.00	CHRG 113: [ANAL 26242 [OBSERD 2112.000] [03]]	-50.00

THU, FEB 20 2003 14:33
CIN

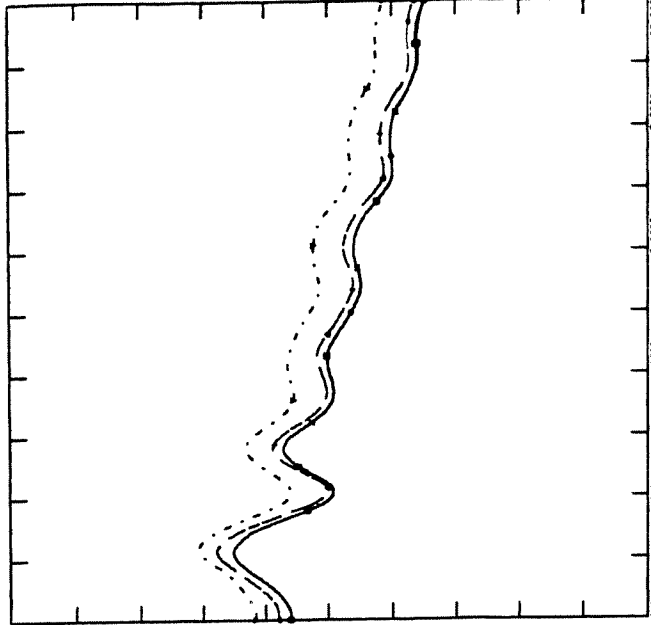

G218 STUDY
STUDY CASE WITH OPT.2 UPGRADES

FILE: G218_OP2_S91.OUT

150.00	CHRG 121: [ANAL 26232 [OBSERD 22.000] [03]]	-50.00
150.00	CHRG 120: [ANAL 26232 [OBSERD 22.000] [03]]	-50.00
150.00	CHRG 119: [ANAL 26232 [OBSERD 22.000] [03]]	-50.00

THU, FEB 20 2003 14:33
CIN

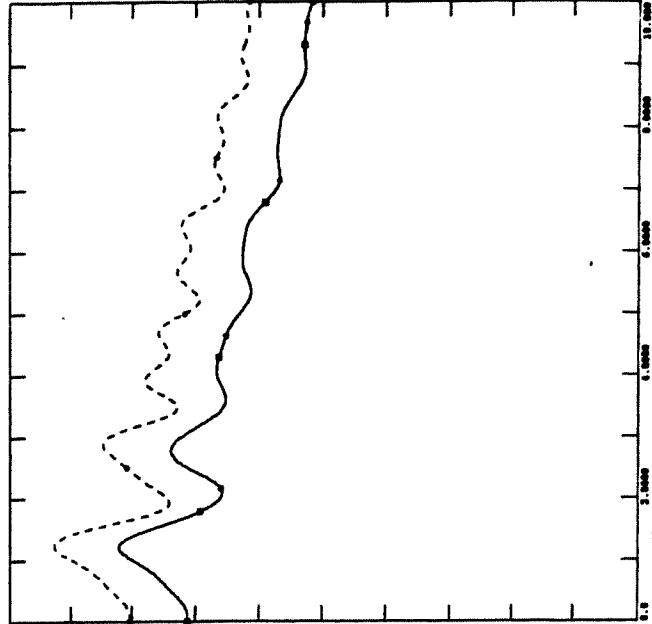

G218 STUDY
STUDY CASE WITH OPT.2 UPGRADES

FILE: G218_OP2_S91.OUT

150.00	CHRG 106: [ANAL 28217 [OBSERD 24.000] [03]]	-50.00
150.00	CHRG 105: [ANAL 28218 [OBSERD 24.000] [03]]	-50.00
150.00	CHRG 104: [ANAL 28217 [OBSERD 24.000] [03]]	-50.00
150.00	CHRG 103: [ANAL 28218 [OBSERD 24.000] [03]]	-50.00
150.00	CHRG 102: [ANAL 28218 [OBSERD 24.000] [03]]	-50.00
150.00	CHRG 101: [ANAL 28214 [OBSERD 24.000] [03]]	-50.00

THU, FEB 20 2003 14:33
CIN

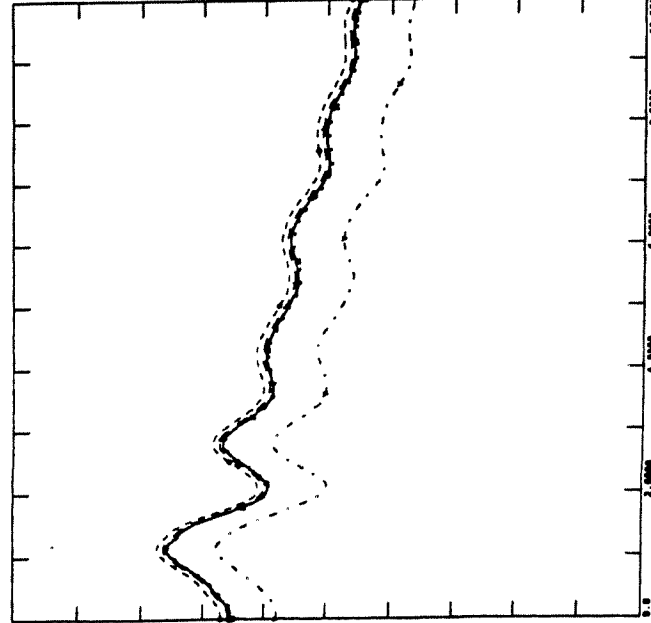

G218 STUDY
STUDY CASE WITH OPT.2 UPGRADES

FILE: G218_OP2_S91.OUT

150.00	CHRG 118: [ANAL 27022 [OBSERD 222.000] [03]]	-50.00
150.00	CHRG 117: [ANAL 27022 [OBSERD 222.000] [03]]	-50.00
150.00	CHRG 116: [ANAL 27022 [OBSERD 222.000] [03]]	-50.00
150.00	CHRG 115: [ANAL 27024 [OBSERD 222.000] [03]]	-50.00
150.00	CHRG 114: [ANAL 27022 [OBSERD 222.000] [03]]	-50.00
150.00	CHRG 113: [ANAL 27022 [OBSERD 222.000] [03]]	-50.00

THU, FEB 20 2003 14:33
CIN

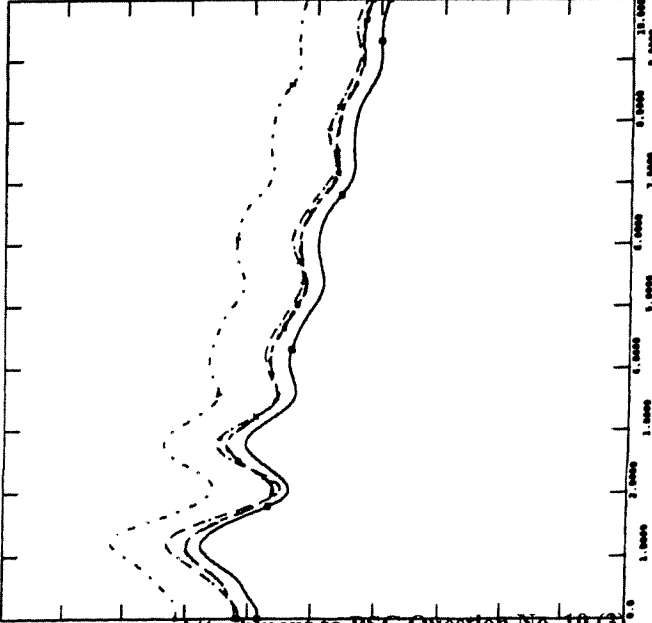



G218 STUDY
STUDY CASE WITH OPT.2 UPGRADES

FILE: G218_OP2_SP1.OUT

1.1000	CHNL 112: [VOLT 27842 [GAINED 2112.000]]	0.90000
1.1000	CHNL 112: [VOLT 26242 [GAINED 2112.000]]	0.90000
1.1000	CHNL 112: [VOLT 26241 [GAINED 2112.000]]	0.90000
1.1000	CHNL 112: [VOLT 26240 [GAINED 2112.000]]	0.90000
1.1000	CHNL 112: [VOLT 26239 [GAINED 2112.000]]	0.90000
1.1000	CHNL 112: [VOLT 26238 [GAINED 2112.000]]	0.90000

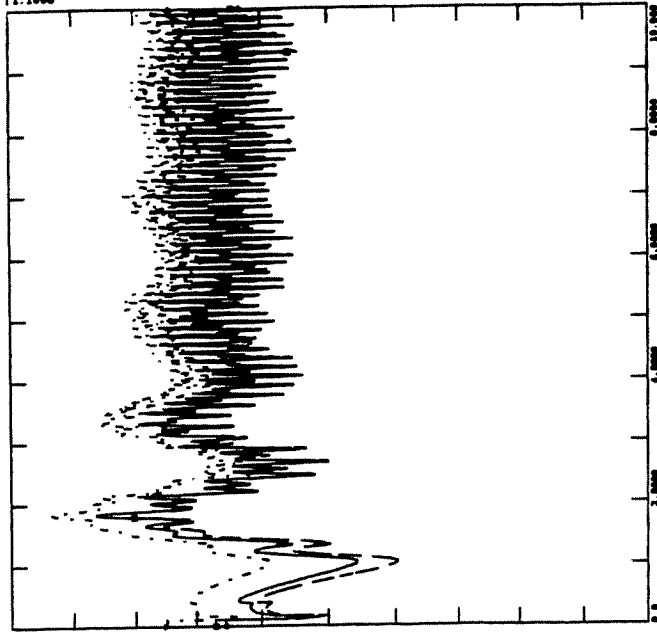

14:33
CIN



G218 STUDY
STUDY CASE WITH OPT.2 UPGRADES

FILE: G218_OP2_SP1.OUT

1.1000	CHNL 112: [VOLT 26218 [GAIN 22.000]]	0.90000
1.1000	CHNL 112: [VOLT 26218 [GAIN 18.000]]	0.90000
1.1000	CHNL 112: [VOLT 26217 [GAIN 18.000]]	0.90000

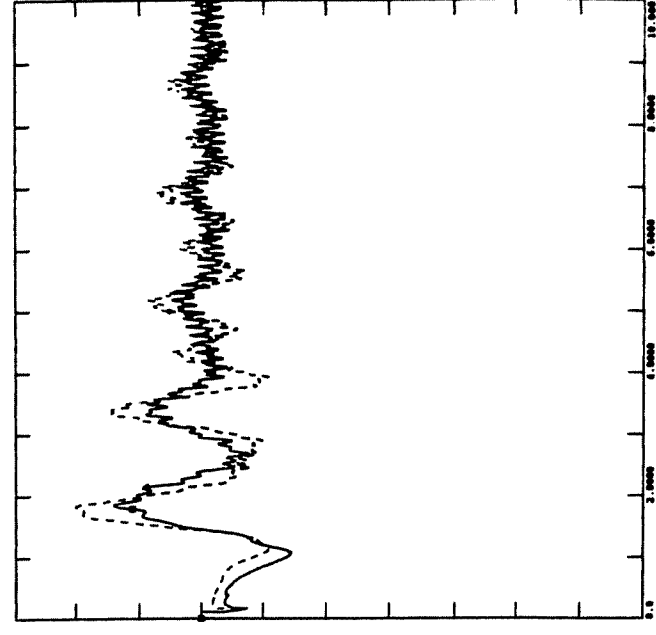

14:33
CIN



G218 STUDY
STUDY CASE WITH OPT.2 UPGRADES

FILE: G218_OP2_SP1.OUT

1.1000	CHNL 127: [VOLT 28227 [GAINED 24.000]]	0.90000
1.1000	CHNL 128: [VOLT 28228 [GAINED 24.000]]	0.90000
1.1000	CHNL 128: [VOLT 28227 [GAINED 24.000]]	0.90000
1.1000	CHNL 126: [VOLT 28226 [GAINED 24.000]]	0.90000
1.1000	CHNL 128: [VOLT 28228 [GAINED 24.000]]	0.90000
1.1000	CHNL 128: [VOLT 28224 [GAINED 24.000]]	0.90000

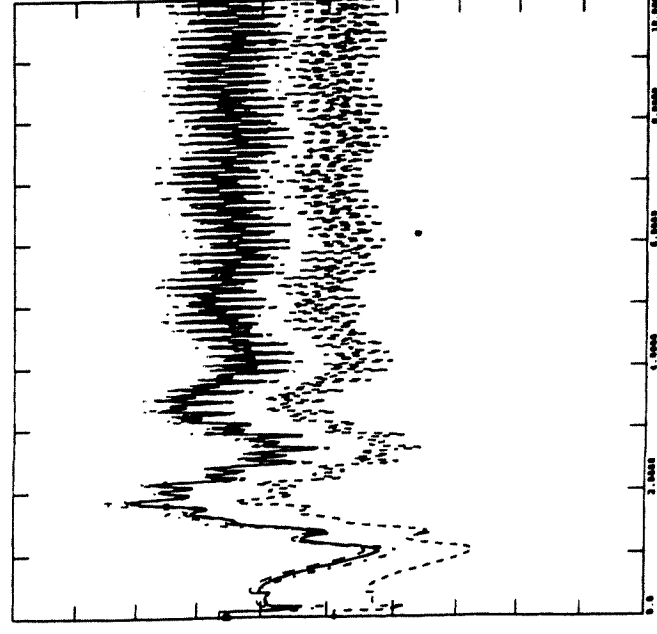

14:33
CIN



G218 STUDY
STUDY CASE WITH OPT.2 UPGRADES

FILE: G218_OP2_SP1.OUT

1.1000	CHNL 118: [VOLT 27216 [GAIN 18.000]]	0.90000
1.1000	CHNL 118: [VOLT 27202 [GAINED 24.000]]	0.90000
1.1000	CHNL 117: [VOLT 27201 [GAINED 24.000]]	0.90000
1.1000	CHNL 116: [VOLT 27264 [GAINED 422.000]]	0.90000
1.1000	CHNL 118: [VOLT 27262 [GAINED 222.000]]	0.90000
1.1000	CHNL 114: [VOLT 27262 [GAINED 222.000]]	0.90000

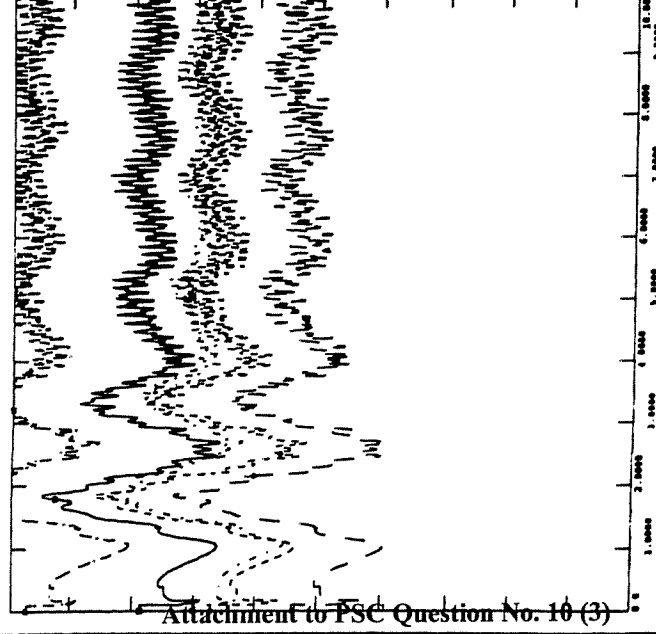

14:33
CIN

G218 STUDY
STUDY CASE WITH OPT.2 UPGRADES

FILE: G218_OP2_SFI.OUT

150.00	CHRG 316: [ANAL 24992] [06C1PTT248.00] [8 11]	-50.00
150.00	CHRG 317: [ANAL 24992] [06C1PTT248.00] [7 11]	-50.00
150.00	CHRG 318: [ANAL 24992] [06C1PTT248.00] [8 11]	-50.00
150.00	CHRG 319: [ANAL 24992] [06C1PTT248.00] [8 11]	-50.00
150.00	CHRG 320: [ANAL 24992] [06C1PTT248.00] [4 11]	-50.00
150.00	CHRG 321: [ANAL 24992] [06C1PTT248.00] [8 11]	-50.00
150.00	CHRG 322: [ANAL 24992] [06C1PTT248.00] [8 11]	-50.00

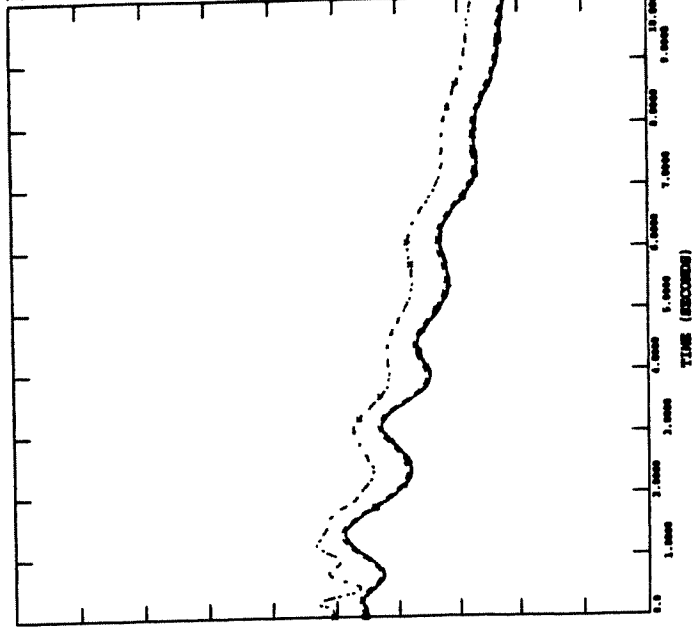

14.33
OVEC

THU, FEB 20 2003

G218 STUDY
STUDY CASE WITH OPT.2 UPGRADES

FILE: G218_OP2_SFI.OUT

150.00	CHRG 323: [ANAL 24992] [06C1PTT248.00] [8 11]	-50.00
150.00	CHRG 324: [ANAL 24992] [06C1PTT248.00] [8 11]	-50.00
150.00	CHRG 325: [ANAL 24992] [06C1PTT248.00] [8 11]	-50.00
150.00	CHRG 326: [ANAL 24992] [06C1PTT248.00] [8 11]	-50.00
150.00	CHRG 327: [ANAL 24992] [06C1PTT248.00] [8 11]	-50.00
150.00	CHRG 328: [ANAL 24992] [06C1PTT248.00] [8 11]	-50.00
150.00	CHRG 329: [ANAL 24992] [06C1PTT248.00] [8 11]	-50.00

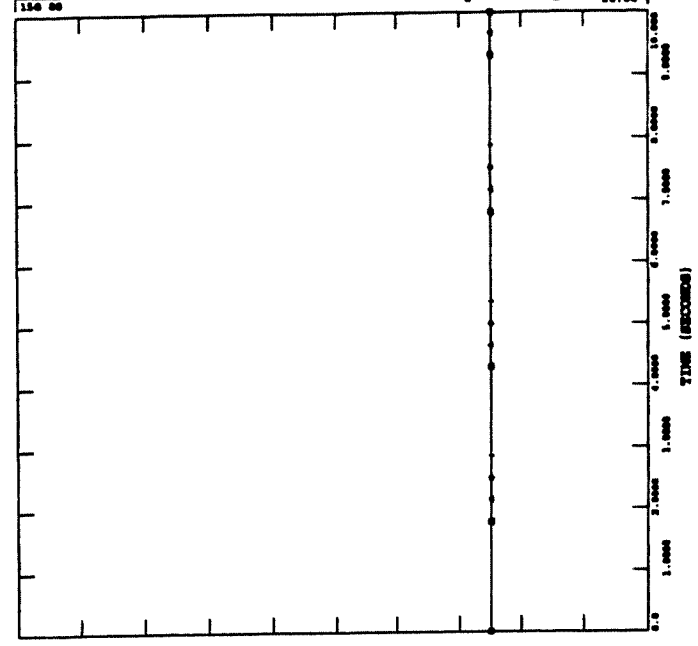

14.33
OVEC

THU, FEB 20 2003

G218 STUDY
STUDY CASE WITH OPT.2 UPGRADES

FILE: G218_OP2_SFI.OUT

150.00	CHRG 312: [ANAL 24992] [06C1PTT248.00] [8 11]	-50.00
150.00	CHRG 313: [ANAL 24992] [06C1PTT248.00] [1 11]	-50.00
150.00	CHRG 314: [ANAL 24992] [06C1PTT248.00] [8 11]	-50.00
150.00	CHRG 315: [ANAL 24992] [06C1PTT248.00] [8 11]	-50.00
150.00	CHRG 316: [ANAL 24992] [06C1PTT248.00] [8 11]	-50.00
150.00	CHRG 317: [ANAL 24992] [06C1PTT248.00] [8 11]	-50.00
150.00	CHRG 318: [ANAL 24992] [06C1PTT248.00] [8 11]	-50.00
150.00	CHRG 319: [ANAL 24992] [06C1PTT248.00] [7 11]	-50.00

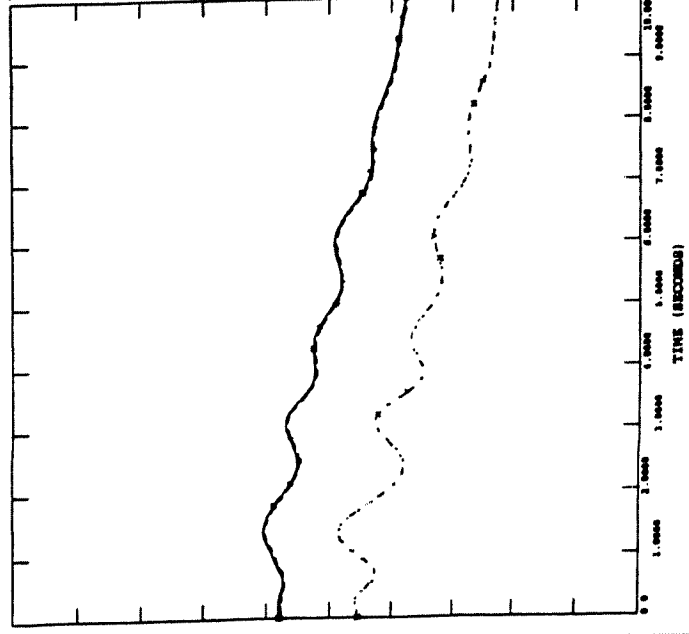

14.33
OVEC

THU, FEB 20 2003

G218 STUDY
STUDY CASE WITH OPT.2 UPGRADES

FILE: G218_OP2_SFI.OUT

150.00	CHRG 324: [ANAL 24992] [06C1PTT248.00] [8 11]	-50.00
150.00	CHRG 325: [ANAL 24992] [06C1PTT248.00] [8 11]	-50.00
150.00	CHRG 326: [ANAL 24992] [06C1PTT248.00] [8 11]	-50.00
150.00	CHRG 327: [ANAL 24992] [06C1PTT248.00] [8 11]	-50.00
150.00	CHRG 328: [ANAL 24992] [06C1PTT248.00] [8 11]	-50.00
150.00	CHRG 329: [ANAL 24992] [06C1PTT248.00] [8 11]	-50.00
150.00	CHRG 330: [ANAL 24992] [06C1PTT248.00] [8 11]	-50.00
150.00	CHRG 331: [ANAL 24992] [06C1PTT248.00] [8 11]	-50.00

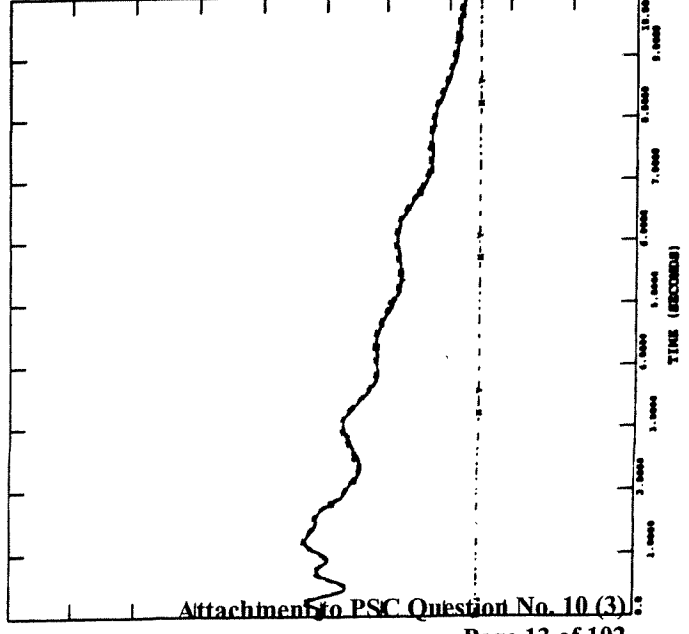

14.33
OVEC

THU, FEB 20 2003

Attachment to PSC Question No. 10 (3)

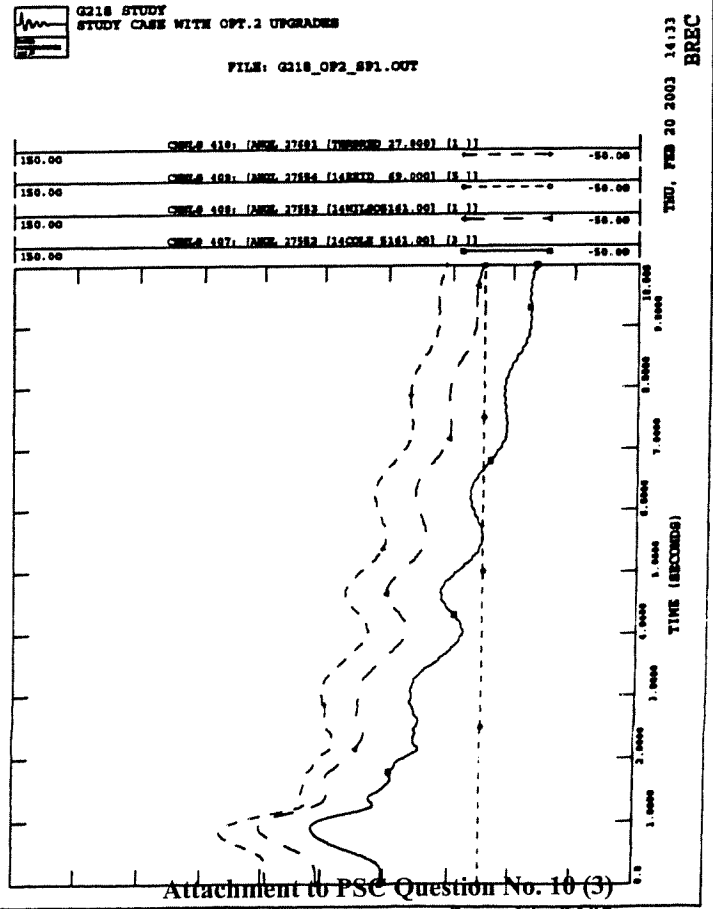
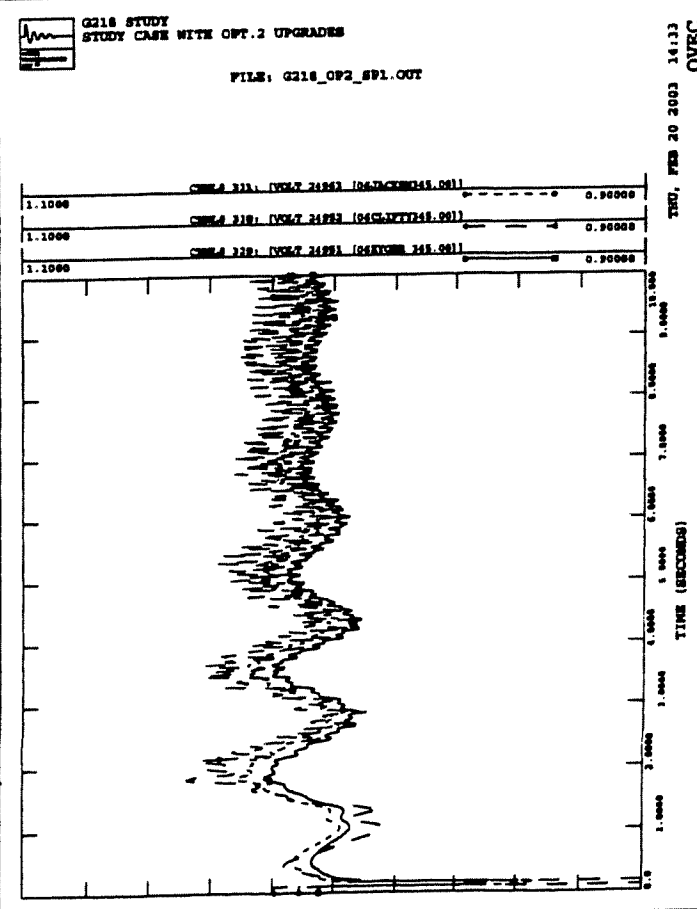
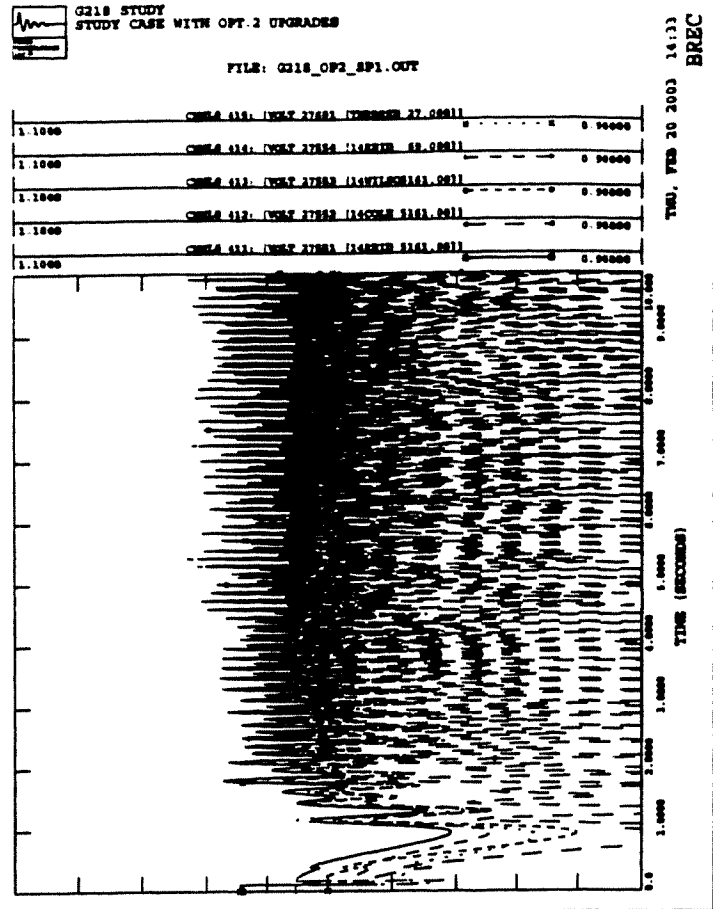
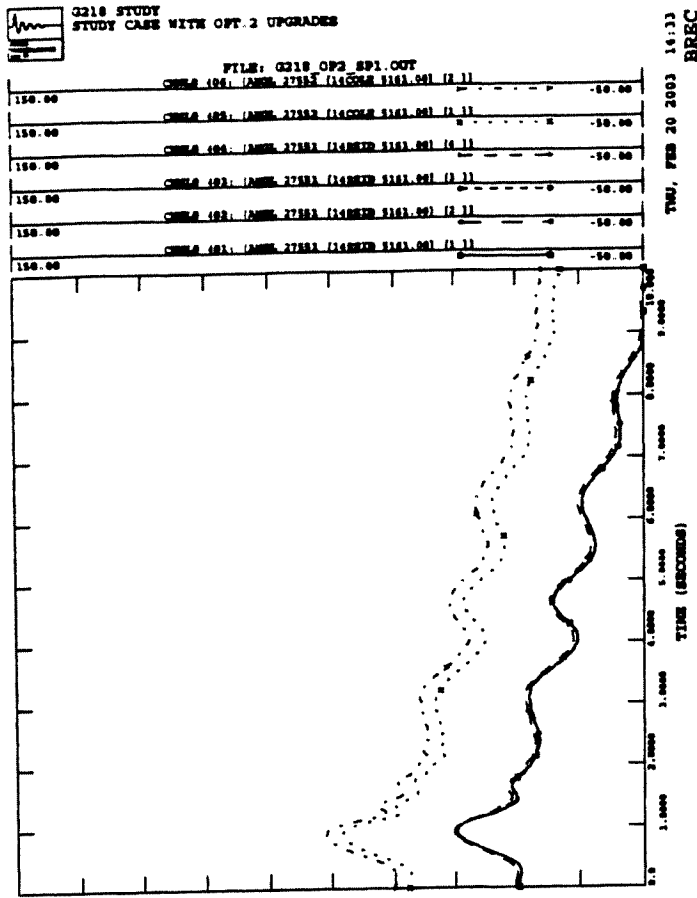

G218 STUDY
STUDY CASE WITH OPT.2 UPGRADES

FILE: G218 CCT9.OUT

150.00	CHEG 18: (ANAL 27800 (11)MTR C2148.00) (2 1)	-50.00
150.00	CHEG 19: (ANAL 27800 (11)MTR C2148.00) (2 1)	-50.00
150.00	CHEG 20: (ANAL 27800 (11)MTR C2148.00) (2 1)	-50.00
150.00	CHEG 21: (ANAL 27800 (11)MTR 248.00) (4 1)	-50.00
150.00	CHEG 22: (ANAL 27800 (11)MTR 248.00) (2 1)	-50.00
150.00	CHEG 23: (ANAL 27800 (11)MTR 248.00) (2 1)	-50.00
150.00	CHEG 24: (ANAL 27800 (11)MTR 248.00) (2 1)	-50.00
150.00	CHEG 25: (ANAL 27800 (11)MTR 248.00) (2 1)	-50.00

TUE, FEB 25 2003 17:19
LJEE

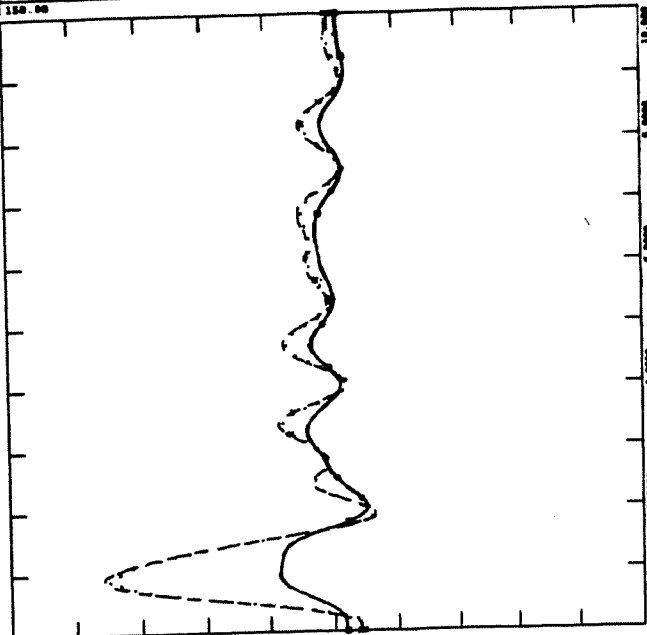

G218 STUDY
STUDY CASE WITH OPT.2 UPGRADES

FILE: G218 CCT9.OUT

150.00	CHEG 26: (ANAL 27800 (11)MTR 248.00) (2 1)	-50.00
150.00	CHEG 27: (ANAL 27800 (11)MTR 248.00) (2 1)	-50.00
150.00	CHEG 28: (ANAL 27800 (11)MTR 248.00) (2 1)	-50.00
150.00	CHEG 29: (ANAL 27800 (11)MTR 248.00) (2 1)	-50.00
150.00	CHEG 30: (ANAL 27800 (11)MTR 248.00) (2 1)	-50.00
150.00	CHEG 31: (ANAL 27800 (11)MTR 248.00) (2 1)	-50.00
150.00	CHEG 32: (ANAL 27800 (11)MTR 248.00) (2 1)	-50.00
150.00	CHEG 33: (ANAL 27800 (11)MTR 248.00) (2 1)	-50.00

TUE, FEB 25 2003 17:19
LJEE

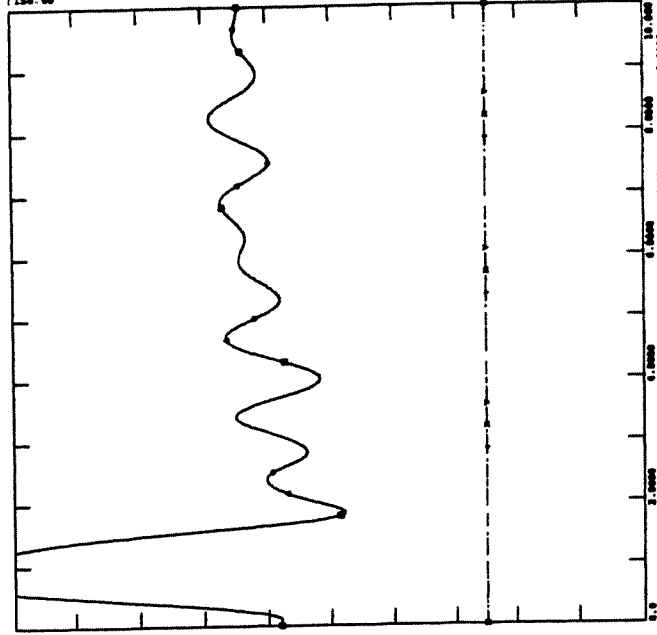

G218 STUDY
STUDY CASE WITH OPT.2 UPGRADES

FILE: G218 CCT9.OUT

1.1000	CHEG 2: (ANAL 18127 (02) BFW 20.780) (1 1)	0.0000
150.00	CHEG 3: (ANAL 18127 (02) BFW 20.780) (1 1)	-50.00

TUE, FEB 25 2003 17:19
SWING BUS

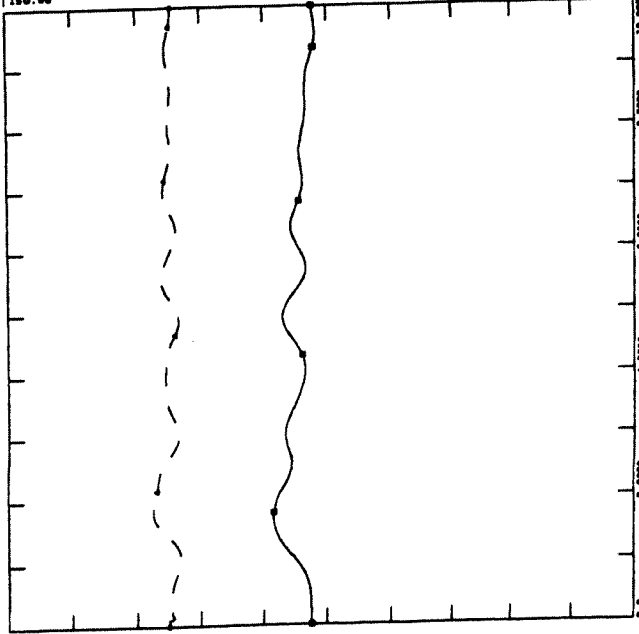

G218 STUDY
STUDY CASE WITH OPT.2 UPGRADES

FILE: G218 CCT9.OUT

150.00	CHEG 21: (ANAL 27800 (11)MTR 248.00) (4 1)	-50.00
150.00	CHEG 22: (ANAL 27800 (11)MTR 248.00) (4 1)	-50.00
150.00	CHEG 23: (ANAL 27800 (11)MTR 248.00) (2 1)	-50.00
150.00	CHEG 24: (ANAL 27800 (11)MTR 248.00) (10)	-50.00
150.00	CHEG 25: (ANAL 27800 (11)MTR 248.00) (2 1)	-50.00
150.00	CHEG 26: (ANAL 27800 (11)MTR 248.00) (4 1)	-50.00
150.00	CHEG 27: (ANAL 27800 (11)MTR 248.00) (4 1)	-50.00

TUE, FEB 25 2003 17:19
LJEE

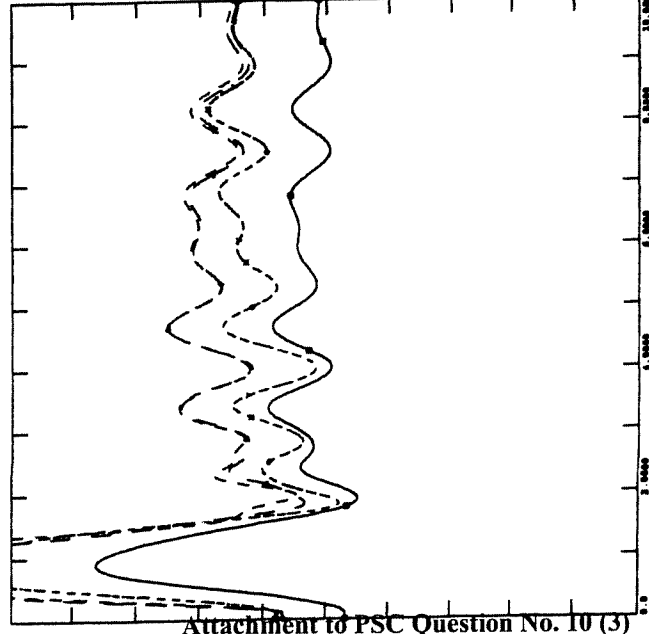



G218 STUDY
STUDY CASE WITH OPT.2 UPGRADES

FILE: G218 CCT9.OUT

150.00	CHNL 49: [ANGL 27592] [11CHN 8218.00] [1 1]	-50.00
150.00	CHNL 50: [ANGL 27577] [11CHN 8218.00] [6 1]	-50.00
150.00	CHNL 51: [ANGL 27577] [11CHN 8218.00] [2 1]	-50.00
150.00	CHNL 52: [ANGL 27577] [11CHN 8218.00] [6 1]	-50.00
150.00	CHNL 53: [ANGL 27577] [11CHN 8218.00] [11 1]	-50.00
150.00	CHNL 54: [ANGL 27592] [11CHN 8218.00] [2 1]	-50.00

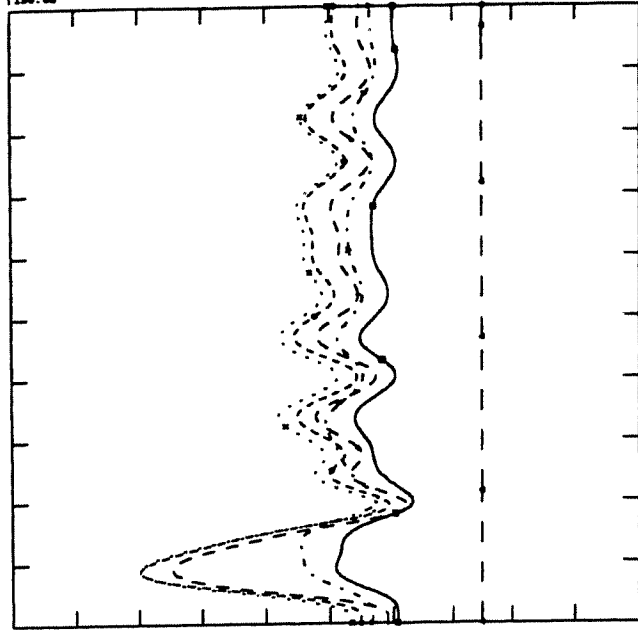

G218 STUDY
STUDY CASE WITH OPT.2 UPGRADES

FILE: G218 CCT9.OUT

150.00	CHNL 55: [ANGL 27592] [11CHN 82.000] [6 1]	-50.00
150.00	CHNL 56: [ANGL 27592] [11CHN 82.000] [4 1]	-50.00
150.00	CHNL 57: [ANGL 27592] [11CHN 82.000] [2 1]	-50.00
150.00	CHNL 58: [ANGL 27592] [11CHN 82.000] [2 1]	-50.00
150.00	CHNL 59: [ANGL 27592] [11CHN 82.000] [2 1]	-50.00
150.00	CHNL 60: [ANGL 27592] [11CHN 82.000] [2 1]	-50.00
150.00	CHNL 61: [ANGL 27592] [11CHN 82.000] [2 1]	-50.00
150.00	CHNL 62: [ANGL 27592] [11CHN 82.000] [2 1]	-50.00
150.00	CHNL 63: [ANGL 27592] [11CHN 82.000] [2 1]	-50.00
150.00	CHNL 64: [ANGL 27592] [11CHN 82.000] [2 1]	-50.00
150.00	CHNL 65: [ANGL 27592] [11CHN 82.000] [2 1]	-50.00
150.00	CHNL 66: [ANGL 27592] [11CHN 82.000] [2 1]	-50.00
150.00	CHNL 67: [ANGL 27592] [11CHN 82.000] [2 1]	-50.00

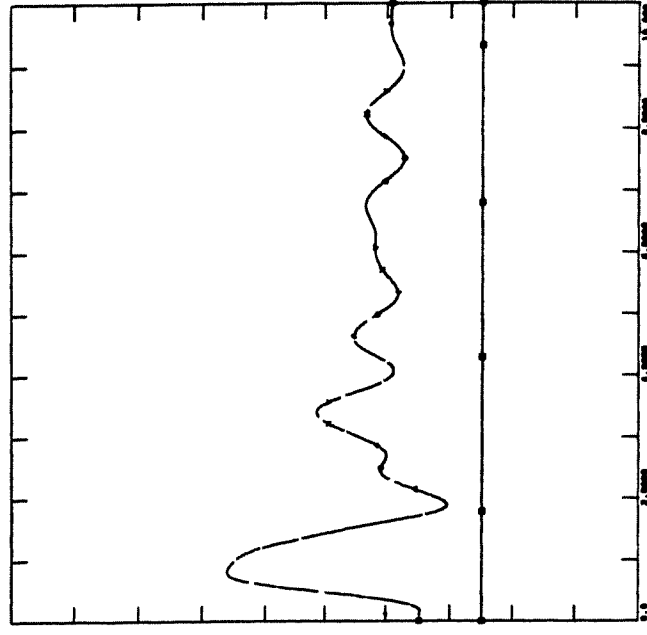

G218 STUDY
STUDY CASE WITH OPT.2 UPGRADES

FILE: G218 CCT9.OUT

150.00	CHNL 68: [ANGL 27592] [11CHN 8218.00] [1 1]	-50.00
150.00	CHNL 69: [ANGL 27592] [11CHN 8218.00] [2 1]	-50.00
150.00	CHNL 70: [ANGL 27592] [11CHN 8218.00] [6 1]	-50.00
150.00	CHNL 71: [ANGL 27592] [11CHN 8218.00] [6 1]	-50.00
150.00	CHNL 72: [ANGL 27592] [11CHN 8218.00] [7 1]	-50.00
150.00	CHNL 73: [ANGL 27592] [11CHN 8218.00] [6 1]	-50.00

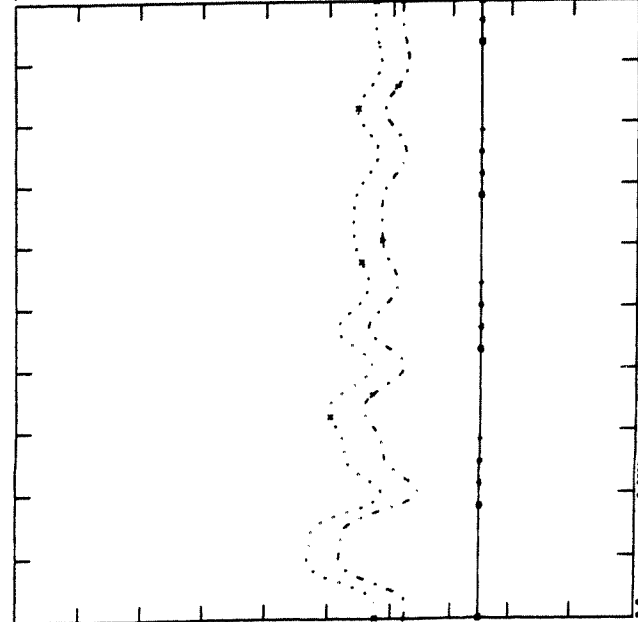

G218 STUDY
STUDY CASE WITH OPT.2 UPGRADES

FILE: G218 CCT9.OUT

150.00	CHNL 74: [ANGL 27592] [11CHN 8218.00] [7 1]	-50.00
150.00	CHNL 75: [ANGL 27592] [11CHN 8218.00] [2 1]	-50.00
150.00	CHNL 76: [ANGL 27592] [11CHN 8218.00] [2 1]	-50.00
150.00	CHNL 77: [ANGL 27592] [11CHN 8218.00] [12 1]	-50.00
150.00	CHNL 78: [ANGL 27592] [11CHN 8218.00] [12 1]	-50.00
150.00	CHNL 79: [ANGL 27592] [11CHN 8218.00] [4 1]	-50.00
150.00	CHNL 80: [ANGL 27592] [11CHN 8218.00] [2 1]	-50.00
150.00	CHNL 81: [ANGL 27592] [11CHN 8218.00] [2 1]	-50.00

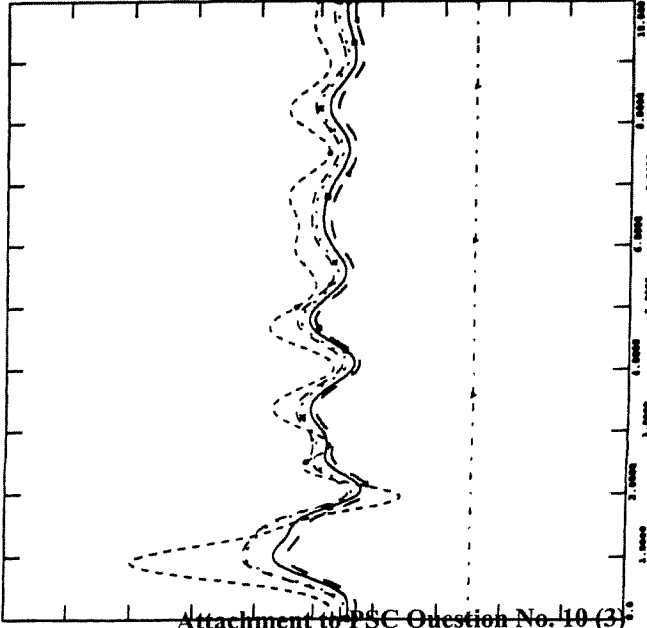

G218 STUDY
STUDY CASE WITH OPT.2 UPGRADES

FILE: G218_CCT9.OUT

150.00	CHNL 41: [ANGL 27216 [11]KCHN148.000] [1 1]	-50.00
150.00	CHNL 42: [ANGL 27220 [11]KCHN148.000] [2 1]	-50.00
150.00	CHNL 43: [ANGL 27224 [11]KCHN148.000] [3 1]	-50.00
150.00	CHNL 44: [ANGL 27228 [11]KCHN148.000] [4 1]	-50.00
150.00	CHNL 45: [ANGL 27232 [11]KCHN148.000] [5 1]	-50.00
150.00	CHNL 46: [ANGL 27236 [11]KCHN148.000] [6 1]	-50.00
150.00	CHNL 47: [ANGL 27240 [11]KCHN148.000] [7 1]	-50.00
150.00	CHNL 48: [ANGL 27244 [11]KCHN148.000] [8 1]	-50.00
150.00	CHNL 49: [ANGL 27248 [11]KCHN148.000] [9 1]	-50.00
150.00	CHNL 50: [ANGL 27252 [11]KCHN148.000] [10 1]	-50.00

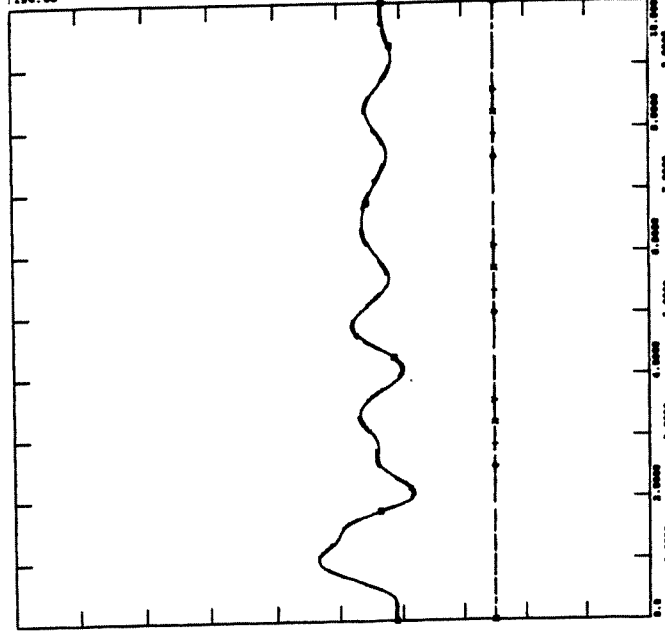

TUE, FEB 25 2003 17:19
LGBE

G218 STUDY
STUDY CASE WITH OPT.2 UPGRADES

FILE: G218_CCT9.OUT

150.00	CHNL 71: [ANGL 27228 [11]KCHN148.000] [1 1]	-50.00
150.00	CHNL 72: [ANGL 27232 [11]KCHN148.000] [2 1]	-50.00
150.00	CHNL 73: [ANGL 27236 [11]KCHN148.000] [3 1]	-50.00

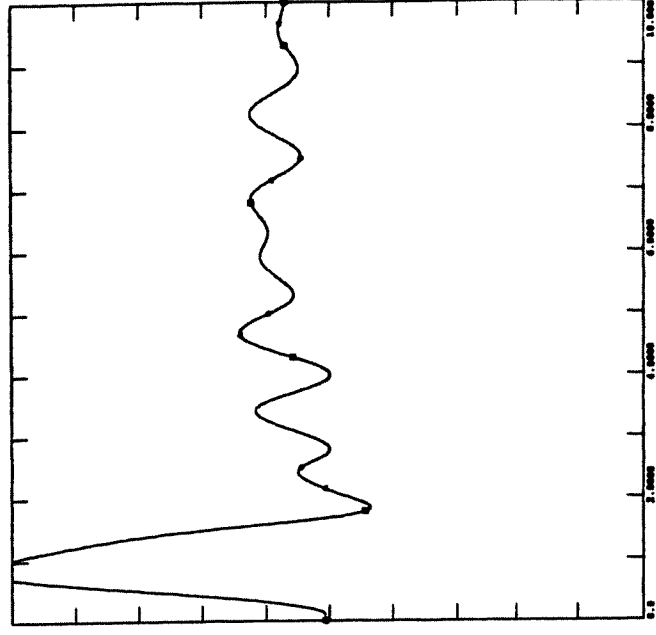

TUE, FEB 25 2003 17:19
LGBE

G218 STUDY
STUDY CASE WITH OPT.2 UPGRADES

FILE: G218_CCT9.OUT

150.00	CHNL 51: [ANGL 27196 [11]KCHN148.000] [1 1]	-50.00
150.00	CHNL 52: [ANGL 27200 [11]KCHN148.000] [2 1]	-50.00
150.00	CHNL 53: [ANGL 27204 [11]KCHN148.000] [3 1]	-50.00
150.00	CHNL 54: [ANGL 27208 [11]KCHN148.000] [4 1]	-50.00
150.00	CHNL 55: [ANGL 27212 [11]KCHN148.000] [5 1]	-50.00
150.00	CHNL 56: [ANGL 27216 [11]KCHN148.000] [6 1]	-50.00
150.00	CHNL 57: [ANGL 27220 [11]KCHN148.000] [7 1]	-50.00
150.00	CHNL 58: [ANGL 27224 [11]KCHN148.000] [8 1]	-50.00
150.00	CHNL 59: [ANGL 27228 [11]KCHN148.000] [9 1]	-50.00
150.00	CHNL 60: [ANGL 27232 [11]KCHN148.000] [10 1]	-50.00

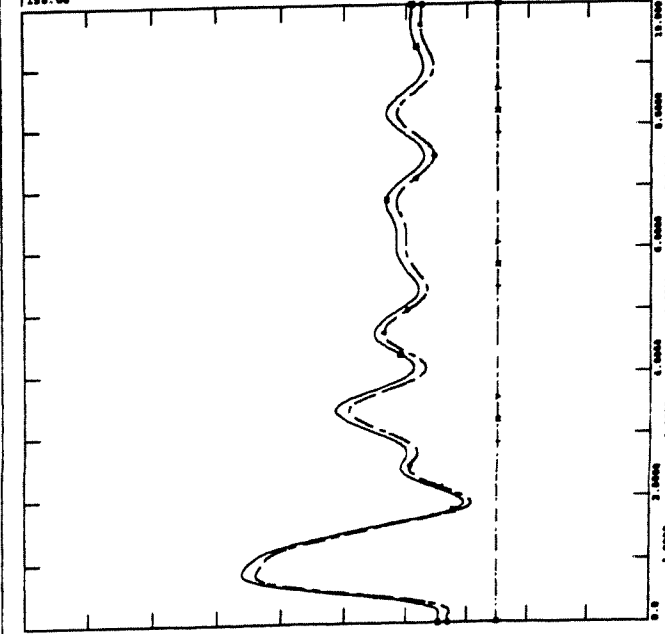

TUE, FEB 25 2003 17:19
LGBE

G218 STUDY
STUDY CASE WITH OPT.2 UPGRADES

FILE: G218_CCT9.OUT

150.00	CHNL 74: [ANGL 27216 [11]KCHN148.000] [1 1]	-50.00
150.00	CHNL 75: [ANGL 27220 [11]KCHN148.000] [2 1]	-50.00
150.00	CHNL 76: [ANGL 27224 [11]KCHN148.000] [3 1]	-50.00
150.00	CHNL 77: [ANGL 27228 [11]KCHN148.000] [4 1]	-50.00
150.00	CHNL 78: [ANGL 27232 [11]KCHN148.000] [5 1]	-50.00
150.00	CHNL 79: [ANGL 27236 [11]KCHN148.000] [6 1]	-50.00
150.00	CHNL 80: [ANGL 27240 [11]KCHN148.000] [7 1]	-50.00
150.00	CHNL 81: [ANGL 27244 [11]KCHN148.000] [8 1]	-50.00
150.00	CHNL 82: [ANGL 27248 [11]KCHN148.000] [9 1]	-50.00
150.00	CHNL 83: [ANGL 27252 [11]KCHN148.000] [10 1]	-50.00

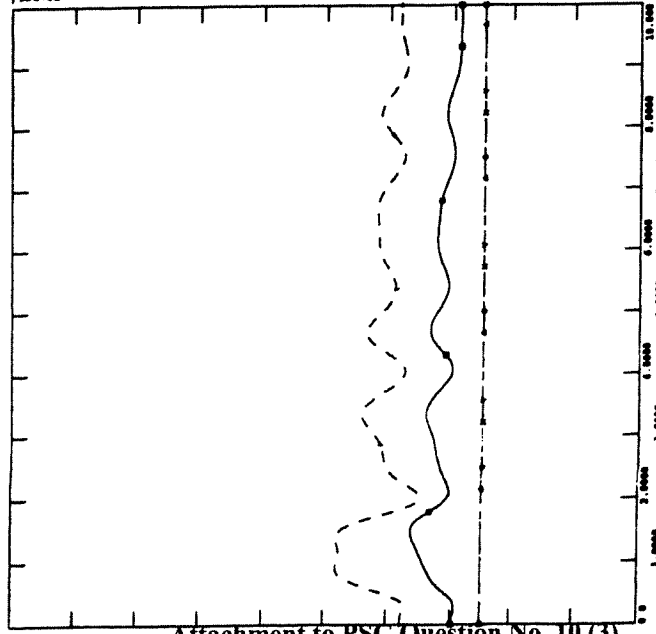

TUE, FEB 25 2003 17:19
LGBE

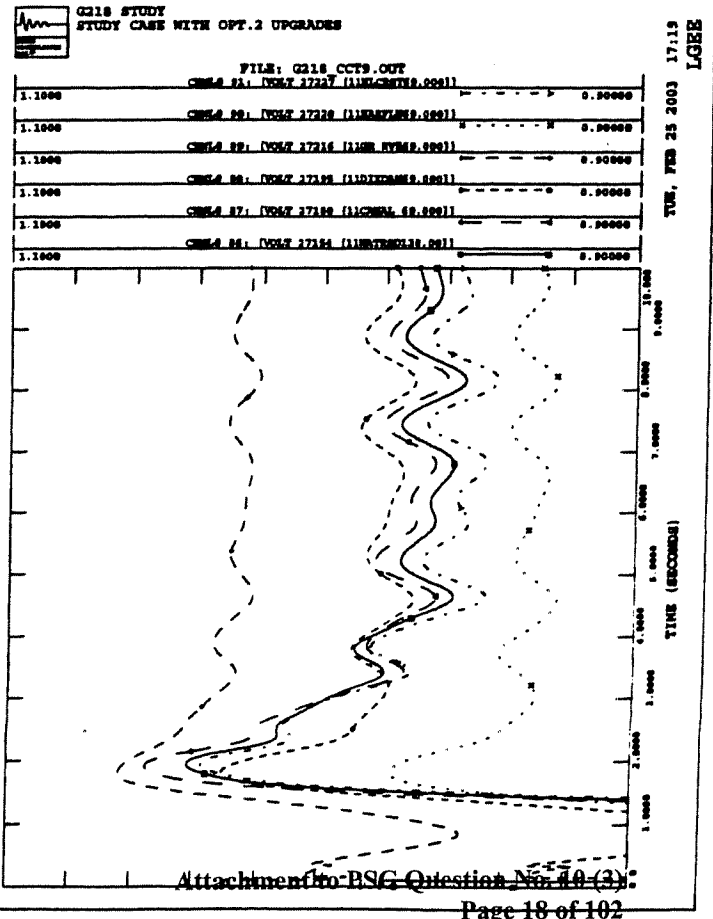
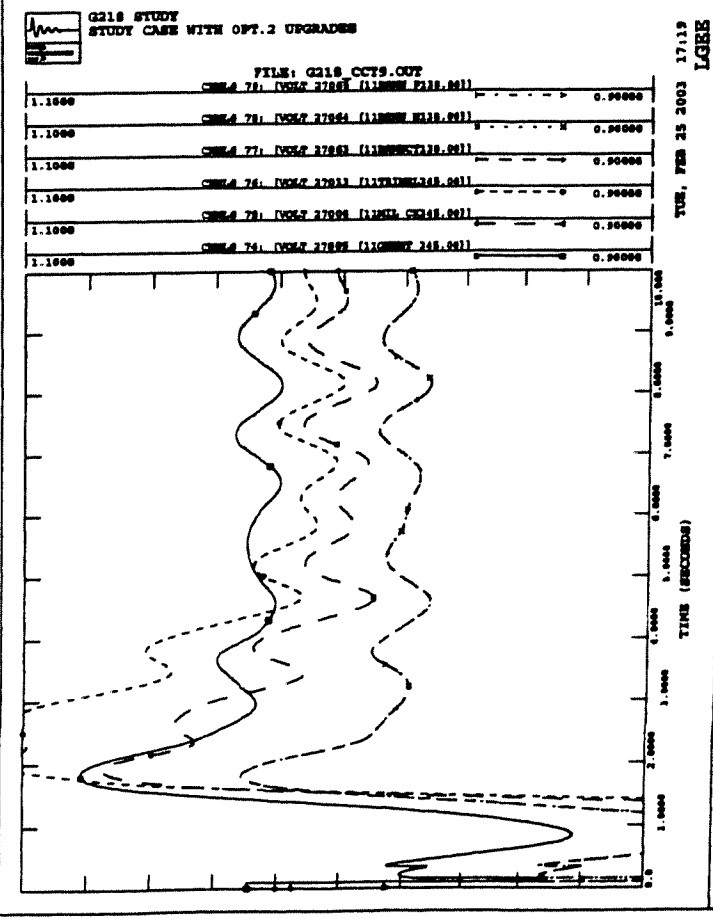
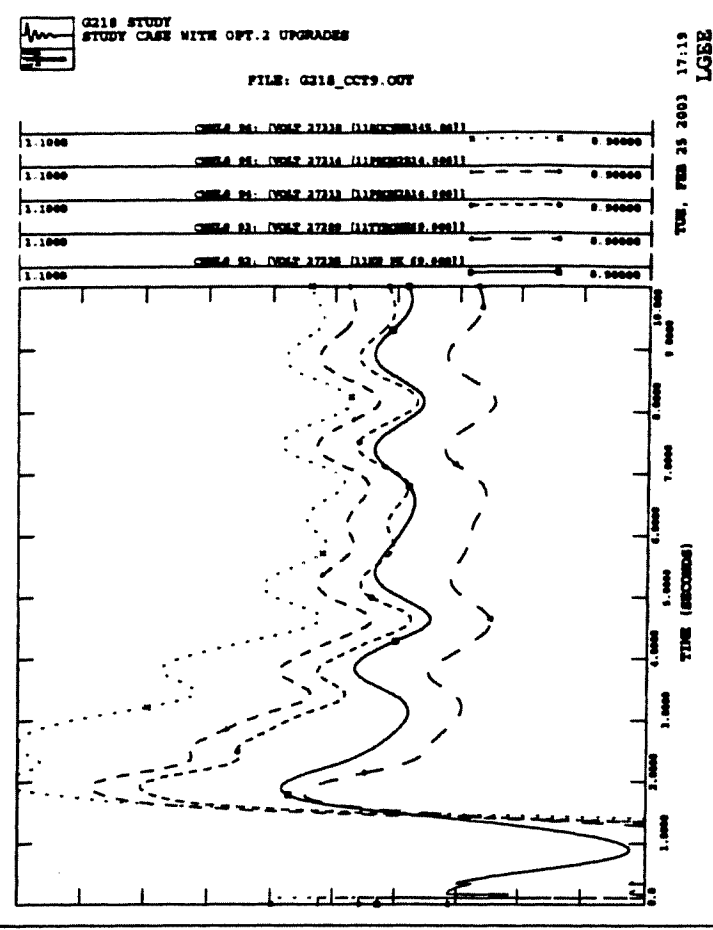
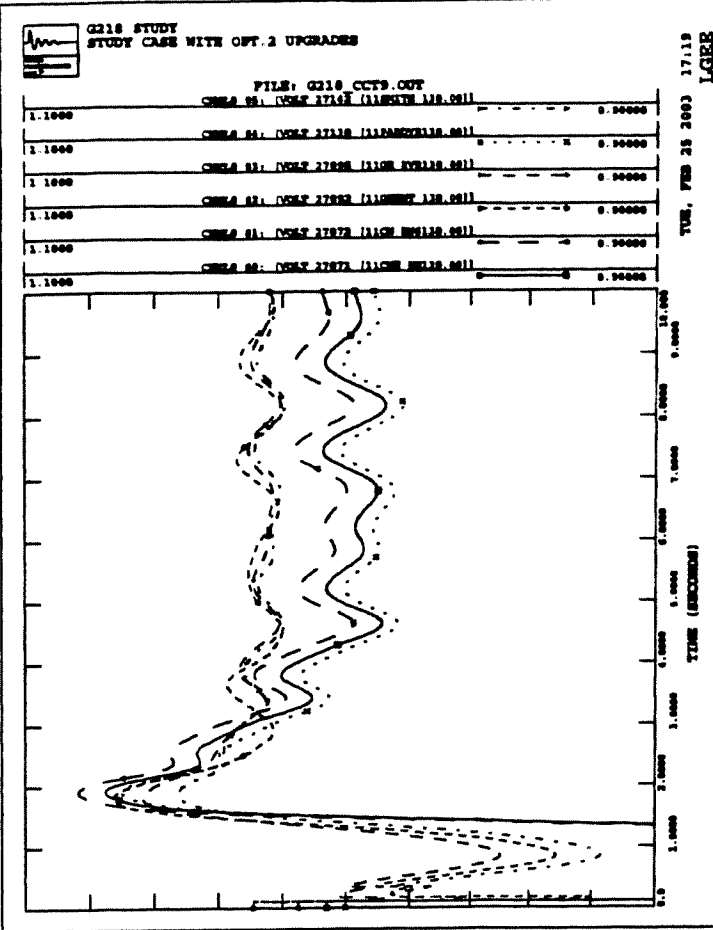

Attachment to BSC Question No. 40 (3)



G218 STUDY
STUDY CASE WITH OPT.2 UPGRADES

FILE: G218_CCT9.OUT

150.00	CHRG 112: [ANAL 27964 [16PWR 128.000] [1]]	-50.00
150.00	CHRG 113: [ANAL 28162 [16PWR 212.000] [2]]	-50.00
150.00	CHRG 118: [ANAL 28163 [16PWR 212.000] [2]]	-50.00
150.00	CHRG 189: [ANAL 28164 [16PWR 212.000] [2]]	-50.00
150.00	CHRG 190: [ANAL 28165 [16PWR 212.000] [2]]	-50.00
150.00	CHRG 191: [ANAL 28166 [16PWR 212.000] [2]]	-50.00
150.00	CHRG 192: [ANAL 28167 [16PWR 212.000] [2]]	-50.00

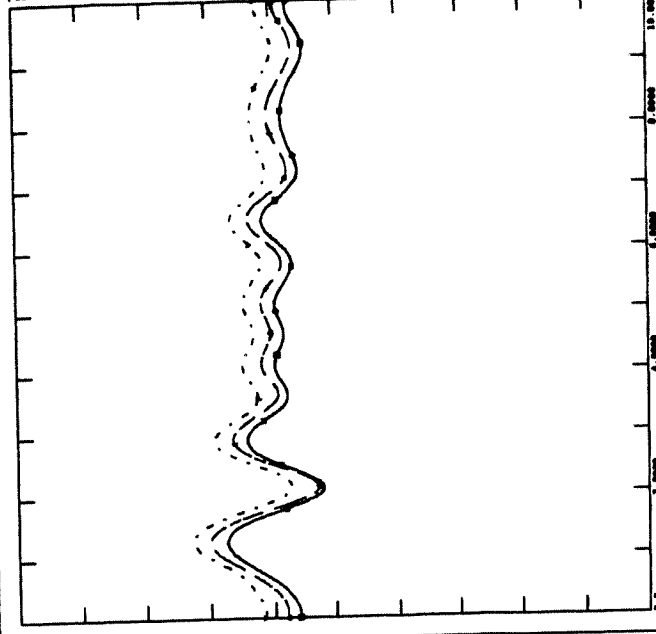

TUE, FEB 25 2003 17:19
CIN



G218 STUDY
STUDY CASE WITH OPT.2 UPGRADES

FILE: G218_CCT9.OUT

150.00	CHRG 121: [ANAL 28210 [16PWR 22.000] [1]]	-50.00
150.00	CHRG 129: [ANAL 28210 [16PWR 18.000] [2]]	-50.00
150.00	CHRG 132: [ANAL 28217 [16PWR 18.000] [2]]	-50.00

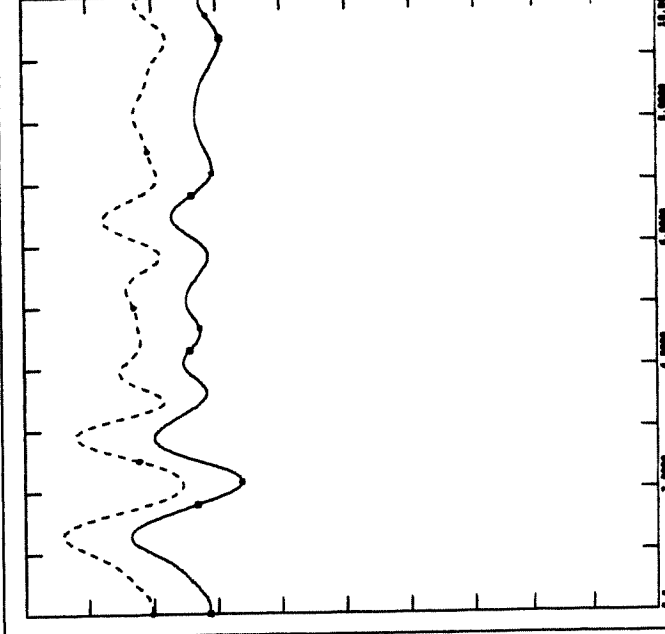

TUE, FEB 25 2003 17:19
CIN



G218 STUDY
STUDY CASE WITH OPT.2 UPGRADES

FILE: G218_CCT9.OUT

150.00	CHRG 185: [ANAL 28227 [16PWR 24.000] [1]]	-50.00
150.00	CHRG 186: [ANAL 28228 [16PWR 24.000] [1]]	-50.00
150.00	CHRG 187: [ANAL 28227 [16PWR 24.000] [4]]	-50.00
150.00	CHRG 188: [ANAL 28228 [16PWR 24.000] [2]]	-50.00
150.00	CHRG 189: [ANAL 28228 [16PWR 24.000] [2]]	-50.00
150.00	CHRG 193: [ANAL 28224 [16PWR 24.000] [1]]	-50.00

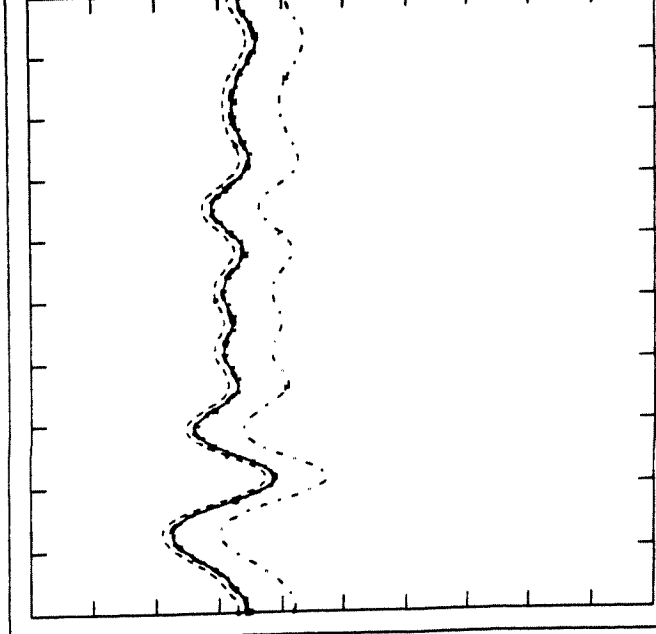

TUE, FEB 25 2003 17:19
CIN



G218 STUDY
STUDY CASE WITH OPT.2 UPGRADES

FILE: G218_CCT9.OUT

150.00	CHRG 118: [ANAL 28228 [16PWR 18.000] [1]]	-50.00
150.00	CHRG 117: [ANAL 28228 [16PWR 212.000] [1]]	-50.00
150.00	CHRG 116: [ANAL 28228 [16PWR 212.000] [1]]	-50.00
150.00	CHRG 114: [ANAL 27844 [16PWR 222.000] [4]]	-50.00
150.00	CHRG 114: [ANAL 27843 [16PWR 222.000] [2]]	-50.00
150.00	CHRG 113: [ANAL 27842 [16PWR 222.000] [2]]	-50.00

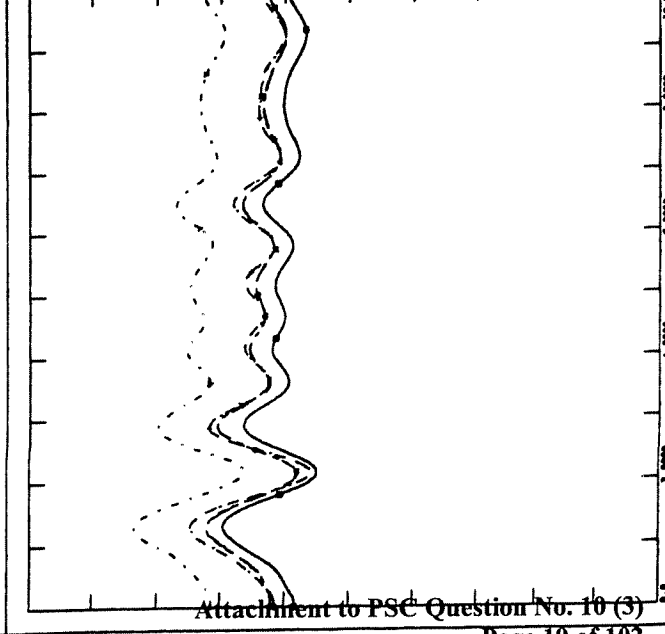

TUE, FEB 25 2003 17:19
CIN

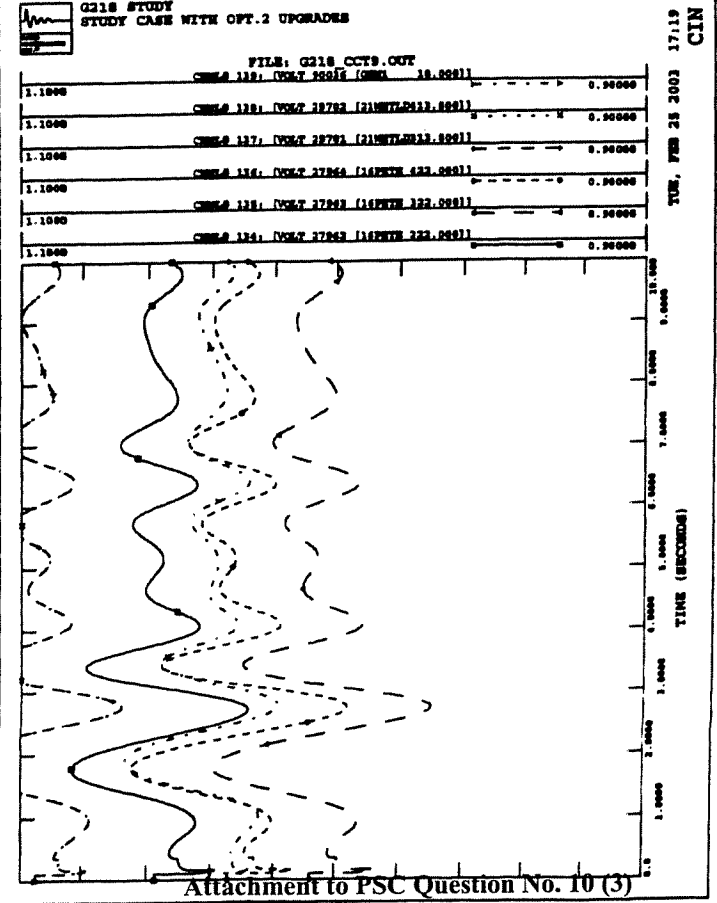
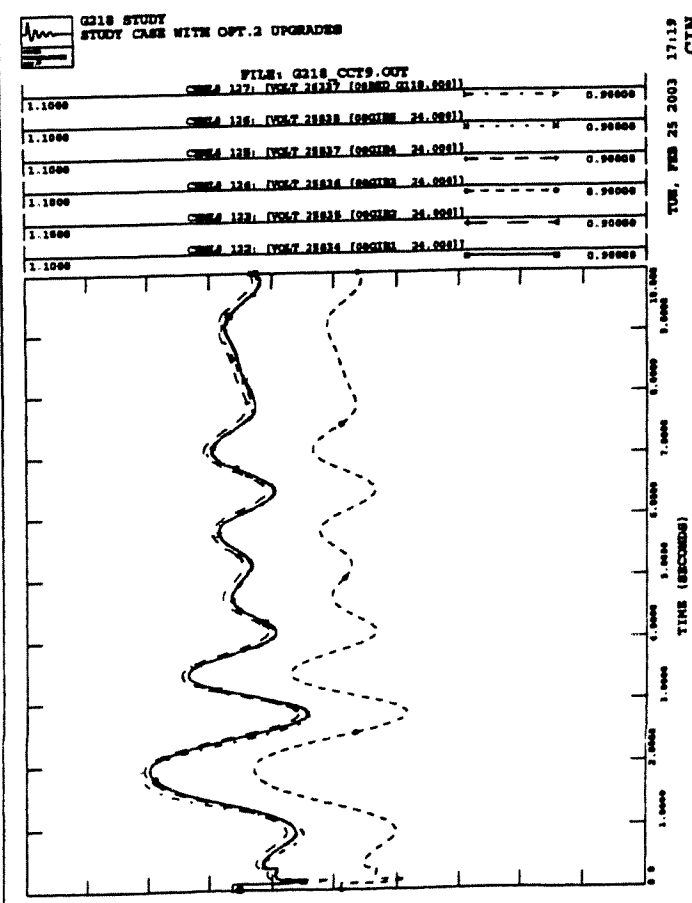
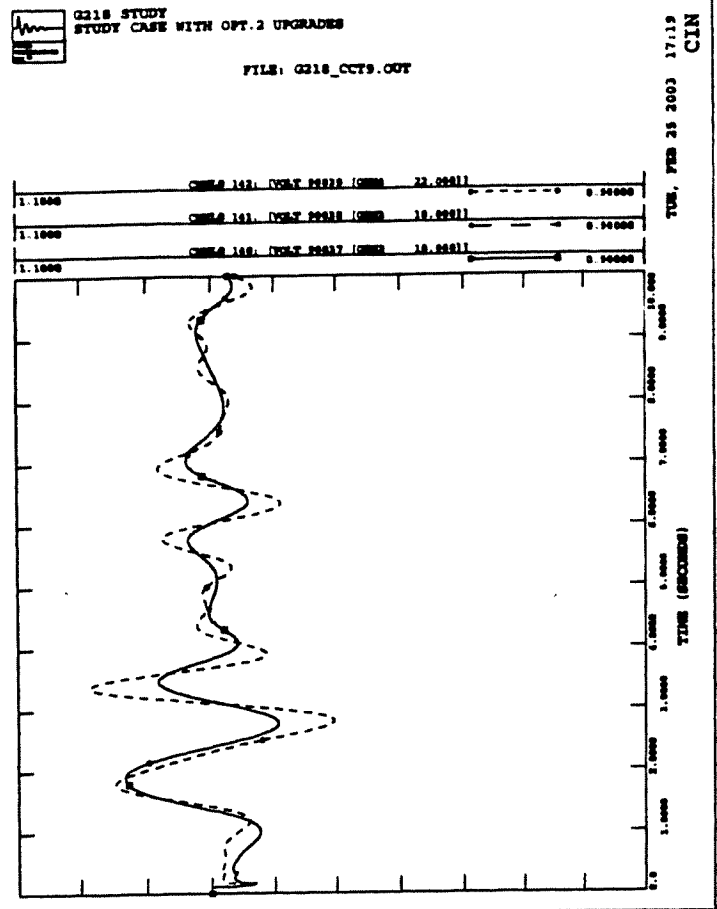
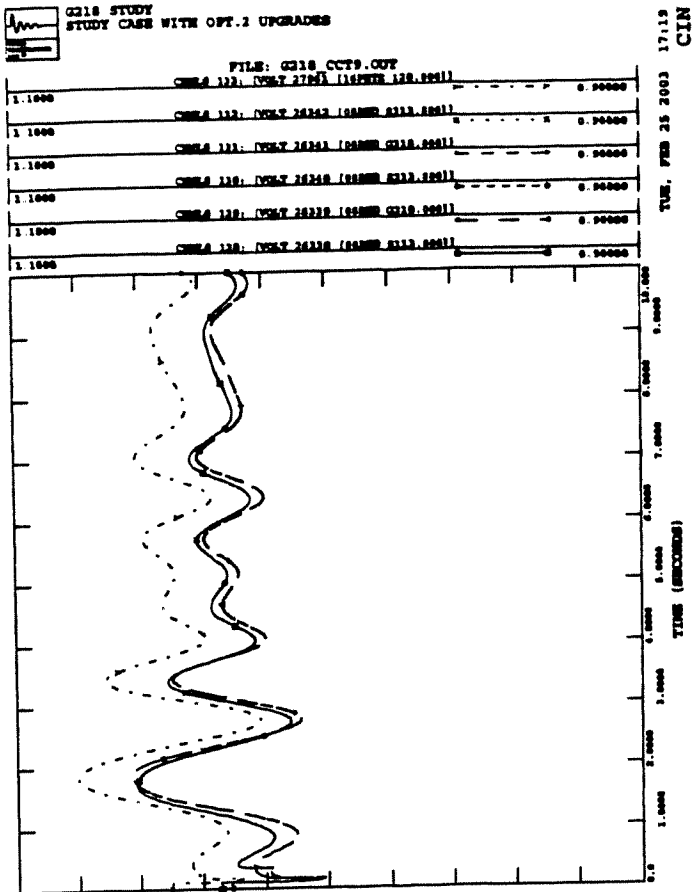

G218 STUDY
STUDY CASE WITH OPT.2 UPGRADES

FILE: G218_CCT9.OUT

CHNL	INSTR	DATE	TIME	VAL
CHNL 212	[ANAL 22217]	[2025FEB18.00]	[4.1]	-50.00
CHNL 213	[ANAL 22218]	[2025FEB18.00]	[4.1]	-50.00
CHNL 218	[ANAL 22219]	[2025FEB18.00]	[4.1]	-50.00
CHNL 209	[ANAL 22220]	[2025FEB 18.00]	[2.1]	-50.00
CHNL 208	[ANAL 22221]	[2025FEB 18.00]	[2.1]	-50.00
CHNL 207	[ANAL 22222]	[2025FEB 18.00]	[2.1]	-50.00

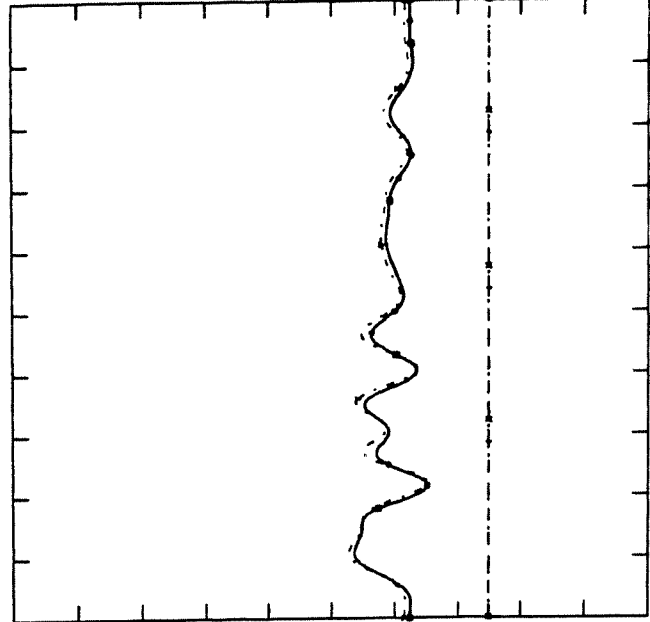

TUE, FEB 25 2003 17:19
EKPC

G218 STUDY
STUDY CASE WITH OPT.2 UPGRADES

FILE: G218_CCT9.OUT

CHNL	INSTR	DATE	TIME	VAL
CHNL 221	[ANAL 22223]	[2025FEB18.00]	[2.1]	-50.00
CHNL 220	[ANAL 22224]	[2025FEB 21.00]	[2.1]	-50.00
CHNL 219	[ANAL 22225]	[2025FEB 21.00]	[2.1]	-50.00

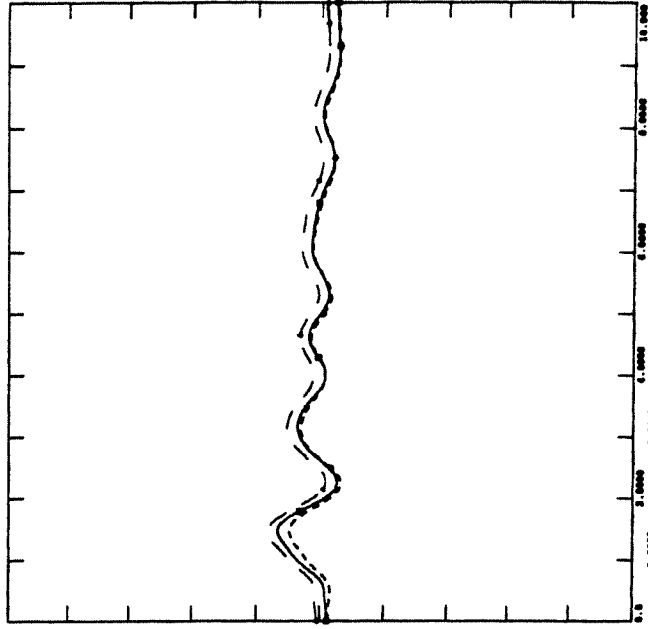

TUE, FEB 25 2003 17:19
EKPC

G218 STUDY
STUDY CASE WITH OPT.2 UPGRADES

FILE: G218_CCT9.OUT

CHNL	INSTR	DATE	TIME	VAL
CHNL 204	[ANAL 22226]	[2025FEB 18.00]	[4.1]	-50.00
CHNL 203	[ANAL 22227]	[2025FEB 18.00]	[2.1]	-50.00
CHNL 204	[ANAL 22228]	[2025FEB 18.00]	[2.1]	-50.00
CHNL 203	[ANAL 22229]	[2025FEB 18.00]	[1.1]	-50.00
CHNL 202	[ANAL 22230]	[2025FEB 20.00]	[2.1]	-50.00
CHNL 201	[ANAL 22231]	[2025FEB 18.00]	[1.1]	-50.00

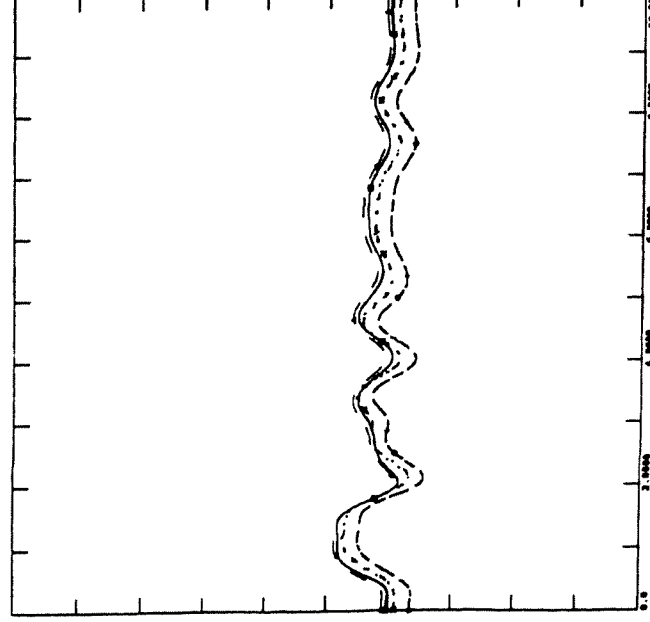

TUE, FEB 25 2003 17:19
EKPC

G218 STUDY
STUDY CASE WITH OPT.2 UPGRADES

FILE: G218_CCT9.OUT

CHNL	INSTR	DATE	TIME	VAL
CHNL 218	[ANAL 22414]	[2025FEB 18.00]	[1.1]	-50.00
CHNL 217	[ANAL 22234]	[2025FEB18.00]	[2.1]	-50.00
CHNL 216	[ANAL 22235]	[2025FEB18.00]	[7.1]	-50.00
CHNL 215	[ANAL 22237]	[2025FEB18.00]	[6.1]	-50.00
CHNL 214	[ANAL 22237]	[2025FEB18.00]	[6.1]	-50.00
CHNL 213	[ANAL 22237]	[2025FEB18.00]	[5.1]	-50.00

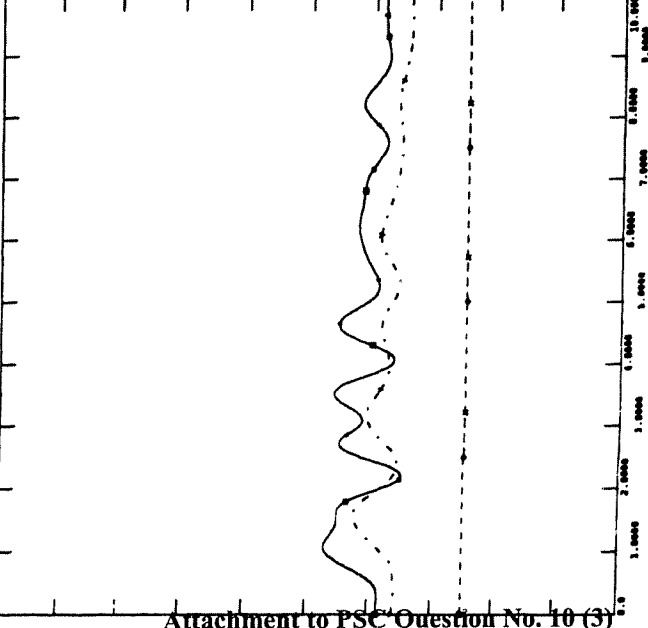

TUE, FEB 25 2003 17:19
EKPC

G218 STUDY
STUDY CASE WITH OPT.2 UPGRADES

FILE: G218_CCT9.OUT

1.1000	CHSA 227: [VOLT 2222] [2012/02/12 12:00]	0.90000
1.1000	CHSA 228: [VOLT 2222] [2012/02/12 12:00]	0.90000
1.1000	CHSA 229: [VOLT 2222] [2012/02/12 12:00]	0.90000
1.1000	CHSA 230: [VOLT 2222] [2012/02/12 12:00]	0.90000
1.1000	CHSA 231: [VOLT 2222] [2012/02/12 12:00]	0.90000
1.1000	CHSA 232: [VOLT 2222] [2012/02/12 12:00]	0.90000

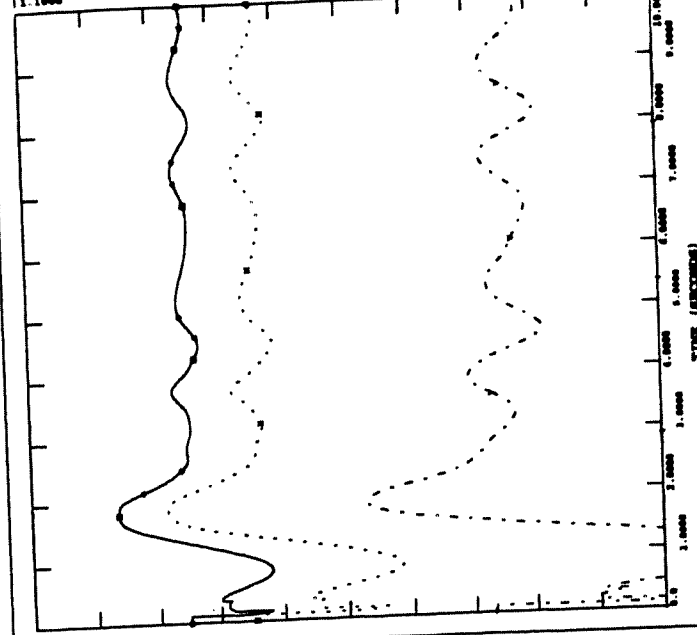

TUE, FEB 25 2003 17:19
EKPC

G218 STUDY
STUDY CASE WITH OPT.2 UPGRADES

FILE: G218_CCT9.OUT

150.00	CHSA 224: [VOLT 2422] [2012/02/12 12:00]	-50.00
150.00	CHSA 225: [VOLT 2422] [2012/02/12 12:00]	-50.00
150.00	CHSA 226: [VOLT 2422] [2012/02/12 12:00]	-50.00
150.00	CHSA 227: [VOLT 2422] [2012/02/12 12:00]	-50.00
150.00	CHSA 228: [VOLT 2422] [2012/02/12 12:00]	-50.00
150.00	CHSA 229: [VOLT 2422] [2012/02/12 12:00]	-50.00

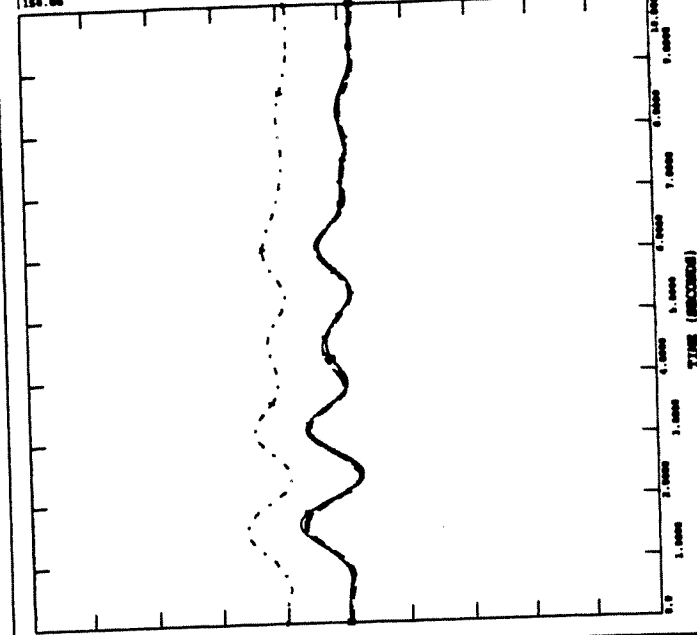

TUE, FEB 25 2003 17:19
OVEC

G218 STUDY
STUDY CASE WITH OPT.2 UPGRADES

FILE: G218_CCT9.OUT

1.1000	CHSA 227: [VOLT 2222] [2012/02/12 12:00]	0.90000
1.1000	CHSA 228: [VOLT 2222] [2012/02/12 12:00]	0.90000
1.1000	CHSA 229: [VOLT 2222] [2012/02/12 12:00]	0.90000
1.1000	CHSA 230: [VOLT 2222] [2012/02/12 12:00]	0.90000
1.1000	CHSA 231: [VOLT 2222] [2012/02/12 12:00]	0.90000
1.1000	CHSA 232: [VOLT 2222] [2012/02/12 12:00]	0.90000

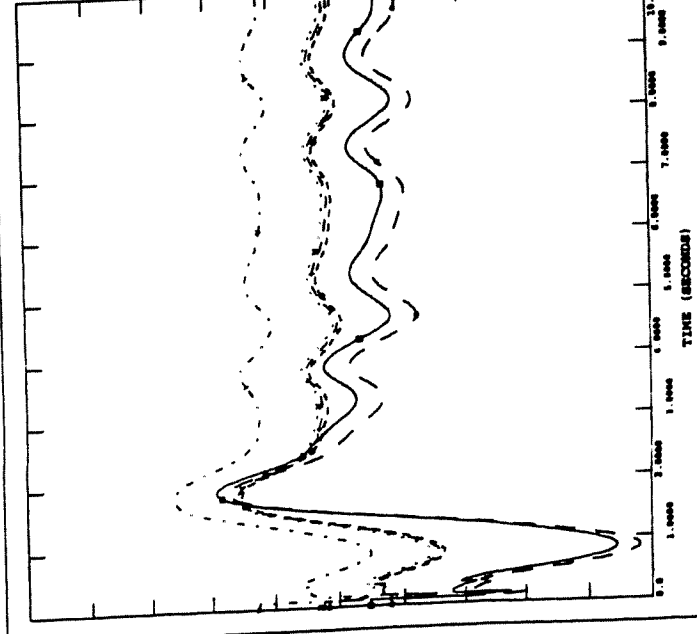

TUE, FEB 25 2003 17:19
EKPC

G218 STUDY
STUDY CASE WITH OPT.2 UPGRADES

FILE: G218_CCT9.OUT

1.1000	CHSA 227: [VOLT 2222] [2012/02/12 12:00]	0.90000
1.1000	CHSA 228: [VOLT 2222] [2012/02/12 12:00]	0.90000
1.1000	CHSA 229: [VOLT 2222] [2012/02/12 12:00]	0.90000
1.1000	CHSA 230: [VOLT 2222] [2012/02/12 12:00]	0.90000
1.1000	CHSA 231: [VOLT 2222] [2012/02/12 12:00]	0.90000
1.1000	CHSA 232: [VOLT 2222] [2012/02/12 12:00]	0.90000

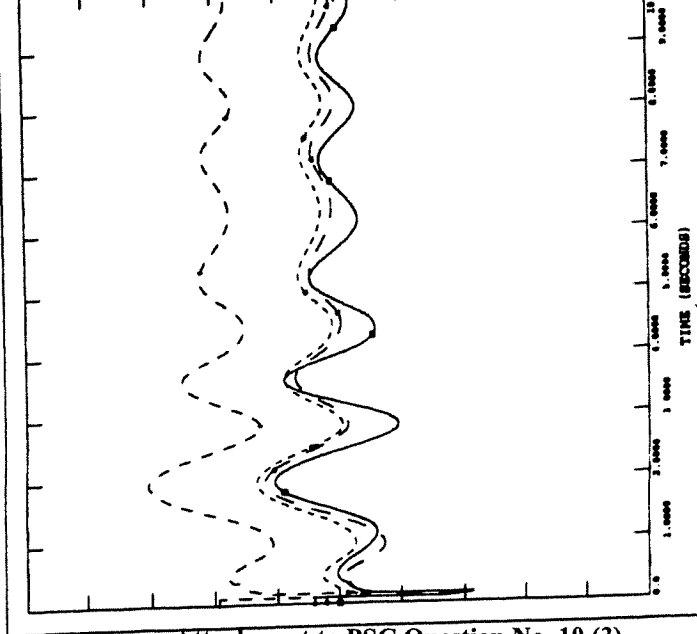

TUE, FEB 25 2003 17:19
EKPC

APPENDIX B

Table 1
Short Circuit Current
Option 1 - 3 Phase Fault
Change in Fault Current less than 5% has been excluded

		Base	Option 1	Delta	Delta
		Amperes	Amperes	Amperes	Amperes %
7683 [W FRNKFT 345]	AMPS	7,489.1	20,069.8	12,580.7	168.0
7685 [BROWN N_ 345]	AMPS	13,193.5	20,179.9	6,986.4	53.0
7669 [W FRNKFT 138]	AMPS	12,795.6	18,455.3	5,659.7	44.2
7795 [TRIMBLCO 345]	AMPS	38,380.1	48,126.3	9,746.2	25.4
7628 [TYRONE 138]	AMPS	14,074.5	17,346.4	3,271.9	23.2
7682 [W LEXNGT 345]	AMPS	12,699.3	14,844.0	2,144.7	16.9
7659 [BROWN N 138]	AMPS	43,164.0	50,130.3	6,966.3	16.1
7639 [HIGBY ML 138]	AMPS	22,417.8	25,774.0	3,356.2	15.0
7707 [BROWN T2 138]	AMPS	42,233.6	48,525.1	6,291.5	14.9
7706 [BROWN T1 138]	AMPS	42,223.0	48,512.8	6,289.8	14.9
7708 [BROWN P 138]	AMPS	41,861.2	47,866.3	6,005.1	14.3
7699 [BROWN CT 138]	AMPS	41,724.8	47,672.8	5,948.0	14.3
7673 [GHENT_2 345]	AMPS	25,265.0	28,544.6	3,279.6	13.0
7676 [W LEXNGT 138]	AMPS	24,523.7	27,570.9	3,047.2	12.4
7635 [W CLIFF 138]	AMPS	36,243.0	40,634.0	4,391.0	12.1
7634 [WC-DD 138]	AMPS	35,954.2	40,269.8	4,315.6	12.0

**Generation Interconnection Evaluation
Of a 750 MW Generating Power Plant
At Trimble County, KY**

7658 [CLAYS ML 138]	AMPS	18,105.2	20,055.7	1,950.5	10.8
6437 [GAL. STE 345]	AMPS	21,092.3	23,329.4	2,237.1	10.6
7684 [GALLT IN 345]	AMPS	20,847.7	23,031.1	2,183.4	10.5
7640 [FRANKF E 138]	AMPS	12,858.7	14,170.6	1,311.9	10.2
7631 [REYNOLDS 138]	AMPS	20,328.2	22,112.3	1,784.1	8.8
7728 [ALCALDE 345]	AMPS	7,688.4	8,341.2	652.8	8.5
7638 [LANSDWN 138]	AMPS	14,577.6	15,722.7	1,145.1	7.9
10003 [11BUCKNR 345]	AMPS	28,281.8	30,494.4	2,212.6	7.8
7636 [PISGAH_2 138]	AMPS	18,732.7	19,983.8	1,251.1	6.7
7780 [MIDDLTWN 345]	AMPS	29,557.0	31,210.2	1,653.2	5.6
7668 [SHADRACK 138]	AMPS	9,062.5	9,560.8	498.3	5.5
7608 [HARDN CO 345]	AMPS	8,318.4	8,760.4	442.0	5.3
7671 [MIDWAY 138]	AMPS	12,766.4	13,416.6	650.2	5.1
923 [CLIFTY 345]	AMPS	47,195.1	49,290.9	2,095.8	4.4
7630 [AMERI AV 138]	AMPS	20,608.7	21,422.7	814.0	3.9

Table 2
Short Circuit Current
Option 1 - SLG Faults
Change in Fault Current less than 5% has been excluded

		Base	Option 1 Delta	Delta
		Amperes	Amperes	Amperes %
7683 [W FRNKFT 345]	AMPS	6,311.3	14,391.7	8,080.4
7685 [BROWN N_ 345]	AMPS	11,609.1	17,872.9	6,263.8
7669 [W FRNKFT 138]	AMPS	15,628.6	22,150.9	6,522.3
7795 [TRIMBLCO 345]	AMPS	39,545.6	49,800.5	10,254.9
7628 [TYRONE 138]	AMPS	11,847.8	14,636.2	2,788.4
7639 [HIGBY ML 138]	AMPS	20,333.7	24,359.5	4,025.8
7676 [W LEXNGT 138]	AMPS	22,091.6	26,027.5	3,935.9
7682 [W LEXNGT 345]	AMPS	10,201.5	11,803.3	1,601.8
7659 [BROWN N 138]	AMPS	49,838.0	56,551.7	6,713.7
7706 [BROWN T1 138]	AMPS	48,113.8	53,884.3	5,770.5
7707 [BROWN T2 138]	AMPS	48,119.0	53,889.8	5,770.8
7658 [CLAYS ML 138]	AMPS	14,538.0	16,240.8	1,702.8
7708 [BROWN P 138]	AMPS	47,537.4	52,957.0	5,419.6
7699 [BROWN CT 138]	AMPS	47,549.5	52,942.1	5,392.6
7673 [GHENT_2 345]	AMPS	30,076.5	33,180.5	3,102.0
7631 [REYNOLDS 138]	AMPS	17,098.1	18,722.1	1,624.0
7635 [W CLIFF 138]	AMPS	37,188.5	40,388.1	3,199.6
7634 [WC-DD 138]	AMPS	36,634.4	39,735.4	3,101.0
				128.0
				54.0
				41.7
				25.9
				23.5
				19.8
				17.8
				15.7
				13.5
				12.0
				12.0
				11.7
				11.4
				11.3
				10.3
				9.5
				8.6
				8.5

**Generation Interconnection Evaluation
Of a 750 MW Generating Power Plant
At Trimble County, KY**

7638 [LANSWDN 138]	AMPS	12,358.8	13,297.6	938.8	7.6
6437 [GAL. STE 345]	AMPS	21,813.6	23,395.3	1,581.7	7.3
7640 [FRANKF E 138]	AMPS	12,215.7	13,080.0	864.3	7.1
7636 [PISGAH_2 138]	AMPS	15,153.8	16,220.1	1,066.3	7.0
7684 [GALLT IN 345]	AMPS	21,094.8	22,571.4	1,476.6	7.0
7728 [ALCALDE 345]	AMPS	6,855.8	7,260.6	404.8	5.9
7671 [MIDWAY 138]	AMPS	8,910.6	9,385.3	474.7	5.3
10003 [1 BUCKNR 345]	AMPS	26,480.5	27,866.7	1,386.2	5.2

Table 3
Short Circuit Current
Option 2 - 3 Phase Fault
Change in Fault Current less than 5% has been excluded

		Base	Option 1	Delta	Delta
		Amperes	Amperes	Amperes	Amperes %
7608 [HARDN CO 345]	AMPS	8,318.4	14,676.9	6,358.5	76.4
7683 [W FRNKFT 345]	AMPS	7,489.1	12,825.2	5,336.1	71.3
7685 [BROWN N_ 345]	AMPS	13,193.5	18,994.8	5,801.3	44.0
7704 [HARDN CO 138]	AMPS	14,378.2	17,307.6	2,929.4	20.4
7712 [ETOWN_2 138]	AMPS	12,996.4	15,197.6	2,201.2	16.9
7791 [MILL CRK 345]	AMPS	27,913.1	32,082.6	4,169.5	14.9
7659 [BROWN N 138]	AMPS	43,164.0	49,211.7	6,047.7	14.0
7669 [W FRNKFT 138]	AMPS	12,795.6	14,578.3	1,782.7	13.9
7795 [TRIMBLCO 345]	AMPS	38,380.1	43,674.0	5,293.9	13.8
7639 [HIGBY ML 138]	AMPS	22,417.8	25,397.2	2,979.4	13.3
7706 [BROWN T1 138]	AMPS	42,223.0	47,693.2	5,470.2	13.0
7707 [BROWN T2 138]	AMPS	42,233.6	47,704.4	5,470.8	13.0
7708 [BROWN P 138]	AMPS	41,861.2	47,081.3	5,220.1	12.5
7699 [BROWN CT 138]	AMPS	41,724.8	46,909.3	5,184.5	12.4
7682 [W LEXNGT 345]	AMPS	12,699.3	14,257.1	1,557.8	12.3
7635 [W CLIFF 138]	AMPS	36,243.0	40,065.1	3,822.1	10.5

**Generation Interconnection Evaluation
Of a 750 MW Generating Power Plant
At Trimble County, KY**

7634 [WC-DD 138]	AMPS	35,954.2	39,710.7	3,756.5	10.4
7676 [W LEXNGT 138]	AMPS	24,523.7	27,024.0	2,500.3	10.2
7658 [CLAYS ML 138]	AMPS	18,105.2	19,831.8	1,726.6	9.5
7715 [ROGERSVL 138]	AMPS	6,844.4	7,408.2	563.8	8.2
7603 [SMITH_2 345]	AMPS	12,999.6	14,045.1	1,045.5	8.0
7793 [BLUELICK 345]	AMPS	21,805.4	23,444.8	1,639.4	7.5
7631 [REYNOLDS 138]	AMPS	20,328.2	21,824.0	1,495.8	7.4
7728 [ALCALDE 345]	AMPS	7,688.4	8,253.1	564.7	7.3
7780 [MIDDLTWN 345]	AMPS	29,557.0	31,714.7	2,157.7	7.3
7638 [LANSDOWN 138]	AMPS	14,577.6	15,582.6	1,005.0	6.9
10003 [11BUCKNR 345]	AMPS	28,281.8	29,932.0	1,650.2	5.8
7673 [GHENT_2 345]	AMPS	25,265.0	26,728.2	1,463.2	5.8
7794 [PADDYWST 345]	AMPS	17,467.8	18,464.7	996.9	5.7
7636 [PISGAH_2 138]	AMPS	18,732.7	19,702.9	970.2	5.2

Table 4
Short Circuit Current
Option 2 - SLG Faults
Change in Fault Current less than 5% has been excluded

	Base Amperes	Option 1 Amperes	Delta Amperes %		
7683[W FRNKFT 345]	AMPS	6,311.3	10,041.0	3,729.7	59.1
7608[HARDN CO 345]	AMPS	6,954.1	10,885.4	3,931.3	56.5
7685[BROWN N_ 345]	AMPS	11,609.1	17,342.7	5,733.6	49.4
7704[HARDN CO 138]	AMPS	14,543.9	17,154.9	2,611.0	18.0
7795[TRIMBLCO 345]	AMPS	39,545.6	46,097.2	6,551.6	16.6
7669[W FRNKFT 138]	AMPS	15,628.6	17,868.8	2,240.2	14.3
7791[MILL CRK 345]	AMPS	32,023.7	35,843.8	3,820.1	11.9
7659[BROWN N 138]	AMPS	49,838.0	55,779.3	5,941.3	11.9
7682[W LEXNGT 345]	AMPS	10,201.5	11,378.1	1,176.6	11.5
7639[HIGBY ML 138]	AMPS	20,333.7	22,676.3	2,342.6	11.5
7712[ETOWN_2 138]	AMPS	12,647.5	14,076.1	1,428.6	11.3
7706[BROWN T1 138]	AMPS	48,113.8	53,213.6	5,099.8	10.6
7707[BROWN T2 138]	AMPS	48,119.0	53,218.3	5,099.3	10.6
7676[W LEXNGT 138]	AMPS	22,091.6	24,359.8	2,268.2	10.3
7708[BROWN P 138]	AMPS	47,537.4	52,318.1	4,780.7	10.1
7699[BROWN CT 138]	AMPS	47,549.5	52,316.5	4,767.0	10.0
7635[W CLIFF 138]	AMPS	37,188.5	40,014.1	2,825.6	7.6
7634[WC-DD 138]	AMPS	36,634.4	39,373.3	2,738.9	7.5

Generation Interconnection Evaluation
 Of a 750 MW Generating Power Plant
 At Trimble County, KY

7658 [CLAYS ML 138]	AMPS	14,538.0	15,572.3	1,034.3	7.1
7631 [REYNOLDS 138]	AMPS	17,098.1	18,074.4	976.3	5.7
7715 [ROGERSVL 138]	AMPS	6,051.1	6,381.9	330.8	5.5
7728 [ALCALDE 345]	AMPS	6,855.8	7,217.9	362.1	5.3

Table 5
Short Circuit Current
Option 3 - 3 Phase Fault
Change in Fault Current less than 5% has been excluded

		Base	Option 1	Delta	Delta
		Amperes	Amperes	Amperes	%
7683[W FRNKFT 345]	AMPS	7,489.1	12,915.8	5,426.7	72.5
4768[SPEED 345]	AMPS	10,317.2	15,051.3	4,734.1	45.9
7685[BROWN N_ 345]	AMPS	13,193.5	18,336.9	5,143.4	39.0
7795[TRIMBLCO 345]	AMPS	38,380.1	50,966.2	12,586.1	32.8
4734[RAMSEY 345]	AMPS	8,297.8	9,726.0	1,428.2	17.2
4954[RAMSEY 345]	AMPS	8,297.8	9,726.0	1,428.2	17.2
7673[GHEENT_2 345]	AMPS	25,265.0	29,536.7	4,271.7	16.9
6437[GAL. STE 345]	AMPS	21,092.3	23,988.3	2,896.0	13.7
7684[GALL T IN 345]	AMPS	20,847.7	23,672.8	2,825.1	13.6
7669[W FRNKFT 138]	AMPS	12,795.6	14,481.8	1,686.2	13.2
7639[HIGBY ML 138]	AMPS	22,417.8	25,308.7	2,890.9	12.9
7659[BROWN N 138]	AMPS	43,164.0	48,592.2	5,428.2	12.6
7682[W LEXNGT 345]	AMPS	12,689.3	14,207.3	1,508.0	11.9
7706[BROWN T1 138]	AMPS	42,223.0	47,121.0	4,898.0	11.6
7707[BROWN T2 138]	AMPS	42,233.6	47,132.5	4,898.9	11.6
7708[BROWN P 138]	AMPS	41,861.2	46,531.9	4,670.7	11.2

**Generation Interconnection Evaluation
Of a 750 MW Generating Power Plant
At Trimble County, KY**

7699[BROWN CT 138]	AMPS	41,724.8	46,357.4	4,632.6	11.1
7676[W LEXNGT 138]	AMPS	24,523.7	26,961.0	2,437.3	9.9
7635[W CLIFF 138]	AMPS	36,243.0	39,666.9	3,423.9	9.4
7634[WC-DD 138]	AMPS	35,954.2	39,319.6	3,365.4	9.4
7658[CLAYS ML 138]	AMPS	18,105.2	19,774.2	1,669.0	9.2
10003[11BUCKNR 345]	AMPS	28,281.8	30,793.1	2,511.3	8.9
7631[REYNOLDS 138]	AMPS	20,328.2	21,765.9	1,437.7	7.1
7638[LANSDWN 138]	AMPS	14,577.6	15,551.2	973.6	6.7
7728[ALCALDE 345]	AMPS	7,688.4	8,200.8	512.4	6.7
4749[SPEED 138]	AMPS	30,953.0	32,805.4	1,852.4	6.0
7780[MIDDLTWN 345]	AMPS	29,557.0	31,173.2	1,616.2	5.5
7636[PISGAH_2 138]	AMPS	18,732.7	19,662.4	929.7	5.0
923[CLIFTY 345]	AMPS	47,195.1	49,492.4	2,297.3	4.9

Table 6
Short Circuit Current
Option 3 - SLG Faults
Change in Fault Current less than 5% has been excluded

		Base	Option 1	Delta	Delta
		Amperes	Amperes	Amperes	Amperes %
7683 [W FRNKFT 345]	AMPS	6,311.3	10,077.2	3,765.9	59.7
7685 [BROWN N_ 345]	AMPS	11,608.1	16,927.2	5,318.1	45.8
4768 [SPEED 345]	AMPS	7,711.8	10,797.0	3,085.2	40.0
7795 [TRIMBLCO 345]	AMPS	39,545.6	52,405.9	12,860.3	32.5
7669 [W FRNKFT 138]	AMPS	15,628.6	17,772.3	2,143.7	13.7
7673 [GHENT_2 345]	AMPS	30,078.5	34,155.0	4,076.5	13.6
4734 [RAMSEY 345]	AMPS	5,566.2	6,257.5	691.3	12.4
4954 [RAMSEY 345]	AMPS	5,566.2	6,257.5	691.3	12.4
7639 [HIGBY ML 138]	AMPS	20,333.7	22,628.2	2,294.5	11.3
7682 [W LEXNGT 345]	AMPS	10,201.5	11,351.8	1,150.3	11.3
7659 [BROWN N 138]	AMPS	49,838.0	55,223.5	5,385.5	10.8
7676 [W LEXNGT 138]	AMPS	22,091.6	24,321.7	2,230.1	10.1
7706 [BROWN T1 138]	AMPS	48,113.8	52,720.5	4,606.7	9.6
7707 [BROWN T2 138]	AMPS	48,119.0	52,725.5	4,606.5	9.6
6437 [GAL. STE 345]	AMPS	21,813.6	23,875.4	2,061.8	9.5
4749 [SPEED 138]	AMPS	23,561.7	25,748.2	2,186.5	9.3
7684 [GALLT IN 345]	AMPS	21,094.8	23,018.1	1,923.3	9.1
7708 [BROWN P 138]	AMPS	47,537.4	51,850.4	4,313.0	9.1

**Generation Interconnection Evaluation
Of a 750 MW Generating Power Plant
At Trimble County, KY**

7699 [BROWN CT 138]	AMPS	47,549.5	51,843.6	4,294.1	9.0
7658 [CLAYS ML 138]	AMPS	14,538.0	15,548.1	1,010.1	6.9
7635 [W CLIFF 138]	AMPS	37,188.5	39,740.6	2,552.1	6.9
7634 [WC-DD 138]	AMPS	36,634.4	39,108.4	2,474.0	6.8
10003 [1BUCKNR 345]	AMPS	26,480.5	28,046.1	1,565.6	5.9
7631 [REYNOLDS 138]	AMPS	17,098.1	18,047.0	948.9	5.5
7728 [ALCALDE 345]	AMPS	6,855.8	7,190.3	334.5	4.9
7638 [LANSWDN 138]	AMPS	12,358.8	12,960.1	601.3	4.9

Table 7
Short Circuit Current
Option 4 - 3 Phase Fault
Change in Fault Current less than 5% has been excluded

		Base	Option 1 Delta	Delta	
		Amperes Amperes Amperes %			
7608 [HARDN CO 345]	AMPS	8,318.4	14,366.8	6,048.4	72.7
4768 [SPEED 345]	AMPS	10,317.2	15,101.3	4,784.1	46.4
7795 [TRIMBLCO 345]	AMPS	38,380.1	51,327.1	12,947.0	33.7
7669 [W FRNKFT 138]	AMPS	12,795.6	15,385.2	2,589.6	20.2
7704 [HARDN CO 138]	AMPS	14,378.2	17,216.8	2,838.6	19.7
4734 [RAMSEY 345]	AMPS	8,297.8	9,739.6	1,441.8	17.4
4954 [RAMSEY 345]	AMPS	8,297.8	9,739.6	1,441.8	17.4
7712 [ETOWN_2 138]	AMPS	12,996.4	15,132.2	2,135.8	16.4
7628 [TYRONE 138]	AMPS	14,074.5	16,301.1	2,226.6	15.8
7791 [MILL CRK 345]	AMPS	27,913.1	32,061.3	4,148.2	14.9
7673 [GHENT_2 345]	AMPS	25,265.0	28,773.6	3,508.6	13.9
7639 [HIGBY ML 138]	AMPS	22,417.8	25,095.4	2,677.6	11.9
6437 [GAL. STE 345]	AMPS	21,092.3	23,482.5	2,390.2	11.3
7684 [GALLT IN 345]	AMPS	20,847.7	23,180.0	2,332.3	11.2
10003 [11BUCKNR 345]	AMPS	28,281.8	31,191.7	2,909.9	10.3
7676 [W LEXNGT 138]	AMPS	24,523.7	26,982.0	2,458.3	10.0
7780 [MIDDLTWN 345]	AMPS	29,557.0	32,345.5	2,788.5	9.4

**Generation Interconnection Evaluation
Of a 750 MW Generating Power Plant
At Trimble County, KY**

7658 [CLAYS ML 138]	AMPS	18,105.2	19,610.9	1,505.7	8.3
7715 [ROGERSVL 138]	AMPS	6,844.4	7,392.4	548.0	8.0
7683 [W FRNKFT 345]	AMPS	7,489.1	8,083.4	594.3	7.9
7793 [BLUELICK 345]	AMPS	21,805.4	23,511.5	1,706.1	7.8
7603 [SMITH_2 345]	AMPS	12,999.6	14,013.7	1,014.1	7.8
7685 [BROWN N_345]	AMPS	13,193.5	14,196.0	1,002.5	7.6
4749 [SPEED 138]	AMPS	30,953.0	33,058.0	2,105.0	6.8
7631 [REYNOLDS 138]	AMPS	20,328.2	21,666.8	1,338.6	6.6
7638 [LANSDWN 138]	AMPS	14,577.6	15,483.2	905.6	6.2
7794 [PADDYWST 345]	AMPS	17,467.8	18,451.5	983.7	5.6
923 [CLIFTY 345]	AMPS	47,195.1	49,774.1	2,579.0	5.5
7682 [W LEXNGT 345]	AMPS	12,699.3	13,356.8	657.5	5.2
7636 [PISGAH_2 138]	AMPS	18,732.7	19,659.6	926.9	4.9

Table 8
Short Circuit Current
Option 4 - SLG Faults
Change in Fault Current less than 5% has been excluded

	Base Amperes	Option 1 Amperes	Delta Amperes	Delta Amperes %
7608 [HARDN CO 345]	6,954.1	10,712.4	3,758.3	54.0
4768 [SPEED 345]	7,711.8	10,814.1	3,102.3	40.2
7795 [TRIMBLCO 345]	39,545.6	52,659.5	13,113.9	33.2
7628 [TYRONE 138]	11,847.8	14,084.1	2,236.3	18.9
7704 [HARDN CO 138]	14,543.9	17,071.5	2,527.6	17.4
7669 [W FRNKFT 138]	15,628.6	18,301.2	2,672.6	17.1
4734 [RAMSEY 345]	5,566.2	6,261.2	695.0	12.5
4954 [RAMSEY 345]	5,566.2	6,261.2	695.0	12.5
7791 [MILL CRK 345]	32,023.7	35,824.9	3,801.2	11.9
7673 [GHENT_2 345]	30,078.5	33,456.3	3,377.8	11.2
7712 [ETOWN_2 138]	12,647.5	14,027.2	1,379.7	10.9
7639 [HIGBY ML 138]	20,333.7	22,502.9	2,169.2	10.7
4749 [SPEED 138]	23,561.7	25,851.4	2,289.7	9.7
7676 [W LEXNGT 138]	22,091.6	24,127.4	2,035.8	9.2
6437 [GAL. STE 345]	21,813.6	23,532.8	1,719.2	7.9
7684 [GALLT IN 345]	21,084.8	22,699.4	1,604.6	7.6
10003 [11BUCKNR 345]	26,480.5	28,265.8	1,785.3	6.7
7658 [CLAYS ML 138]	14,538.0	15,474.2	936.2	6.4

**Generation Interconnection Evaluation
Of a 750 MW Generating Power Plant
At Trimble County, KY**

7780 [MIDDLTWN 345]	AMPS	25,255.7	26,646.5	1,390.8	5.5
7683 [W FRNKFT 345]	AMPS	6,311.3	6,650.6	339.3	5.4
7715 [ROGERSVL 138]	AMPS	6,051.1	6,372.8	321.7	5.3
7631 [REYNOLDS 138]	AMPS	17,098.1	17,985.2	897.1	5.2
7685 [BROWN N_ 345]	AMPS	11,609.1	12,188.4	579.3	5.0
7638 [LANSDWN 138]	AMPS	12,358.8	12,928.4	567.6	4.6
7603 [SMITH_2 345]	AMPS	7,560.0	7,900.7	340.7	4.5

APPENDIX C

**Generation Interconnection Evaluation
Of a 750 MW Generating Power Plant
At Trimble County, KY**

Appendix C

Double Contingency Overloads

Double Contingency Analysis Summary

Base Case - 7 double contingencies that caused violations

Option 1 - 9 double contingencies that caused violations
Contingency #2275, 2988

Option 2 - 7 double contingencies that caused violations
NONE

Option 3 - 10 double contingencies that caused violations
Contingency #2275, 2475, 2988

Option 4 - 9 double contingencies that caused violations
Contingency #2275, 2988

List of New Outages in "Option 1" that are not present in Base Case

OPEN BRANCH FROM BUS 25405 [08KO WEB 230] TO BUS 25408 [08N LNDN 230] CKT 1	-----	CONTINGENCY LABEL 2275
OPEN BRANCH FROM BUS 25413 [08KOK HP 230] TO BUS 25616 [08KOKB7 999] CKT 1		
25392 08KOKB4I 999 25413 08KOK HP 230 1	-62.1	-97.5 75.0 130.1
25393 08KOKB5I 999 25413 08KOK HP 230 1	-62.5	-98.2 75.0 131.0

OPEN BRANCH FROM BUS 25403 [08LAP344 230] TO BUS 25408 [08N LNDN 230] CKT 1	-----	CONTINGENCY LABEL 2988
OPEN BRANCH FROM BUS 25405 [08KO WEB 230] TO BUS 25408 [08N LNDN 230] CKT 1		
25393 08KOKB5I 999 25413 08KOK HP 230 1	-62.5	-97.7 75.0 130.3

List of New Outages in "Option 2" that are not present in Base Case

None

Generation Interconnection Evaluation
Of a 750 MW Generating Power Plant
At Trimble County, KY

```

-----
List of New Outages in "Option 3" that are not present in Base Case
-----
OPEN BRANCH FROM BUS 25405 [08KO WEB 230] TO BUS 25408 [08N LNDN 230] CKT 1 ----- CONTINGENCY LABEL 2275
OPEN BRANCH FROM BUS 25413 [08KOK HP 230] TO BUS 25616 [08KOKB7 999] CKT 1 ----- CONTINGENCY LABEL 2275
25392 08KOKB4I 999 25413 08KOK HP 230 1 -62.3 -98.0 75.0 130.6
25393 08KOKB5I 999 25413 08KOK HP 230 1 -62.8 -98.6 75.0 131.5
25394 08KOKB6I 999 25413 08KOK HP 230 1 -62.2 -97.8 75.0 130.4
OPEN BRANCH FROM BUS 25413 [08KOK HP 230] TO BUS 25420 [08THRTWN 230] CKT 1 ----- CONTINGENCY LABEL 2475
OPEN BRANCH FROM BUS 25418 [08CLNTON 230] TO BUS 25419 [08MBSH R 230] CKT 1 ----- CONTINGENCY LABEL 2475
25420 08THRTWN 230 25625 08THRTWN 999 1 37.5 91.1 70.0 130.1
OPEN BRANCH FROM BUS 25403 [08LAF344 230] TO BUS 25408 [08N LNDN 230] CKT 1 ----- CONTINGENCY LABEL 2988
OPEN BRANCH FROM BUS 25405 [08KO WEB 230] TO BUS 25408 [08N LNDN 230] CKT 1 ----- CONTINGENCY LABEL 2988
25393 08KOKB5I 999 25413 08KOK HP 230 1 -62.8 -98.2 75.0 130.9

```

```

-----
List of New Outages in "Option 4" that are not present in Base Case
-----
OPEN BRANCH FROM BUS 25405 [08KO WEB 230] TO BUS 25408 [08N LNDN 230] CKT 1 ----- CONTINGENCY LABEL 2275
OPEN BRANCH FROM BUS 25413 [08KOK HP 230] TO BUS 25616 [08KOKB7 999] CKT 1 ----- CONTINGENCY LABEL 2275
25392 08KOKB4I 999 25413 08KOK HP 230 1 -62.2 -97.8 75.0 130.3
25393 08KOKB5I 999 25413 08KOK HP 230 1 -62.7 -98.4 75.0 131.3
25394 08KOKB6I 999 25413 08KOK HP 230 1 -62.1 -97.6 75.0 130.1
OPEN BRANCH FROM BUS 25403 [08LAF344 230] TO BUS 25408 [08N LNDN 230] CKT 1 ----- CONTINGENCY LABEL 2988
OPEN BRANCH FROM BUS 25405 [08KO WEB 230] TO BUS 25408 [08N LNDN 230] CKT 1 ----- CONTINGENCY LABEL 2988
25393 08KOKB5I 999 25413 08KOK HP 230 1 -62.7 -97.9 75.0 130.6

```

APPENDIX D

First Contingency Transfer (FCITC) To a Generator Bus in The LGEE Area

LGEE Generators	Base MW	Option 1 MW	Option 2 MW	Option 3 MW	Option 4 MW
Ghent	NP	NP	NP	NP	NP
Mill Cr	NP	NP	NP	NP	250/ NP see note 2
Trimble	NP	NP	NP	NP	NP
Brown CT	NP	NP	NP	NP	NP
Cane Run	NP	NP	NP	NP	NP
Gr. River	NP	NP	NP	NP	NP
Paddy Run	NP	NP	NP	NP	NP
Smith	NP	NP	NP	NP	NP
Tyron	NP	NP	NP	NP	NP
Buckner	NP	NP	NP	NP	NP

Note -

1. NP = No Problem
2. Limiting Elements are Middletown 345 KV to Buckner 345 KV and/or Middletown 345 KV to Trimble 345 KV

Report

**Project G218 (MISO Queue #37356-01)
Generation Interconnection Evaluation of a 750 MW
Generating Power Plant at Trimble County, KY**

Volume 2 (Appendices E - J)

Prepared By

**Engineering Department
Midwest ISO
701 City Center Dr.
Carmel, IN 46032**

March 11, 2003

APPENDIX E

Generation Interconnection Evaluation
Of a 750 MW Generating Power Plant
At Trimble County, KY

Positive Sequence Equivalent Fault Impedance Data (mho)

Fault Definition	Base	Option 1	Option 2	Option 3	Option 4
Faults at Trimble (#7795) 345 KV Station	8.0674; -119.7002	9.0172; -150.8468	8.0574; -141.4251	9.8948; -158.4263	10.0284; -158.9947
Faults at Clifty (#923) 345 KV Station	11.1950; -129.8118	11.8352; -132.9111	11.6047; -131.8981	11.8658; -133.1565	11.9658; -133.5608
Faults at Middletown (#7780) 345 KV Station	10.6132; -69.3946	11.1374; -71.1117	11.2737; -71.5303	11.1436; -71.0885	11.4884; -72.0891
Faults at W. Frankfort (#7683) 345 KV Station	2.3973; -17.2798	4.3582; -36.3235	3.3313; -26.5656	3.3533; -26.6258	2.4980; -18.0386
Faults at Brown (#7685) 345 KV Station	3.9070; -32.3417	5.2423; -49.8476	5.1461; -49.0154	5.0182; -48.0856	4.1085; -33.5970
Faults at Mill Creek (#7791) 345 KV Station	6.0931; -103.0822	6.2585; -104.1791	7.2627; -113.2823	6.2153; -103.8592	7.3062; -113.2221
Faults at Harding County (#7608) 345 KV Station	2.4233; -18.9247	2.5388; -19.4702	3.4085; -28.0885	2.5275; -19.3872	3.3018; -27.6953
Faults at Ghent (#7673) 345 KV Station	5.2755; -99.1636	5.9339; -107.6056	5.5587; -103.0468	6.0683; -110.3958	5.9059; -108.5533
Faults at Speed (#4768) 345 KV station	2.7316; -20.2659	2.7417; -20.3121	2.7385; -20.2958	4.0976; -27.9368	4.1069; -27.9648
Faults at W. Lexington (#7682) 345 KV Station	4.5809; -27.2577	5.2232; -31.4194	5.2022; -30.2938	5.1906; -30.2370	4.6736; -28.2035